

SYSTEM ANALYST DOS-M COURSE

JANUARY 1971

SYSTEM ANALYST DOS-M COURSE OUTLINE

- I. INTRODUCTION
 - A. Minimum Hardware Requirements
 - B. Advantages and Disadvantages (Compared to DOS)
 - C. IOMEC Overall Description
 - D. DOS-M Software
 - E. System Startup Description
 - F. DOS-M I/O Request Processing

- II. OPERATIONAL DIFFERENCES FROM DOS
 - A. System Startup
 - B. New Directives
 - C. Operational Difference Summary

- III. PROGRAMMING DIFFERENCES FROM DOS
 - A. New EXEC Call
 - B. Negative Request Codes
 - C. EXEC Calls Difference Summary
 - D. Other Important Points

- IV. INSTALLATION
 - A. Introduction to Generation
 - B. System Generation Procedure and Example
 - C. Formatting User Discs and Cartridges

- V. INTERNAL SYSTEM ORGANIZATION
 - A. Disc File(s) Format
 - B. Disc Dump of Generation Example
 - D. System Base Page Communication Area Description

- VI. INTERNAL SYSTEM OPERATION
 - A. Iomec Command Sequences
 - B. Supplied DOS-M Bootstrap
 - C. Disc Resident Bootstrap
 - D. DOS-M System HALTS
 - E. I/O Request Processing Example

- VII. DOS-M FLOWCHARTS

I. INTRODUCTION

A. Minimum Hardware Requirements

1. Why DOSM?
2. DOS/DOSM minimum hardware [SLIDE 1]
3. Cost Comparison
4. Comparison to competitor - (IBM 1130) [SLIDE 1A]
5. DOSM Hardware options [SLIDE 1B]

B. Advantages and Disadvantages [SLIDE 2]

I. ADVANTAGES (Special Points)

- a. Another cabinet and power supply needed when number of drives is expanded to 3 or 4.
- b. User could operate in his own instrument driver environment if no MP (Memory Protect).
- c. If User does not want EAU or clock, he is not forced to have it. Gains one more I/O channel without TBG option.
- d. Easy creation of System Backup (which will not be hardware protected) on Cartridge.
- e. Multiple System Discs with different configurations on separate drives.
- f. Exchange of user files between systems even though systems may be configured differently.
- g. Hardware protection scheme using DISC PROTECT OVERRIDE SWITCH and PCI (Protected Cylinder Indicator).
- h. Operation with USER DISCS Labeled to avoid using incorrect cartridge.
- i. Minimum core resident system reduced from DOS (DVR05 and DVR31 changes).

2. DISADVANTAGES (Special Points)

- a. Three bootstraps (cover details later).
Method of System Start-up.
- b. No plans at present for moving head RTE or TSB. Some talk for ISS system (ISS disc cost about \$ 35,000 and has about 12 million word storage).
- c. Better to lose sale rather than deliver an 8K system that will "strangle" customer's programs (during loading or execution). Just because JOBPR will fit is not any indication that system will be adequate.

C. IOMEC Overall Description

1. CONTROLLER [SLIDE 3]

- a. Interface between computer and drive(s).
- b. Interface cards on computer side.
 - (1) Identical electronically except for positions of jumper wires.
 - (2) Signals inverted from positive-true/ground-false logic to ground-true/positive-false to be compatible with controller.
 - (3) DATA CHANNEL - Transfers data, status, and addressing information. DMA controls data; program controls status and addressing.
 - (4) COMMAND CHANNEL - Transfers commands, drive selection, and drive attention bits (LSB). All under program control.

2. DRIVE (Maximum of 4 per controller)
 - a. Fixed Disc and Removable Cartridge.
 - b. Movable heads and their numbers.
 - c. Power ON/OFF.
 - d. Cartridge LOCK/UNLOCK and light.
 - e. READY light.
 - f. Physical description of PACK.
 - (1) Opening at rear for heads entry.
 - (2) Opening underneath for forced air.
 - (3) Rim markers for TRACK/SECTOR origins.

3. DISC

- a. Physical storage capacity breakdowns [SLIDE 4].
- b. Physical layout [SLIDE 5].
- c. Addressing [SLIDE 6].
 - (1) Physical (Drive, Cylinder, Head, Sector).
 - (2) Logical (Subchannel, Track, Sector).
Software inverts (complements) lower order bit of subchannel # for higher order bit of head #.
- d. Sector Address and Data Fields [SLIDE 7].
 - (1) INITIALIZE WRITE COMMAND is used for controller to construct and write the Sector Address Field with PCI=DCI=0 (only disc formatting section of generator does this).
 - (2) WRITE PROTECTED COMMAND is used for controller to set PCI=1 in Sector address field (only generator does this).
 - (3) WRITE DEFECTIVE COMMAND is used for controller to set DCI=1 in Sector Address Field. Only \$EX20 makes this call (DVR31 will accept under system operation).

(Continued)

- (4) Controller does not send back any status on PCI or DCI if DISC PROTECT OVERRIDE SWITCH is "ON" (i.e. UP). This switch must be "ON" when executing (1), (2), or (3) on the preceding page!

D. DOSM Software and Relationship to Discs

1. Components [SLIDES 8A, 8B, 8C, 8D].
2. Disc to Memory Transfers [SLIDE 9].
3. DOSM General Core Layout [SLIDE 10A].
 - a. EQT Format [SLIDE 10B].
 - b. DRT Format [SLIDE 10C].
 - c. INT Table Format [SLIDE 10D]
4. Discs Layout
 - a. Concept of "SYSTEM" and "USER" Discs.
 - b. Oversimplified "SYSTEM" disc layout [SLIDE 11A].
 - c. More detailed "SYSTEM" disc layout [SLIDE 11B].
 - d. User disc layout [SLIDE 11C].
 - e. Label Sectors
 - (1) System Disc [SLIDE 12A].
 - (2) User Disc [SLIDE 12B].

E. System Startup Operation Example with block diagrams.

1. Execution of Configured Supplied Bootstrap [SLIDE 13A.1].
 - a. Loads Disc Resident Bootstrap into high core, relocating it as necessary.
 - b. Transfers control to start of DRB just loaded.

(Continuation)

- E. SYSTEM Startup Operation Example with block diagrams.
2. Execution of Disc Resident Bootstrap [SLIDE 13A.2].
 - a. Loads Core Resident System from System Disc in four parts.
 - b. Configures continuator section of DVR05 and DVR31.
 - c. Transfers control to \$STRT in DISC MONITOR by JMP 3,1.
 3. Disc Monitor First Entry [SLIDE 13A.3].
 - a. \$STRT calls \$MDLD to transfer control to \$EX12 (System Startup).
 - b. \$MDLD makes decision whether to load \$EX12 from Disc (if Disc Resident) then transfers control to \$EX12.
 4. Execution of \$EX12 [SLIDE 13A.4].
 - a. Sets (MP FENCE ADDRESS = UMFWA) with OTA 5.
 - b. Reads System Buffer Sector to Base Page.
 - c. Builds new System Buffer Sector and writes back on disc if not valid one (i.e., does not end with "SB").
 - d. Calls \$SYIO to output "INPUT :DATE,XXXXXX,H,M" on System TTY.
 - e. Sets input request code = "DA" and transfers control to \$TYPE for System K.B. Input.

5. Execution of \$TYPE for System K.B. Input [SLIDE 13A.5].
 - a. Calls \$SYIO to output (CR) (LF) ⓐ.
 - b. Calls \$SYIO to input 72 characters into JOB INPUT BUFFER.
 - c. \$SYIO calls \$TEST routine to force :DA input.
 - d. If :DA not inputted, calls \$SYIO to output "IGNORED" and goes to b. above.
 - e. If :DA inputted, transfers control to \$JLOD to load and branch to JOBPR.
6. Execution of \$JLOD to load JOBPR [SLIDE 13A.6].
 - a. \$JLOD calls DISCX twice to read in JOBPR (MAIN and Base Page) and then transfers control to JOBPR main entry point.
 - b. Each call to DISCX results in call to \$DISC which in turn calls \$SYIO to read DISC.
7. Execution of JOBPR to Update System Buffer Sector [SLIDE 13A.7].
 - a. Date routine in JOBPR reads System Buffer Sector from Disc to its own internal buffer by JSB EXEC call.
 - b. Updates DATE, LU TABLE entries, and Default User Label in System Buffer Sector.
 - c. Writes updated System Buffer Sector back on Disc by JSB EXEC call.
8. Execution of JOBPR to report Default USER DISC SUBCHANNEL # and LABEL [SLIDE 13A.8].
 - a. Date Routine continues by executing EXEC call to request CURRENT USER DISC SUBCHANNEL # and LABEL.
 - b. \$EXI7 is used just as if :UD directive had been entered.

- c. Point out that if GENERATION CODE or PROPRIETARY CODE do not agree with System Disc, ERROR MESSAGE may be printed here.
 - d. At end JOBPR then calls \$TYPE for System TTY to output $\text{\textcircled{CR}}$ $\text{\textcircled{LF}}$ and @ and to input from Keyboard.
9. Summary of 1-8 above.
- a. JOBPR is a USER PROGRAM and must do all I/O by JSB EXEC.
 - b. At end of 8 above, the JOBPR remains in memory until :PROG,X entered or :OFF given in response to * (here \$CLER loads JOBPR fresh).
 - c. No part of Core Resident System ever does any I/O by JSB EXEC; always does by \$SYIO.
 - d. MP and Interrupt System "ON" when in USER AREA. MP and Interrupt System "OFF" when in System Area.
 - f. DOSM I/O REQUEST PROCESSING [LARGE CHART].

II. OPERATIONAL DIFFERENCES FROM DOS

A. System Startup

1. Bootstrap rather than BBDL (at X7760).
 - a. DOS procedure using BBDL.
 - b. DOSM procedure using Bootstrap [SLIDES 14A & 14B].
 - (1) Configure and execute.
 - or (2) Configure, punch configured bootstrap, load configured bootstrap.
 - c. No "FR" or "CO" entry statement as in DOS.

B. NEW DIRECTIVES

1. :OFF [SLIDE 15].
 - a. Does not clear Job Binary Area.
2. :IN [SLIDE 16A & 16B]
 - a. Can prepare discs for use in DOSM that were formatted by other software
 - b. DISC PROTECT OVERRIDE SWITCH must be "ON" to purge a protected Disc (PCI=1).
3. :UD [SLIDES 17A, 17B].
4. :DD [SLIDE 18].
 - a. No SDUMP with DOSM; do not need!
 - b. Source Disc for User Area is current user disc.
5. :SS [SLIDES 19A, 19B].
 - a. Duplicate file handling
6. Example Slides using the above directives. [SLIDES 20A, 20B, 20C].

- C. Operational Difference Summary [SLIDES 21A, 21B, 21C, 21D].

III. PROGRAMMING DIFFERENCES FROM DOS

- A. New EXEC call to change user disc [SLIDES 22A, 22B, 22C].
 - 1. :EJOB resets changes made.
 - 2. Error messages if incorrect SYSTEM GENERATION or SYSTEM PROPRIETARY CODE, but assignment still made.
- B. DOS/DOSM EXEC calls with negative request codes [SLIDE 23A].
- C. DOSM Disc I/O with EXEC calls [SLIDE 23B].
- D. EXEC calls difference summary [SLIDE 24].
- E. Other important points.
 - 1. If MP option not used the following are valid.
 - a. All I/O instructions and HALT
 - b. Base page modifications.
 - c. Special interaction with DISC MONITOR (DISCM).
 - 2. LOADR is unaffected by :SS condition. File searches it initiates are for only current user disc. Order of scanning is:
 - a. JOB BINARY (if any programs in it)
 - b. USER FILES (if any given)
 - c. PAPER TAPE (if specified)
 - d. DISC RESIDENT RELOCATABLE LIBRARY

IV. INSTALLATION

A. Introduction to System Generation.

1. Binary tapes needed [SLIDES 30A, 30B].

2. Preliminary Considerations

a. Medium of Input

(1) Paper tape.

(2) Magnetic tape (restrictions with FORTRAN IV in 8K).

(3) Combination

b. Core size [SLIDE 31] -- GENERAL (Projecture #1)

(1) Speed of System Operation needed.

(2) Core Resident versus Disc Resident EXEC Modules and I/O Drivers.

(3) System Modules size breakdown [SLIDE 32] (Projecture #2).

a. Minimum System Analysis using slides 31 and 32.

c. Particular needs for given application.

d. System and User Disc subchannel declaration.

(1) More efficient (time wise) if System and User Discs are on different drives, depending on what System is doing.

e. Other System Discs considerations.

(1) If both generated so that linkage and DISCM are in same place, then user main programs LOADED on one system would "RUN" and be compatible with the other. Location of EXEC entry in DISCM must be same; # links must be enough; Etc...

f. Hardware required for Generation.

3. Starting System Generator

a. SIO Configuration - loading Generator.

b. All equipment to be used "ON".

c. Disc Drive for Generated system "READY".

d. Disc Protect Override Switch "ON".

e. Starting Generator (S.A. = 100 octal).

(1) Switch 15 DOWN for Straight Generation.

(2) Switch 15 UP only for User Disc Formatting.

4. Brief description of the four PHASES and ability to restart at any one at 100 octal.

B. System Generation Procedure and Example

1. Initialization Phase [SLIDE 40A].

a. Responses to questions about the System (in general) to be generated.

b. System Generation Code - maximum 4 decimal positive digits. Written in Label Sector of System Disc.

c. # Sectors/Track - Actually # Sectors/Physical track which is 12 for low density disc.

d. System Disc Size - actually # cylinders.

e. First System Sector - System uses first 3 sectors on track 0 of System Disc.

f. 2114 question - only for DMA considerations (only one DMA Channel available on 2114B).

g. Program Input, Library Input questions - Unimportant whether PT or MT entered here

(1) MT may not be used for FORTRAN IV in 8K.

(2) DF also valid entry for disc file input.

(SIO driver for IOMEC available later).

- h. Parameter Input question - only applies to
PARAMETER INPUT PHASE.
3. Program Input and Parameter Input Phases
[SLIDE 40B].
- a. Input device selected via S.R. switches 0-1.
 - 00₂ - PROGRAM INPUT
 - 10₂ - LIBRARY INPUT
 - 01₂ - TERMINATE LOADING
 - b. Restrictions
 - (1) DISCM should be loaded first for intersystem compatibility.
 - (2) Main Programs (like FTN) must be loaded prior to segments (like FTN01, FTN02, ... etc.)
 - (3) If generating 8K system with FORTRAN IV no Compilers, or Assembler may be loaded at this time. (Must be loaded using LOADR during System operation).
 - c. If undefined externals exist (message printed), may load module forgot by setting S.R. accordingly as in a. above and pressing "RUN".
 - d. During PARAMETER INPUT PHASE, be sure to declare other routines (\$SRCH, \$LBL, etc...) core resident too if certain EXEC modules are declared core resident. Generator will not flag if omitted.
 - e. LINKAGE QUESTIONS
 - (1) #SYSTEM LINKS - only used by Core Resident System.
 - (2) #USER LINKS - only used by User Programs
 - (3) To make DISCM start at 2000 octal (page boundary) respond with 177 and 500 respectively.

- f. Switch 15 must be up for Subroutines (indented two spaces) and entry points (preceeded by "*") to be printed in memory allocation listing.

3. Disc Loading Phase (class follows Xerox of Generation).

<u>TOPIC</u>	[SLIDE] <u>MAIN PROJECTOR</u>	[SLIDE] <u>AUXILIARY PROJECTOR</u>
a. Links -----	AP-1-----	
b. Loc. 4-Start of Links-	AP-1-----	AP-6
c. Core Res Prog & Links-	AP-1-----	AP-13
d. Equip. Table-----	AP-1,AP-2-----	AP-14
e. DRT + Int. Tables-----	AP-1,AP-3-----	AP-14
f. Disc Res. Exec Mod.---	AP-1,AP-4-----	AP-14
TABLE		
g. Disc Res Exec. Mod.---	AP-1-----	AP-5
h. Disc Res. I/O Drivers-	AP-1-----	AP-5
i. Disc Res User Prog.---	AP-1-----	AP-5
j. Value of A-Reg. at end (do on slide 40J)		
k. Listing of :EQ & :LU [SLIDE AP-5]		

C. Formatting User Discs or Cartridges [SLIDE 41].

- 1. Example printout [SLIDE 42].

V. INTERNAL SYSTEM ORGANIZATION

A. Format for Disc Files

- (1) Absolute (Core Image) [SLIDE 43].
- (2) Relocatable [SLIDE 44].
- (3) ASCII Source Statements [SLIDES 45A, 45B].
- (4) ASCII or Binary Data.
 - a. System simply reserves space - does not set initial file contents to any value(s).

B. Disc Layout for Generation Example

<u>TOPIC</u>	<u>MAIN PROJECTURE</u>	<u>AUX. PROJECTURE</u>
Overall Disc Layout	50	-----
System Label Sector	51	AD-1
Disc Resident Bootstrap	50	AD-1
System Directory	50,52	AD-1 → AD-3
Core Res. Sys. (#2)	50,53	AD-3 → AD-10
Core Res. Sys. (#3)	50,54,55	AD-10
Disc Res. Programs	50,56	AD-10 → AD-24
Core Res. Sys. (#4)	50,57,58	AD-25
Core Res. Sys. (#1)	50,58	AD-26 → AD-27
User Label Sector	50,59	AD-28
User Directory	50,60,61	AD-28 → AD-29

C. Detailed Description of System Base Page Communication Area. (Found in Appendix A of Operators' Manual). Description starts on next page. Slides AP-1 (General Core Layout) and AP-6 (Low Core of Memory Dump) will be used to relate values where possible.

DOS-M BASE PAGE LOCATIONS

<u>LOCATION (S)</u>	<u>TYPE</u>	<u>CONTENTS</u>
3	--	Start address for System Start-up (branched to indirect by Disc Resident Bootstrap following loading of Core Resident System).
4-37	--	JSB N,I where N is a Base Page Location containing the Central Interrupt Controller (\$CIC) address.
40	DEC	-64 (177700)
41	DEC	-10 (177766)
42	DEC	-9 (177767)
43	DEC	-8 (177770)
44	DEC	-7 (177771)
45	DEC	-6 (177772)
46	DEC	-5 (177773)
47	DEC	-4 (177774)
50	DEC	-3 (177775)
51	DEC	-2 (177776)
52	DEC	-1 (177777)
53	DEC	0 (0)
54	DEC	1 (1)
55	DEC	2 (2)
56	DEC	3 (3)
57	DEC	4 (4)
60	DEC	5 (5)
61	DEC	6 (6)
62	DEC	7 (7)
63	DEC	8 (10)

<u>LOCATION</u>	<u>TYPE</u>	<u>CONTENTS</u>	
64	DEC	9	(11)
65	DEC	10	(12)
66	DEC	17	(21)
67	DEC	64	(100)
70	OCT	17	(17)
71	OCT	37	(37)
72	OCT	77	(77)
73	OCT	177	(177)
74	OCT	377	(377)
75	OCT	177400	(177400)
76	OCT	3777	(3777)
77	OCT	177700	(177700)

<u>LOCATION</u>	<u>LABEL</u>	<u>CONTENTS</u>
100	UMLWA	Last word address of user available memory. Will always be one less than contents of location 123.
101	JBINS	Start TRACK/SECTOR of job binary area. =0 if job binary area not assigned. =-1 if this area overflows during compilation or assembly. = TRACK/SECTOR at end-of-disc for area assigned.
102	JBINC	Current TRACK/SECTOR of job binary area. Only set by compilers or assembler using this area.
103	TBG	Time Base Generator I/O Channel address. Will be 0 if TBG not on system.
104	CLOCK	Minutes part of System Time Clock.
105	CLOCK+1	Tenths of seconds part of System Time Clock.
106	CLEX	Minutes part of execution Time Clock. Bit 15 is set "ON" to turn this clock off.
107	CLEX+1	Tenths of seconds part of Execution Time Clock.
110	CXMX	Maximum allowable execution time. Set by :RUN Directive time parameter or to 5 if not given.

<u>LOCATION</u>	<u>LABEL</u>	<u>CONTENTS</u>
111	BATCH	Logical Unit # of Batch Input Device. Set by :BATCH Directive.
112	SYSTY	Logical Unit # of System Teletype.
113	DUMPS	Abort/Post Mortem dump flags. Bit 15 --- Abort dump flag. Bit 0 --- Post mortem dump flag. Bit will be on if condition set. These bits will be set by :ADUMP and :PDUMP Directives and cleared by either their execution, :OFF Directive, or new :JOB Directive.
114	SYSDR	System Directory start TRACK/SECTOR. Set to where system is declared as starting during generation.
115	SYSBF	System Buffer TRACK/SECTOR. Since always on track boundary, sector part will always be 0.
116	SECTR	Number of <u>logical</u> sectors per disc track.
117	EQTAB	Start Address of Equipment Table.
120	EQT#	Number of entries in entire Equipment Table. Each entry is 17 words.
121	LUTAB	Start address of Logical Unit Table.
122	LUT#	Number of entries in Logical Unit Table.
123	JBUF	Start address of Job Input Buffer.
124	JFILS	Start TRACK/SECTOR address of source file. Set by execution of :JFILE Directive.

<u>LOCATION</u>	<u>LABEL</u>	<u>CONTENTS</u>
125	JFILC	Current TRACK/SECTOR address of source file. Updated as Compiler or Assembler accesses the source file.
126-140	RONBF RONBF+1 ⋮ RONBF+10	Multi-purpose 11 word buffer used by system when user program is executing. Some uses are: (1) Saving of two 5 word user File directory entries to increase system efficiency when user program is running on only one subchannel. System looks here first for Directory entry before searching Disc Directory. (2) Contains actual parameter values (P1,P2,...) following :PROG, and :GO directives. (3) Information is passed to \$EX20 (Parity Error Processor) by these locations.
141-153	EXPG ⋮ EXPG+10	Directory Entry for currently executing USER program. For MAIN programs having segments: The first 2 1/2 words will always be those of the MAIN program's Directory entry (File Name in ASCII) with the remaining 8 1/2 words equal to the segment currently executing Directory entry information.
154	DISCO	Bits 11-15 (Disc Data Channel select code). Bits 0-10 (Last Track on System).
155	SYSSC	System Disc Subchannel number. Will always be equal to S.C. bootstrapped down from.

<u>LOCATION</u>	<u>LABEL</u>	<u>CONTENTS</u>
156	SCCNT	Number of Subchannels on System -1.
157	UDNTS	Next TRACK/SECTOR address on Current User Disc.
160	SYNTS	Next TRACK/SECTOR address on System Disc. Will always equal the start of Work Area.
161	CUDSC	Current User Disc subchannel number.
162	CRFLG	Current Disc request flag. (0 for System Disc; ≠0 for Current User Disc). DVR31 always clears on completion of Disc request and examines on entry to see what disc to access.
163	CUDLA	Current User Disc TRACK/SECTOR address last accessed. Only used by DVR31.
164	SDLA	System Disc TRACK/SECTOR address last accessed. Only used by DVR31.
165	CUMID	Computer identification code. (≠0 if computer is 2114B thus only having one DMA channel).
166-170	DBUFR	System Disc Request Parameter Buffer. DBUFR = TRACK/SECTOR DBUFR+1 = BUFFER ADDRESS DBUFR+2 = NUMBER OF WORDS (Set by System prior to Disc I/O for DVR31 to use).

LOCATION	LABEL	CONTENTS
171-173	UBUFR	Current User Disc Request Parameter Buffer. UBUFR = TRACK/SECTOR UBUFR+1 = BUFFER ADDRESS UBUFR+2 = NUMBER OF WORDS (set by System prior to Disc I/O for DVR3I to use).
174	TSONE	Last referenced TRACK/SECTOR address +1. Set by DVR3I. Could be used by User program accessing the WORK AREA to see what next available TRACK/SECTOR address is.
175	GUDSC	Default User Disc Subchannel number. Always follows System Disc Subchannel number when Default User Disc is on same subchannel as System. (like when :DD executed), otherwise it stays where started W.R.T. Bootstrapped System.
176	SYSCD	System Generation Code.
177	JFLSC	Current Source File Subchannel number. Set by :JFILE Directive.
200	DISCL	User label TRACK/SECTOR address. =0 if Current User Disc is not on System Disc. If Current User Disc is on System Disc this Disc address = System Buffer Sector address. Incrementing this Disc address by one sector always gives the start of the User Directory TRACK/SECTOR address on the Current User Disc.

<u>LOCATION</u>	<u>LABEL</u>	<u>CONTENTS</u>
201	INTAB	Start address of Interrupt Table.
202	INT#	Number of Interrupt Table entries.
203-223	EQT1 EQT2 ⋮ EQT17	Addresses of <u>Current Equipment Table Entry</u>
224	RQCNT	Number of request parameters in current EXEC call. JSB EXEC and DEF RTN are not counted.
225	RQRTN	Request return address in current EXEC call.
226-235	RQPI RQP2 ⋮ RQP8	Addresses of current request parameters. RQPI is for the request code address etc.
236	NABRT	Illegal request code abort/no abort option parameter. ≠0 if set. Set by N parameter in :RUN Directive.
237	XA	A Register contents at time of interrupt.
240	XB	B Register contents at time of interrupt.
241	XEO	E (Bit 15) and O (Bit 0) Register contents at time of interrupt.
242	XSUSP	Address at time of Interrupt (P-Register)
243	EXLOC	Start address of EXEC MODULE DOUBLET TABLE

<u>LOCATION</u>	<u>LABEL</u>	<u>CONTENTS</u>
244	EX#	Number of entries in EXEC MODULE DOUBLET TABLE.
245	EXMOD	EXEC MODULE currently in EXEC MODULE overlay area. = 0 if none resident. = +N if module #N resident and available. = -N if module #N resident and BUSY.
246	EXMAN	EXEC MODULE overlay area <u>low</u> Main Core Address.
247	EXMAN+1	EXEC MODULE overlay area <u>high</u> Main Core Address.
250	EXBAS	EXEC MODULE Base Page linkage <u>low</u> address.
251	EXBAS+1	EXEC MODULE Base Page linkage <u>high</u> address.
252	IODMN	START ADDRESS OF I/O Driver Main overlay area.
253	IODBS	Start address of I/O Driver Base Page overlay area.
254	UMFWA	Start address of User Main Area.
255	UBFWA	Start address of User Base Page Linkage Area.
256	UBLWA	Last word address of User Base Page Linkage Area.
257	CHAN	Current DMA channel number assigned. = 0 if no DMA in use.

<u>LOCATION</u>	<u>LABEL</u>	<u>CONTENTS</u>
260	OPATN	Operator attention flag. = 0 for not set. ≠ 0 if desired. Set by System TTY Driver.
261	OPFLG	System TTY busy flag. = 0 if not busy. ≠ 0 if busy.
262	SWAP	Job Processor resident flag. BIT 15 = 1 if System TTY is Batch Device. BIT 0 = 1 if Job Processor is in core.
263	JOBPM	Job Processor start TRACK/SECTOR address.
264	JOBPM+1	# of words in MAIN section of Job Processor.
265	JOBPB	# of words in Base Page Linkage for Job Processor.
266	EJOBFL	End-of-Job flag used only by Job Processor. = "blanks" if re-entry of :DATE allowed = 0 if in a job. = 1 if between jobs. = -1 if end-of-job.
267	RTRK	Real Time simulation track #.
270-467	\$BUF \$BUF+1 ⋮ \$BUF+127	128 Word System I/O Buffer. Used only by Monitor and EXEC modules.
470	\$GOPT	Point of suspension return address. Contains return address when \$IDCD (location 471 below) = GO

<u>LOCATION</u>	<u>LABEL</u>	<u>CONTENTS</u>
471	\$IDCD	Input request code check characters. = 0 for no special restrictions. ≠ 0 for special restrictions placed on what can be entered via system TTY keyboard (like DA, GO, etc...).
472-473	\$MDBF	2 Word EXEC Module Data Buffer.
474-502	TEMP TEMP+1 ⋮ TEMP+6	System Temporary.
503	TEMP0	System Temporary.
504	TEMP1	System Temporary.
505	TEMP2	System Temporary.
506	TEMP3	System Temporary.
507	TEMP4	System Temporary.
510	TEMP5	System Temporary.
511	MSECT	Negative # of logical SECTORS per TRACK.
512	VADR	Address of last instruction that caused a memory protect violation.
513	IODMD	I/O Driver Overlay Area resident flag. = 0 if no I/O Driver in this area. ≠ 0 if an I/O Driver is in this area. The value (if not 0) will be: + (Address of resident Driver's first EQT entry) if area is available OR - (Address of resident Driver's first EOT entry) if this area is not available

514	RCODE	Current request code value. Will always be positive.
515	SXA	Operator attention A Register save.
516	SXB	Operator attention B Register save.
517	SXEO	Operator attention E (Bit 15) and 0 (Bit 0) Register save.
520	SXSUS	Operator attention return address save (P-Register).
521	SEQTI	Operator attention EQT Table address save.
522	DSCLB	Disc TRACK/SECTOR Address of Disc Resident Relocatable Library. Used by Relocating Loader.
523	DSCL#	Number of sectors in Disc Resident Relocatable Library.
524	LSTCH	Last Disc referenced flag. = 0 if current user program (to be executed by :PROG or :RUN) is on System Disc. ≠ 0 if current user program (to be executed by :PROG or :RUN) is on Current User Disc.

NOTE: \$EX10 (Program Load) uses to see how to set CRFLG flag (location 162).

525	FLFLG	User file table validity flag. (= 0 if invalid; ≠ 0 if valid). \$EX11 uses to see if OK to use \$BUF area for user file directory entry storage.
-----	-------	--

<u>LOCATION</u>	<u>LABEL</u>	<u>CONTENTS</u>
526	XFLG	<p>Transfer Address for Disc Not Ready condition.</p> <p>= Ø to process Not Ready condition normally.</p> <p>≠ Ø to transfer to this address if Not Ready condition present.</p> <p>A good use is to ignore "NOT READY" Drives when doing multiple Drive System Searches.</p>
527	SSFLG	<p>System Search Flag</p> <p>Values it can have are:</p> <ol style="list-style-type: none"> ASCII "NO" if :SS Directive not allowed. Ø for only current user Disc (:SS,99 condition). -X for full System Search (:SS) where X= # subchannels on system -1. +X for Selected System Search Bits Ø-7 are used to represent Subchannels Ø-7 respectively. Bit ON=OK, Bit OFF=not OK.
530-531	CHARC	System Temporary.

VI. INTERNAL SYSTEM OPERATION

A. TOMEQ Command Sequences

1. Seek Record [SLIDE 69A]
2. Read Data [SLIDE 69B]
3. Write Data [SLIDE 69C]
4. Check Data [SLIDE 69D]
5. Status Check [SLIDE 69E]
6. Constants and Storage [SLIDE 69F] -- Second Projector

B. Supplied DOS-M Bootstrap Listing Study ("A" Version)

1. Configuration Section (Start Address =2) [SLIDES 70D - 70F]
 - a. Data Channel In Switches 0-5
 - b. Configure DMA Control Word
 - c. Loop to Configure all D.C. and C.C. Instructions
 - d. Switch 15 Down -- HALT
Switch 15 UP -- Punch Configured Bootstrap in absolute tape format.
2. Execution Section (Start Address =100B or 5) [SLIDES 70A-70C]
 - a. Loads Disc Resident Bootstrap form Track 0 Sectors 1 & 2 on Subchannel specified to memory locations 15400 - 15777 octal.
 - b. Sets locations in DRB as follows:
 - 15771 ← 0.
 - 15772 ← Head # (Bits 8-9).
 - 15776 ← System Disc Drive #.
 - 15773 ← Data Channel I/O select code for
 - 15774 Run Time Disc.
 - 15775 ← Command Channel I/O select code for Run Time Disc.
 - c. Uses address in ASPBF of DRB (which was set earlier during generation) to see what page LWAM declared in adjusts for one page lower for relocation of Disc Resident Bootstrap.
 - d. Adjusts DEF's in DRB for correct page (ASPBF, DEFDY, and DVADR).
 - e. Relocates entire DRB to new page -- only does page relative move.

- f. Transfers control to relocated DRB to have it bring in Core Resident DOS-M System from Disc.

- C. Disc Resident Bootstrap (DRB) Listing Study [SLIDES 71A - 71F]
 1. Configures all Disc I/O instructions (within locations 15643-15724 octal) according to Data Channel already setup in location 15773 by supplied bootstrap.
 2. Calls PLOAD routine four times to load in the four sections of Core Resident System defined in ASPBF through ASPBF+11 (3 words per load). SLOAD reads a sector at a time. Note how DMA Control Word does not have to be output again here because it was already outputted by Supplied Bootstrap in loading DRB.
 3. Examine Equipment Table of CRS just loaded to accomplish the following:
 - a. For DVR05 - configure all I/O instructions in this System TTY driver.
 - b. For DVR31 - modify its EQT entry for "RUN TIME DISC" channels. Configure all I/O instructions in this driver. Configure DMA control word in this driver. Set + and - # sectors per track locations in this driver.
 4. Set RUN TIME DISC channel in DISCO (base page location 154B; bits 15-11).
 5. Set RUN TIME DISC Interrupt Table entries in correct interrupt table entry and also put correct entry in interrupt table where Generator Disc Channel entries were.
 6. Set new I/O channels in Equipment Table for devices swapped with RUN TIME DISC.
 7. Set RUN TIME SYSTEM Subchannel in Base Page location 155 octal from information passed by Supplied Bootstrap.
 8. Set User Label TRACK/SECTOR Disc Address (Base Page location 200 octal) according to Base Page locations 155 and 175 octal.
 9. Set Next TRACK/SECTOR Address on Current User Disc (Base Page Location 157 octal).
 10. Set Current User Disc Subchannel # (location 161) equal to Default User Disc Subchannel # (location 175).
 11. Branch to location 3 indirect to start DOS-M System.

D. DOS-M System Halts [SLIDE 72]

These Halts are only during System Operation following successful bootstrap.

E. DOS-M I/O Request Processing Example

1. Materials used

- a. Tape Recording of step by step execution
- b. Large chart of DOS-M I/O Request Processing
- c. Foldout flowcharts on DOS-M (next section)
- d. Slides
 - (1) Equipment Table Format; # 10B
 - (2) Device Reference Table Format; # 10C
 - (3) Interrupt Table Format; # 10D

2. Procedure

- a. Using the above tape recording and materials, trace an example I/O Request Operation (b below) through all major steps that occur from the initial EXEC call until the I/O operation is complete.
- b. The example I/O operation will be:

JSB EXEC	(Call to Executive Supervisor)
DEF RTN	(Define Return Address)
DEF RCODE	(Define Request Code Address)
DEF CONWD	(Define Control Word Address)
DEF BUFA	(Define Buffer Start Address)
DEF BUFL	(Define Buffer Length Address)
RTN (Return Point)	
⋮	
RCODE DEC 1	(Read Operation R.C.)
CONWD OCT 5	(Logical Unit 5)
BUFA BSS 36	(36 word or 72 char. Buffer)
BUFL DEC -72	(72 character length)

DOS-M FLOWCHARTS TABLE OF CONTENTS

DISC MONITOR

<u>Name/Entry Label(s)</u>	<u>Page(s)</u>
✓\$CIC	1
\$IOCM,\$IORQ	2
EXEC	3
\$WAIT,\$BLOP,\$MBSY,\$DMA,\$EBSY	4
\$TYPE	5
\$SYIO,DRIVR,NRPAR	6
\$TEST	7
\$JLOD,\$MDLD,IO.4Ø	8
\$LDVR,DISCX,\$GDTK,\$DISC,\$LDEX,\$STRT	9
\$IDLI,\$CLER	10
ADCHK,LUCHK,\$EFAD,RQEQT,SETEQ	11
\$DMAX,RCHAN,\$MOVE	12
ERRTN MPERR,RQERR,CLERR,IERR	13
DERR,ILINP,ERRØ1,ERRØ2,ERRØ3	13
ERRØ4,ERRØ5,ERRØ6	13

EXECUTIVE MODULES

\$EXØ1	14
\$EXØ2	15
\$EXØ3,\$EXØ6	16
\$EXØ4	17
\$EXØ5	18
\$EXØ7,\$EXØ8	19
(Reserved for \$EXØ9)	20
\$EX1Ø	21
(Reserved for \$EX11)	22
\$EX12	23
\$EX13	24
\$EX14	25
\$EX15	26
\$EX16	27

EXECUTIVE MODULES (continued)

<u>Name/Entry Label(s)</u>	<u>Page(s)</u>
(Reserved for \$EX17)	28
\$EX18	29A, 29B, 29C
\$EX19	30
(Reserved for \$EX20)	31

SYSTEM SUBROUTINES

ASCII	32
(Reserved for DUMRX)	33
(Reserved for \$LBL)	34
(Reserved for \$SRCH)	35
(Reserved for \$ADDR)	36

DRIVERS

DVR01	37
-------	----

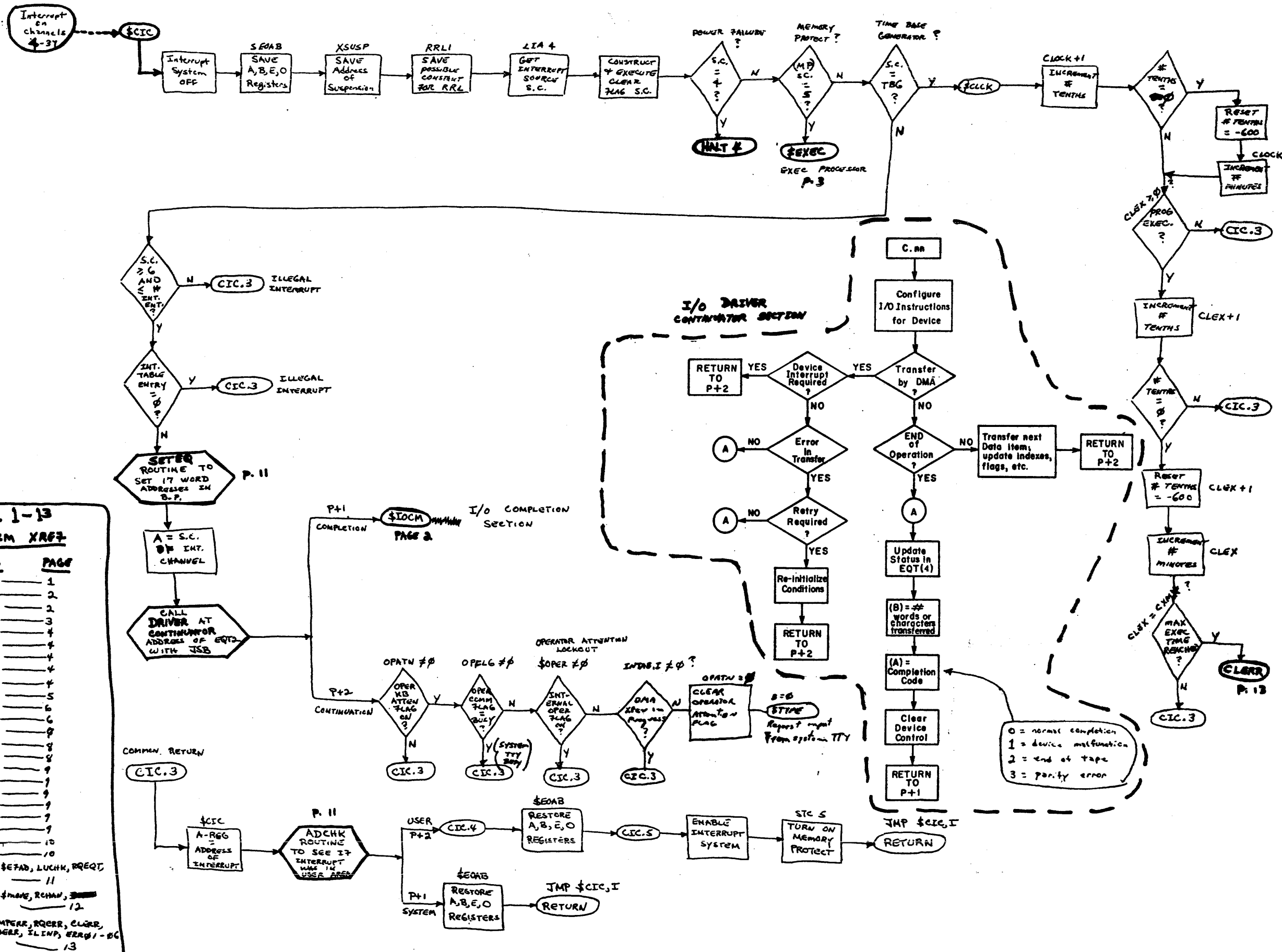

P. 1-13
DISCM XREF

LABEL	PAGE
\$CIC	1
\$IOCM	2
\$IOREQ	2
EXEC	3
\$WAIT	4
\$STOP	4
\$MBSY	4
\$DMA	4
\$DBSY	4
\$TYPE	5
\$YIO	6
DRVR	6
\$TEST	8
\$JLDB	8
\$MDLB	8
\$IDVR	9
\$DSCX	9
\$GTHK	9
\$DESC	9
\$LDEX	7
\$SRAT	7
\$LRI	10
\$CLR	10
ADCHK, \$FAD, LUCHK, REQI, SETEQ	11
\$DMAX, \$MARE, RCHM, \$	12
ERRM, MPEAK, RQERR, CLERR, ERR, DELE, ILINP, ERR01-06	13

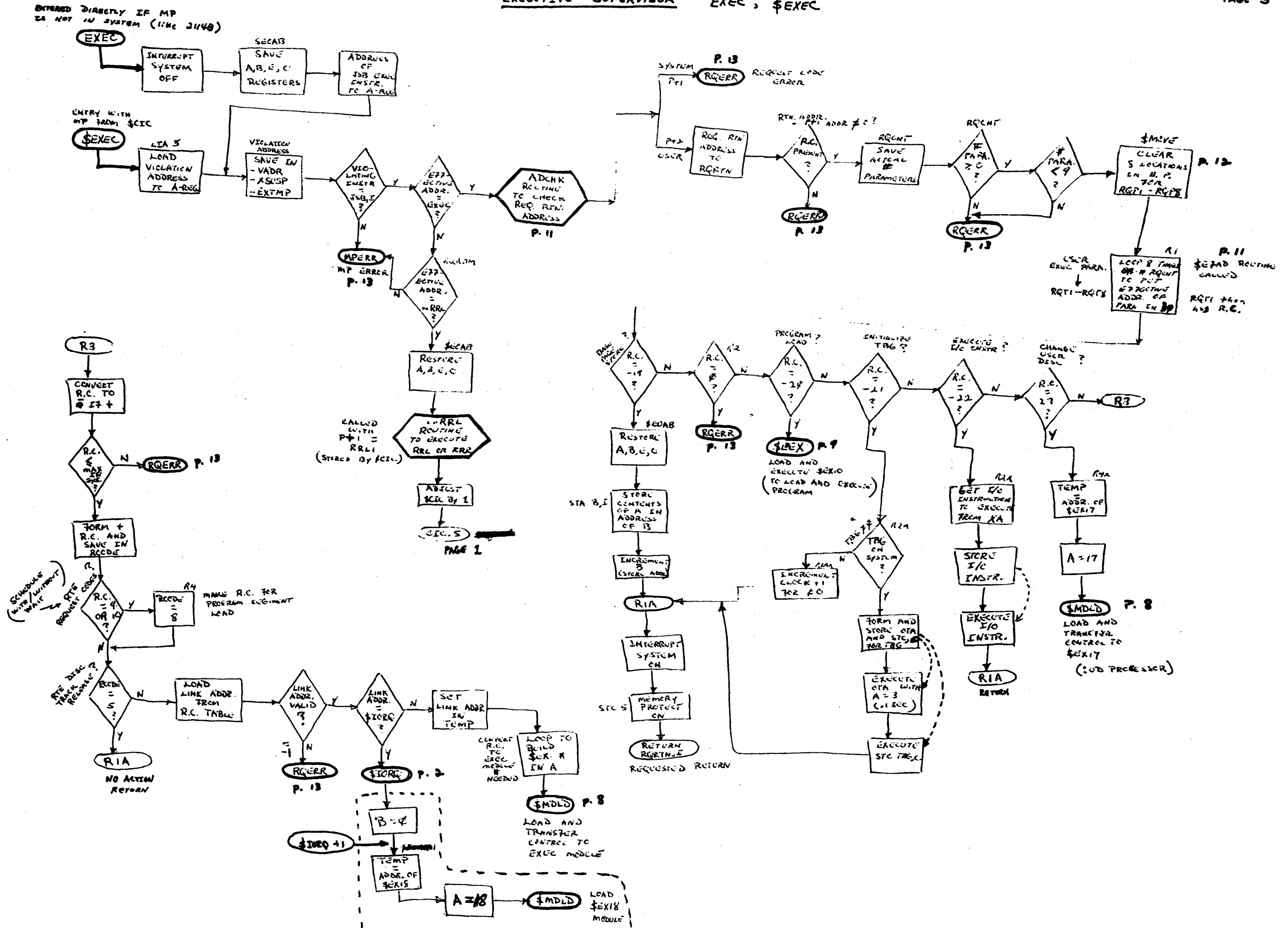

System Edits
 - Busy I/O Chan
 - I/O Device Module busy
 - DMA busy
 - Exec Mod Area busy
 - Idle Loop

$\$WAIT$, $\$BLOP$, $\$MBSY$, $\$DMA$, $\$EBSY$

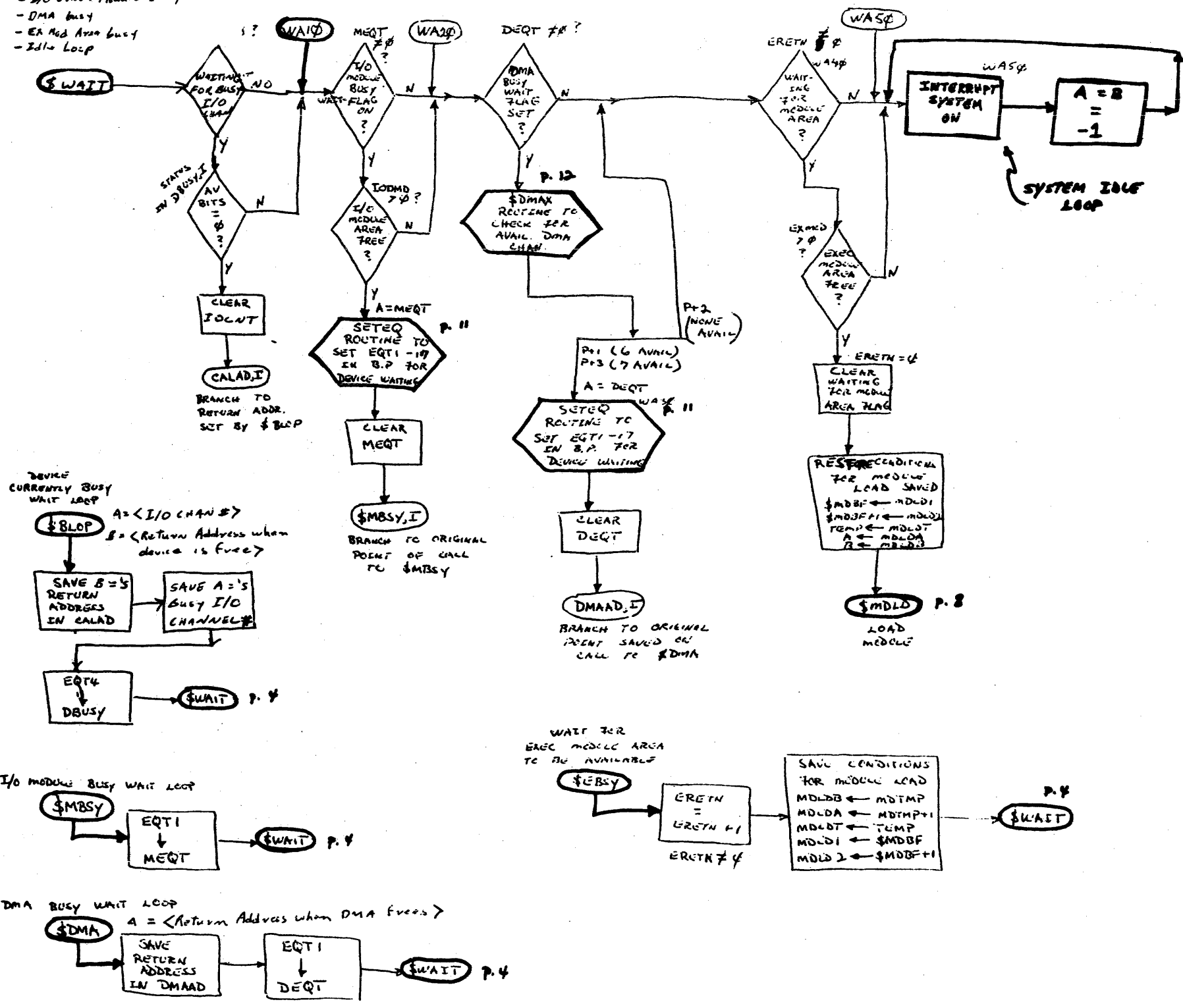

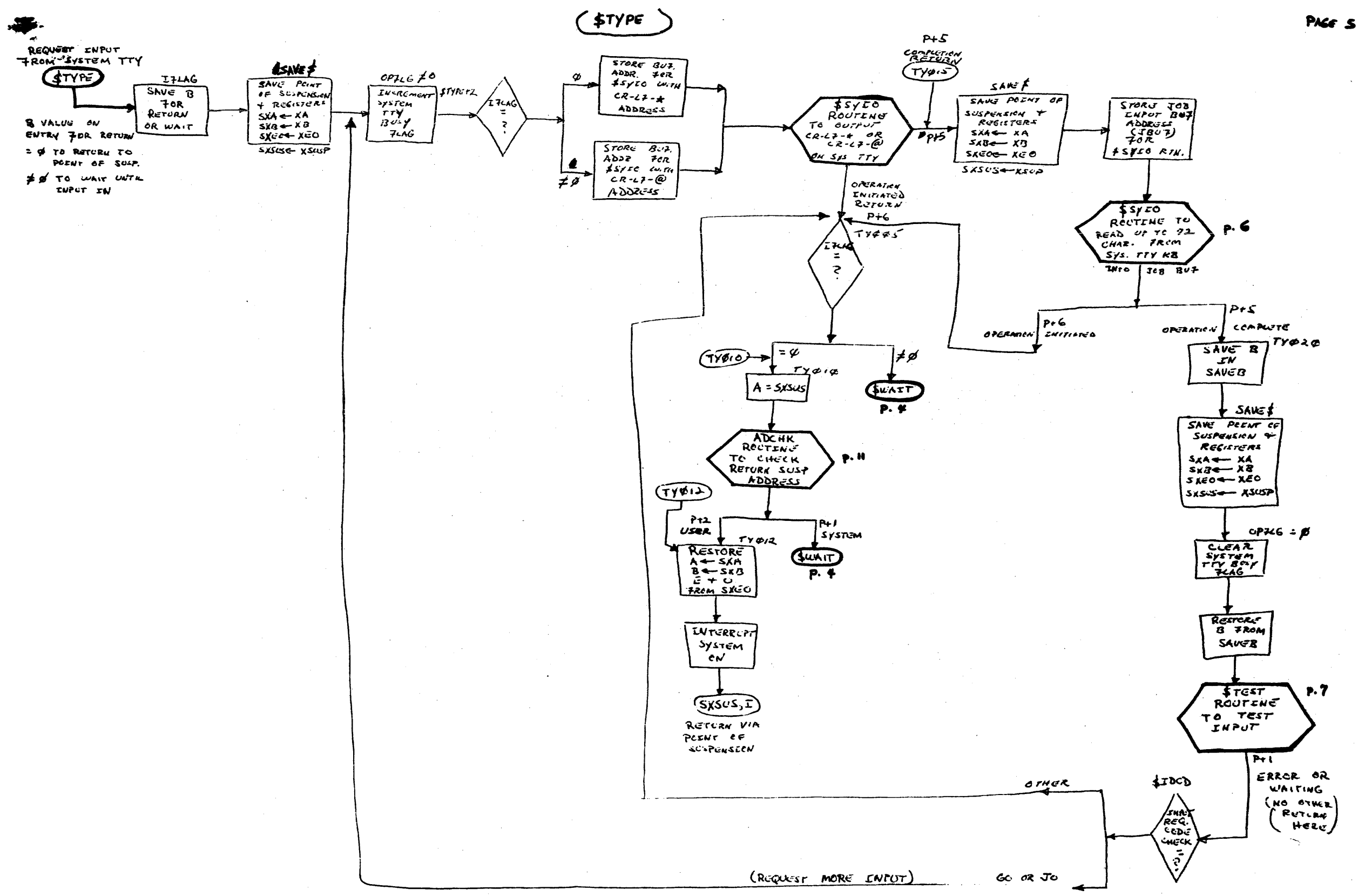

\$SYIO, DRVR

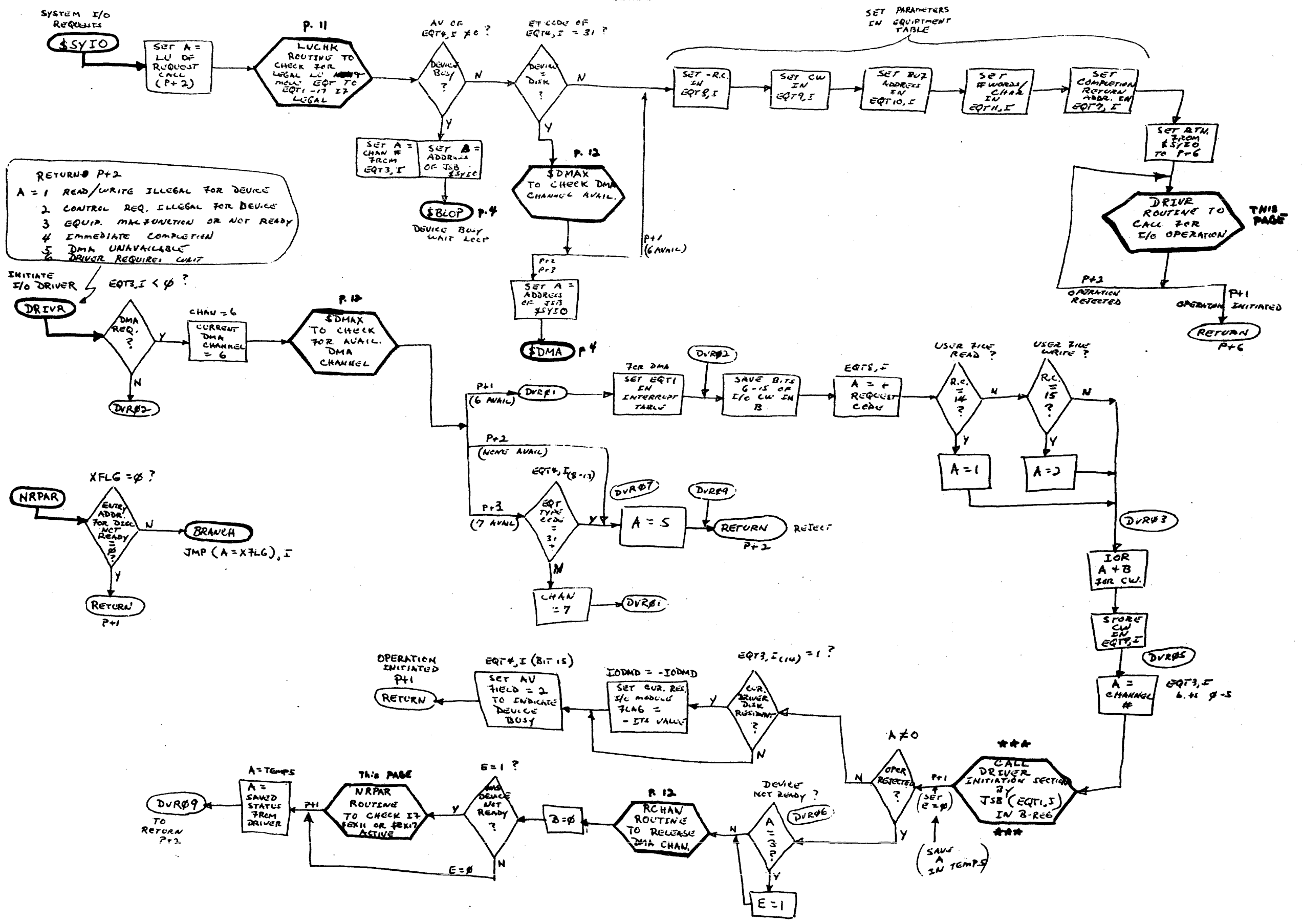

\$TEST

ENTRY: B = # WORDS INPUT
TO TEST IF DESIRED
INPUT HAS BEEN
INPUT

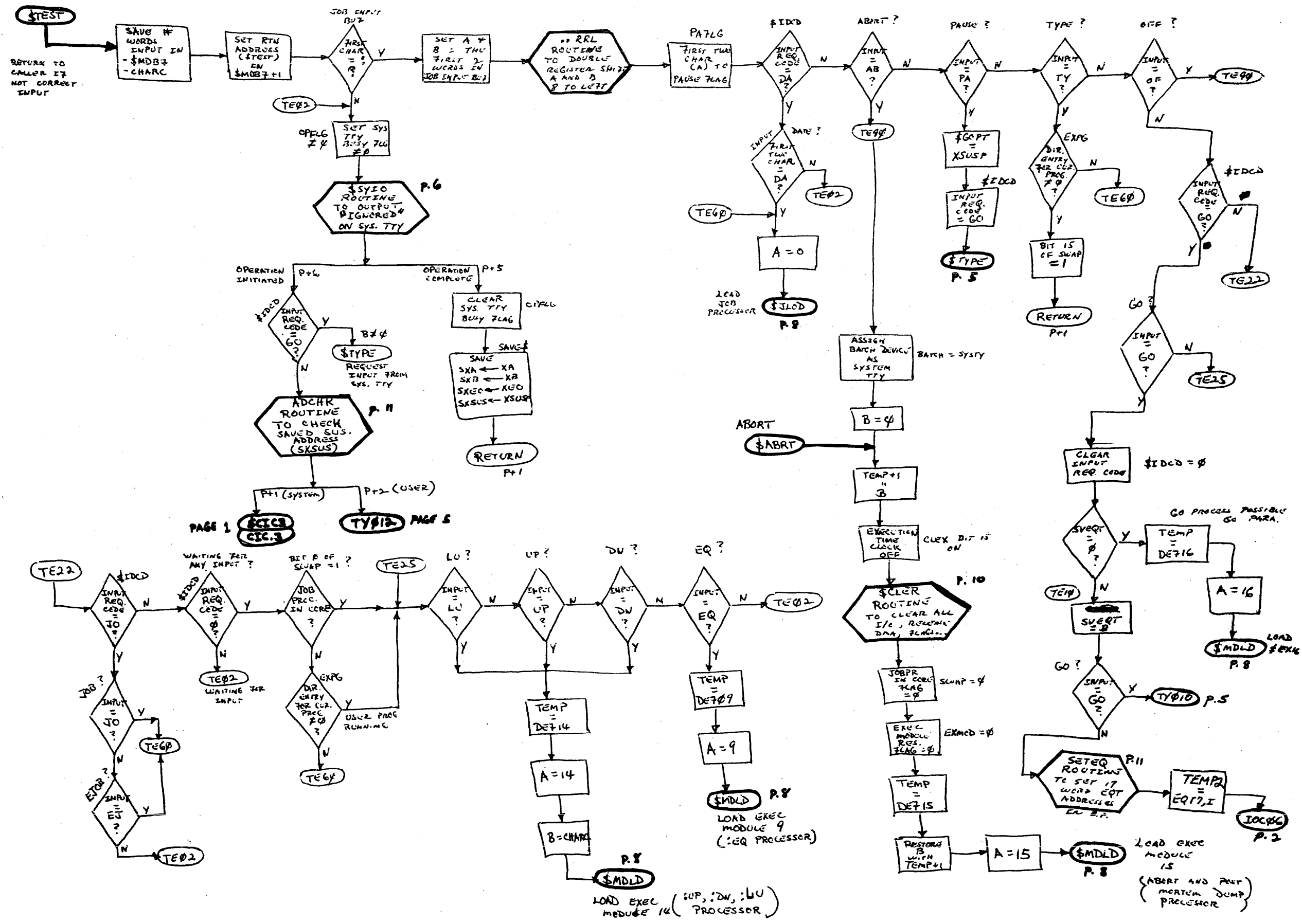

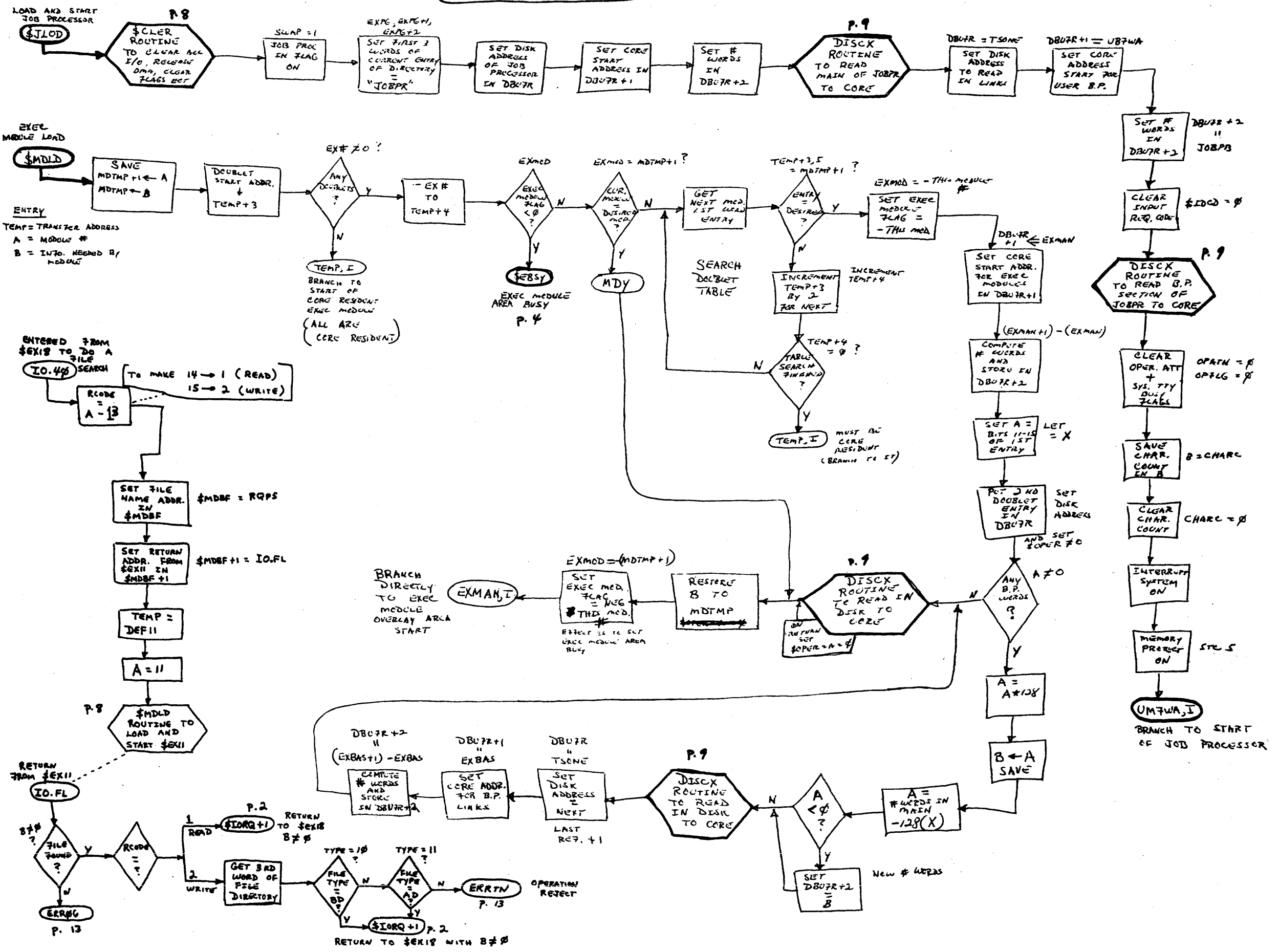

\$LDVR, DISCK, \$GDTK, \$DISC \$LDEX, \$STRT

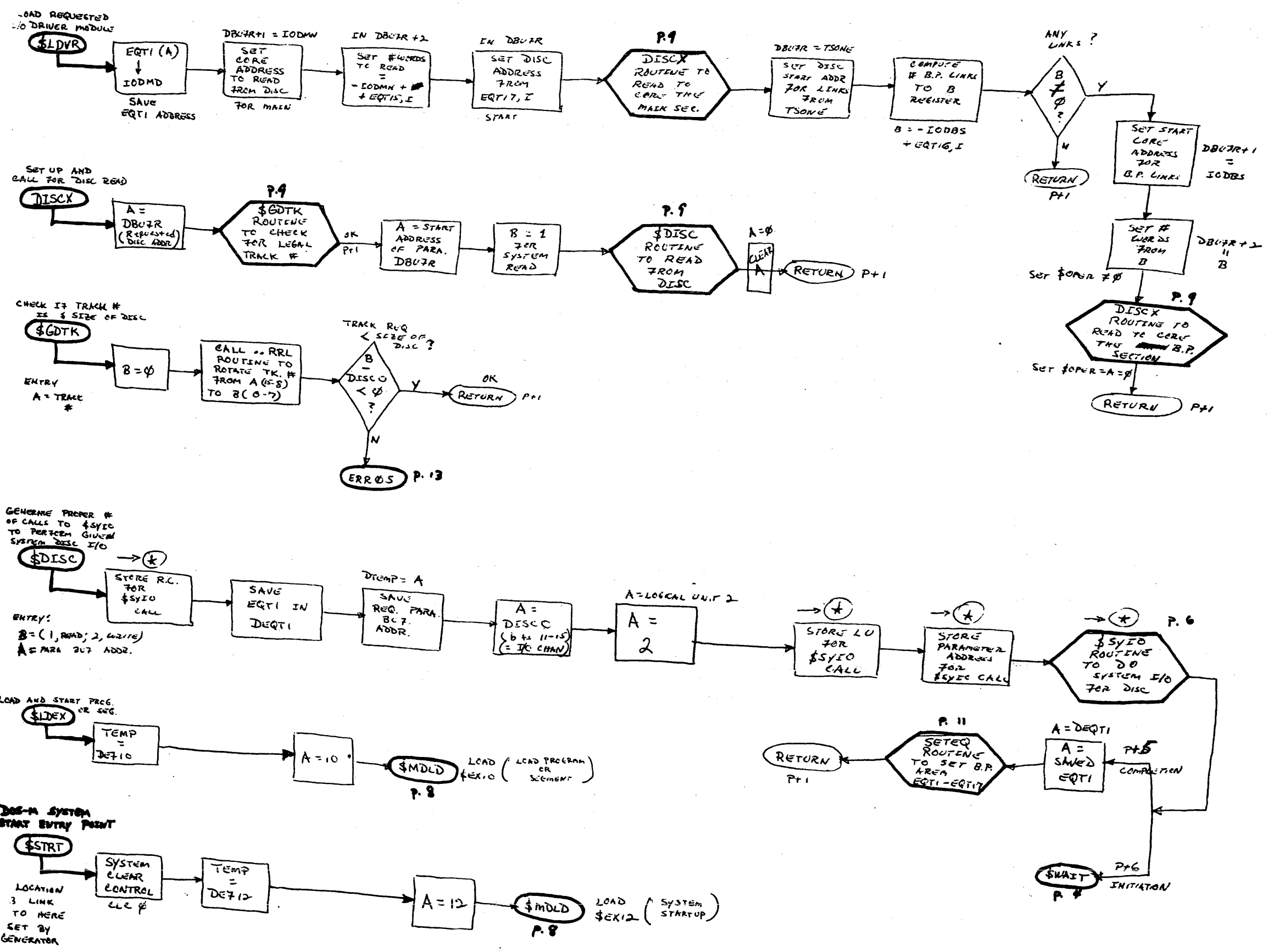

\$IDL1, \$CLER

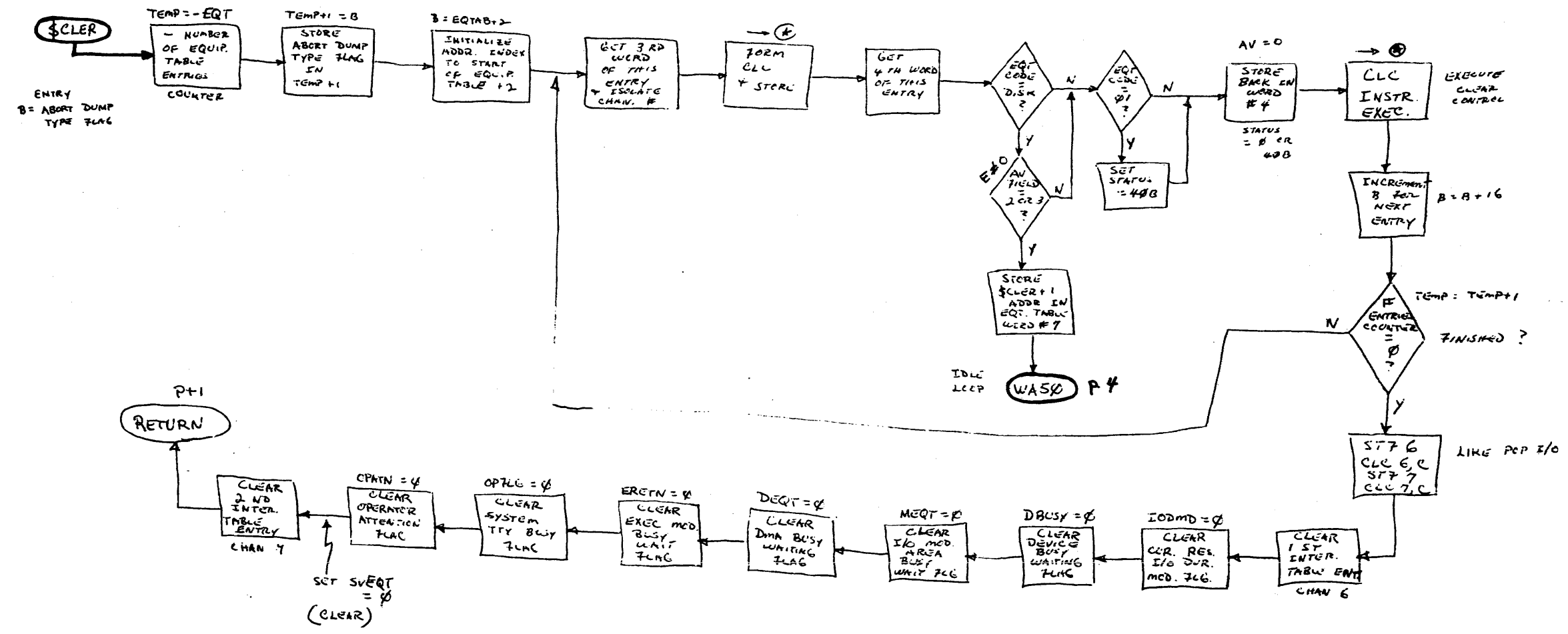
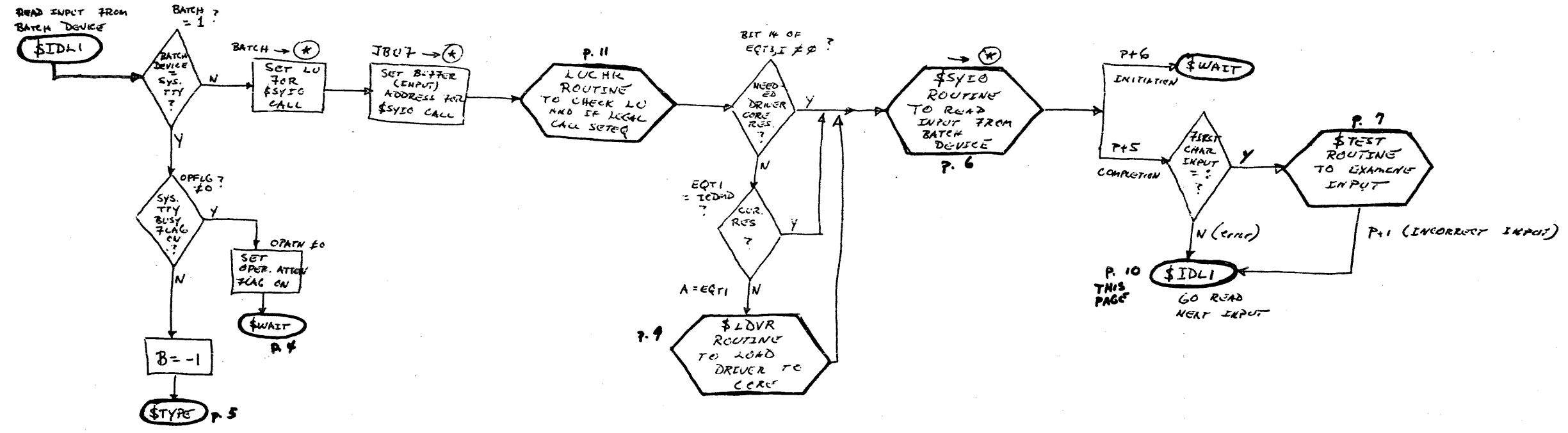

UTILITY SUBROUTINES

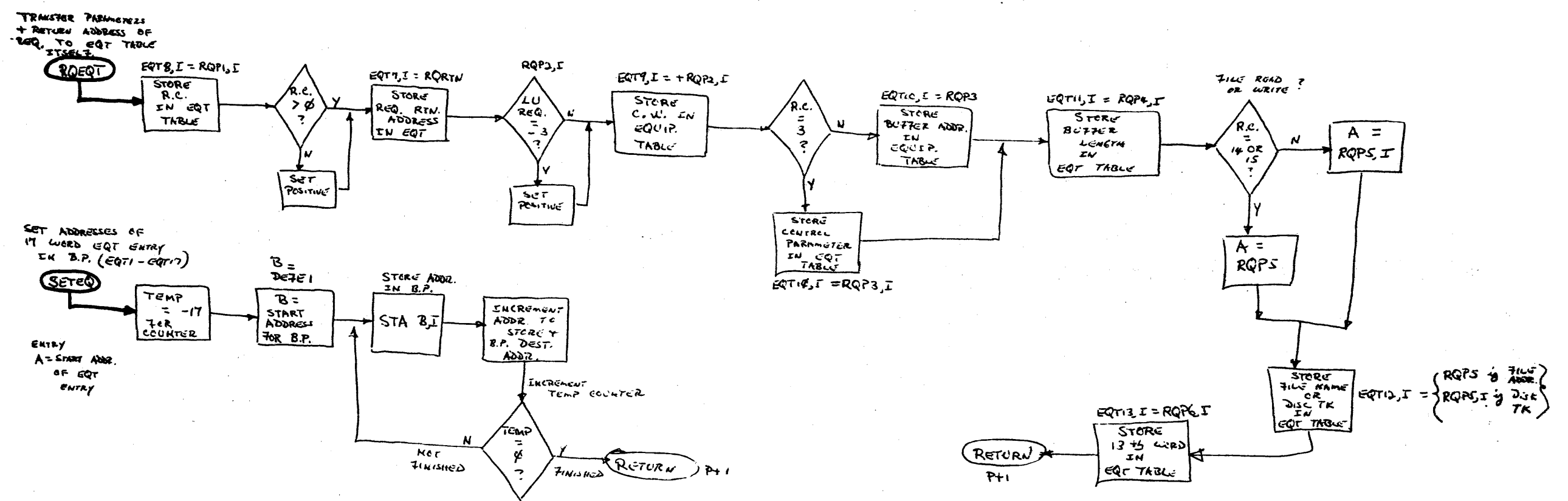
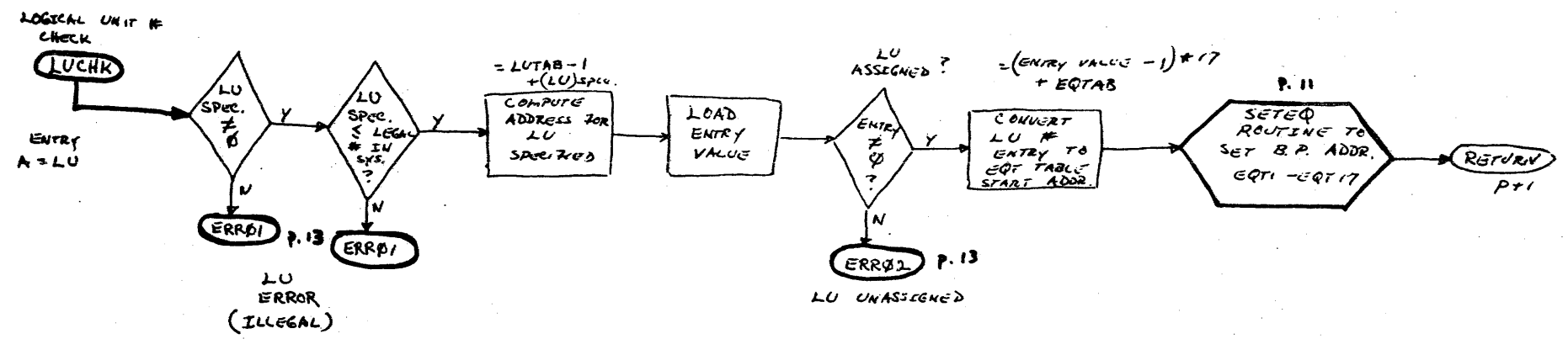
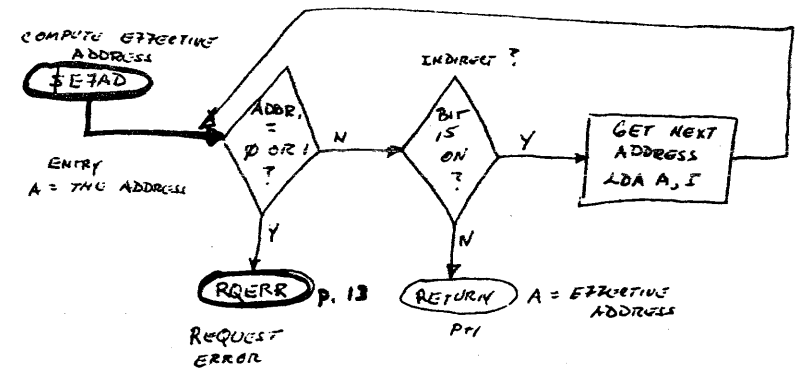
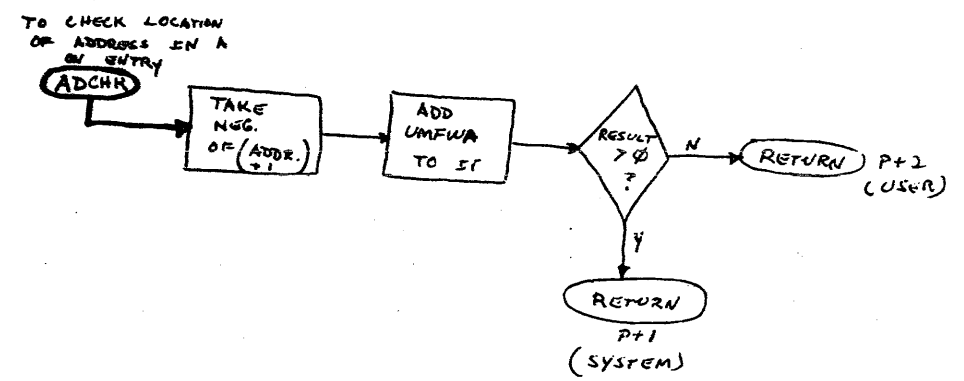

UTILITY SUBROUTINES

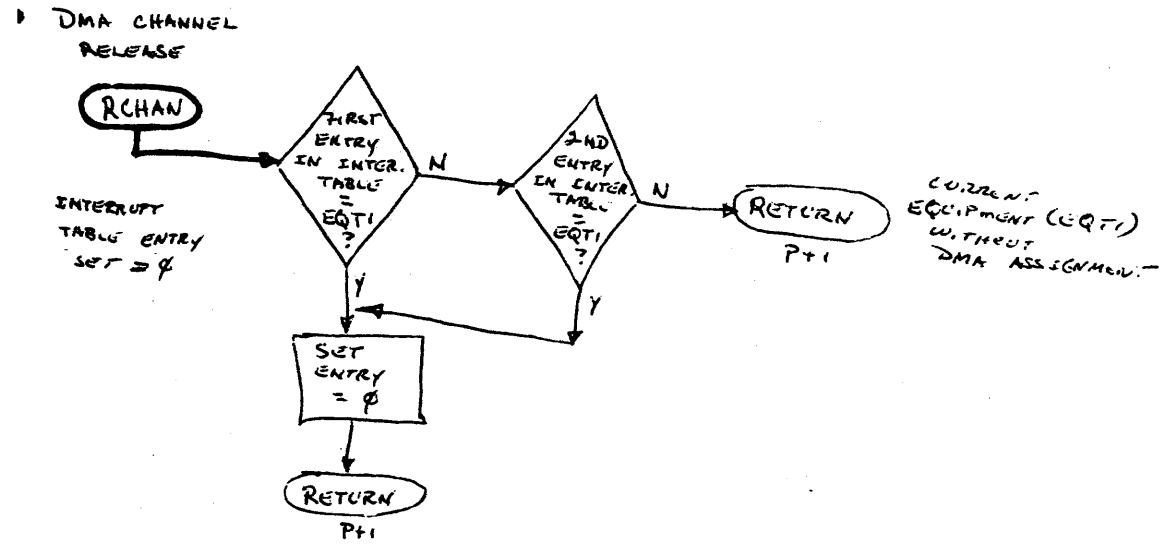
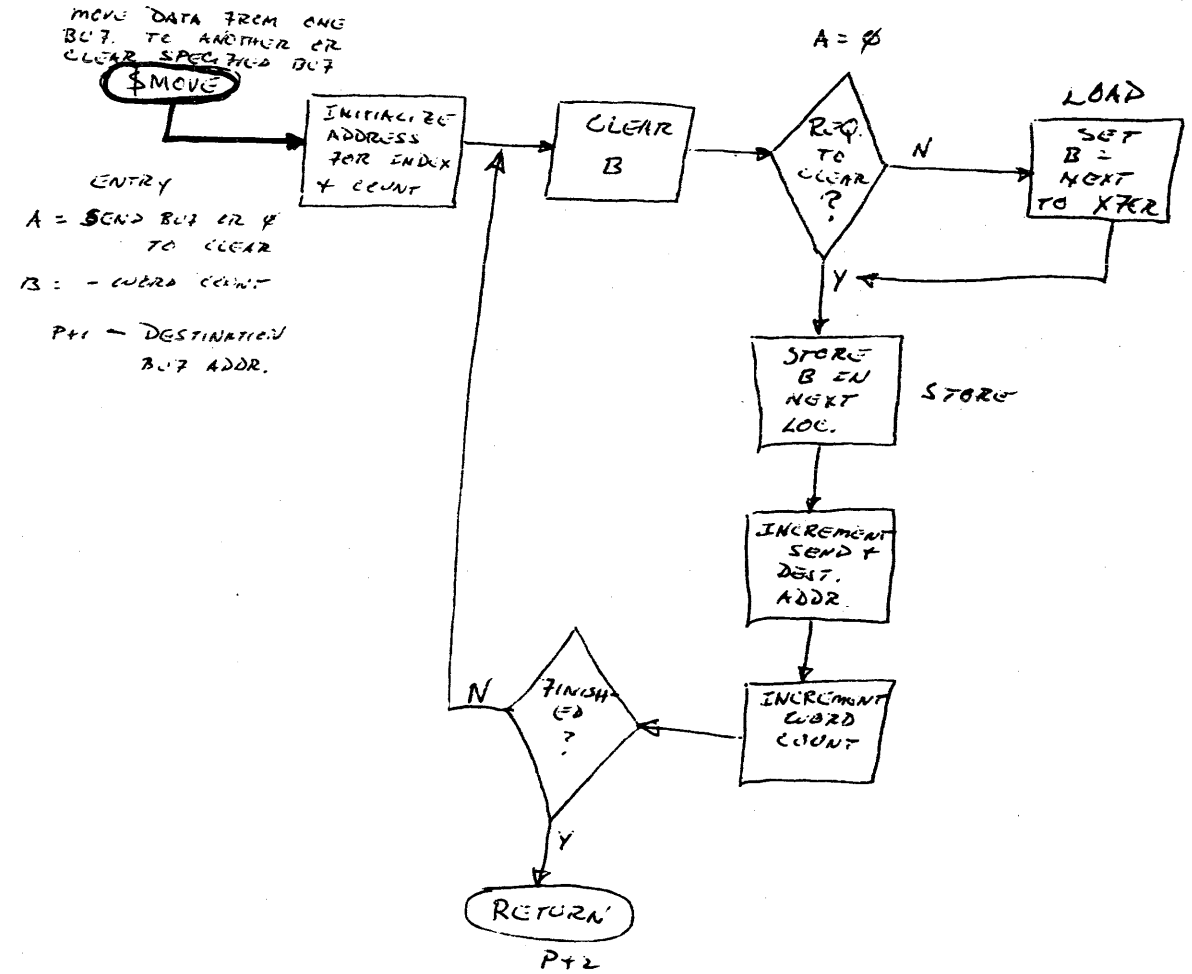
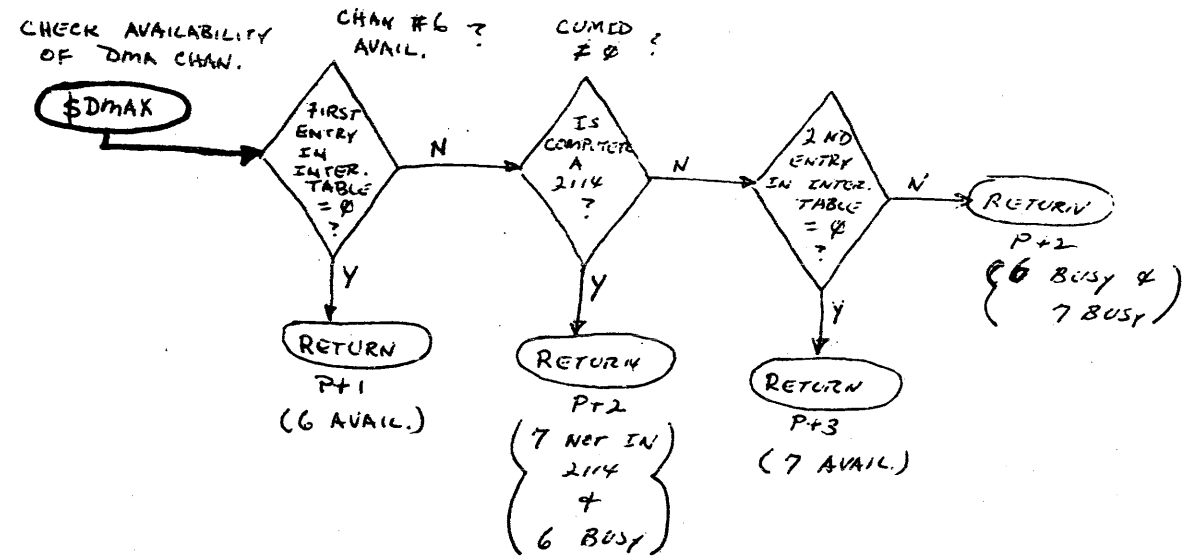

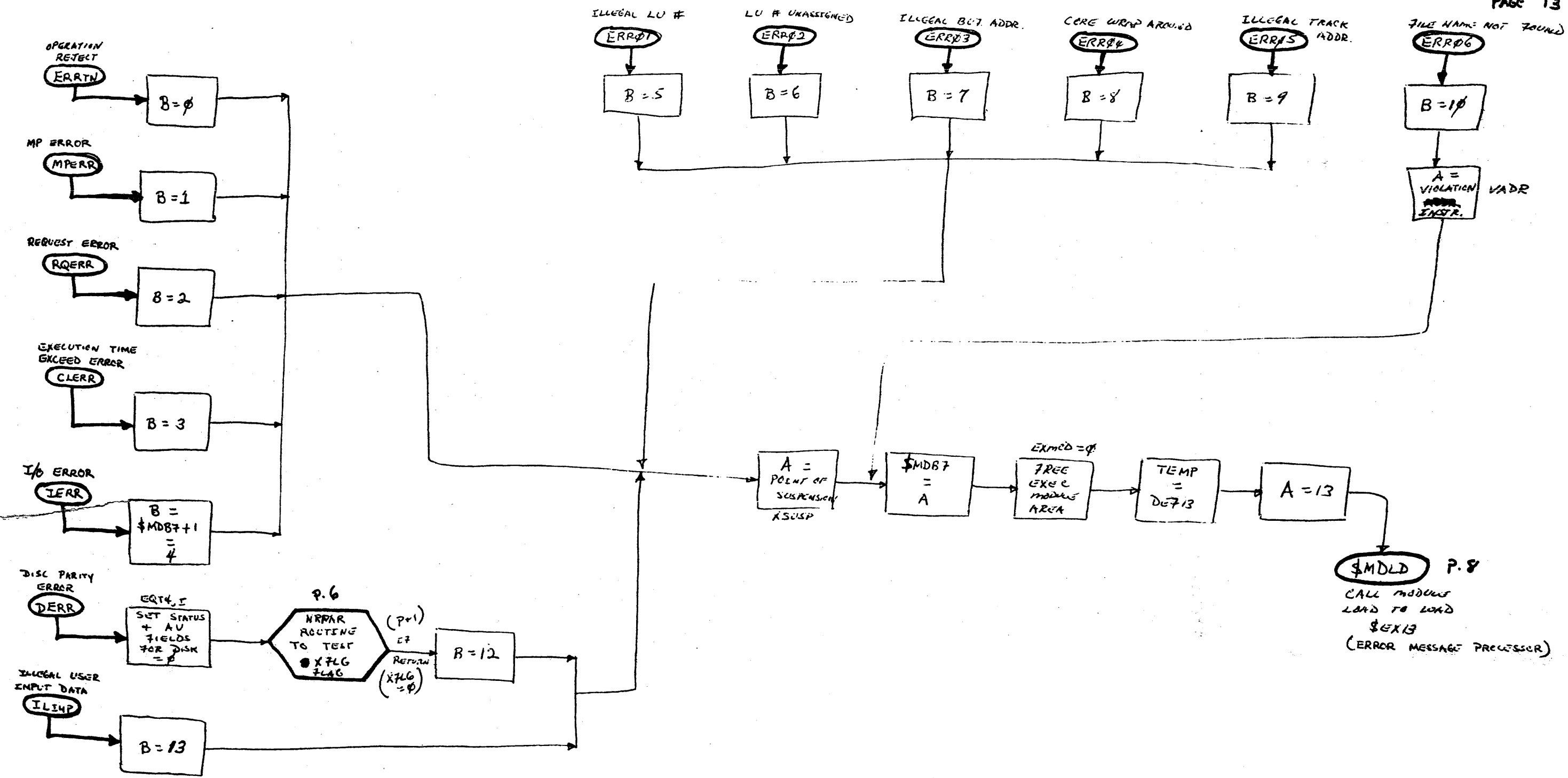

ERROR ENTRY POINTS

\$EX01 (DISC TRACK STATUS)

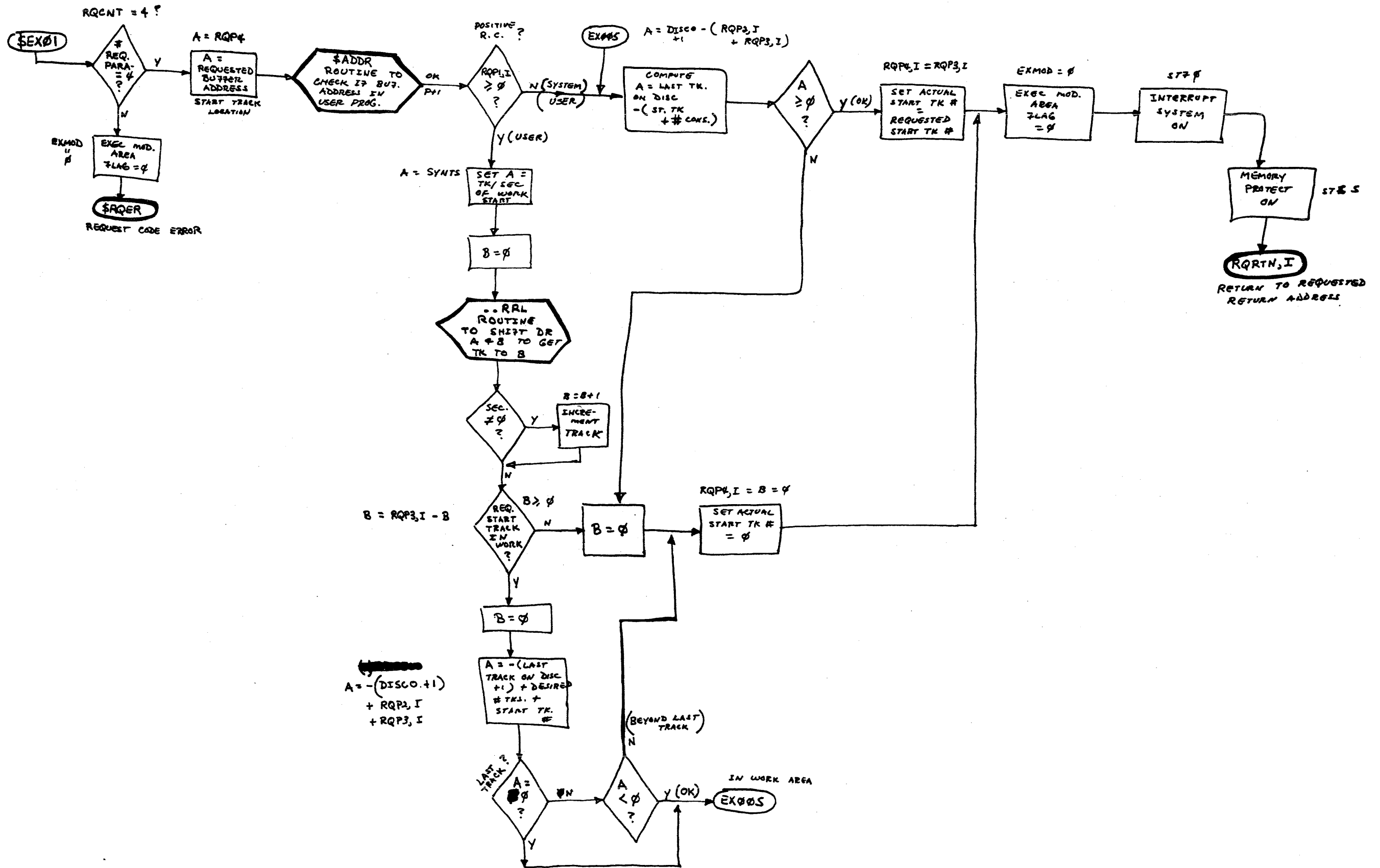

\$EX02 (DISC WORK TRACK LIMITS)

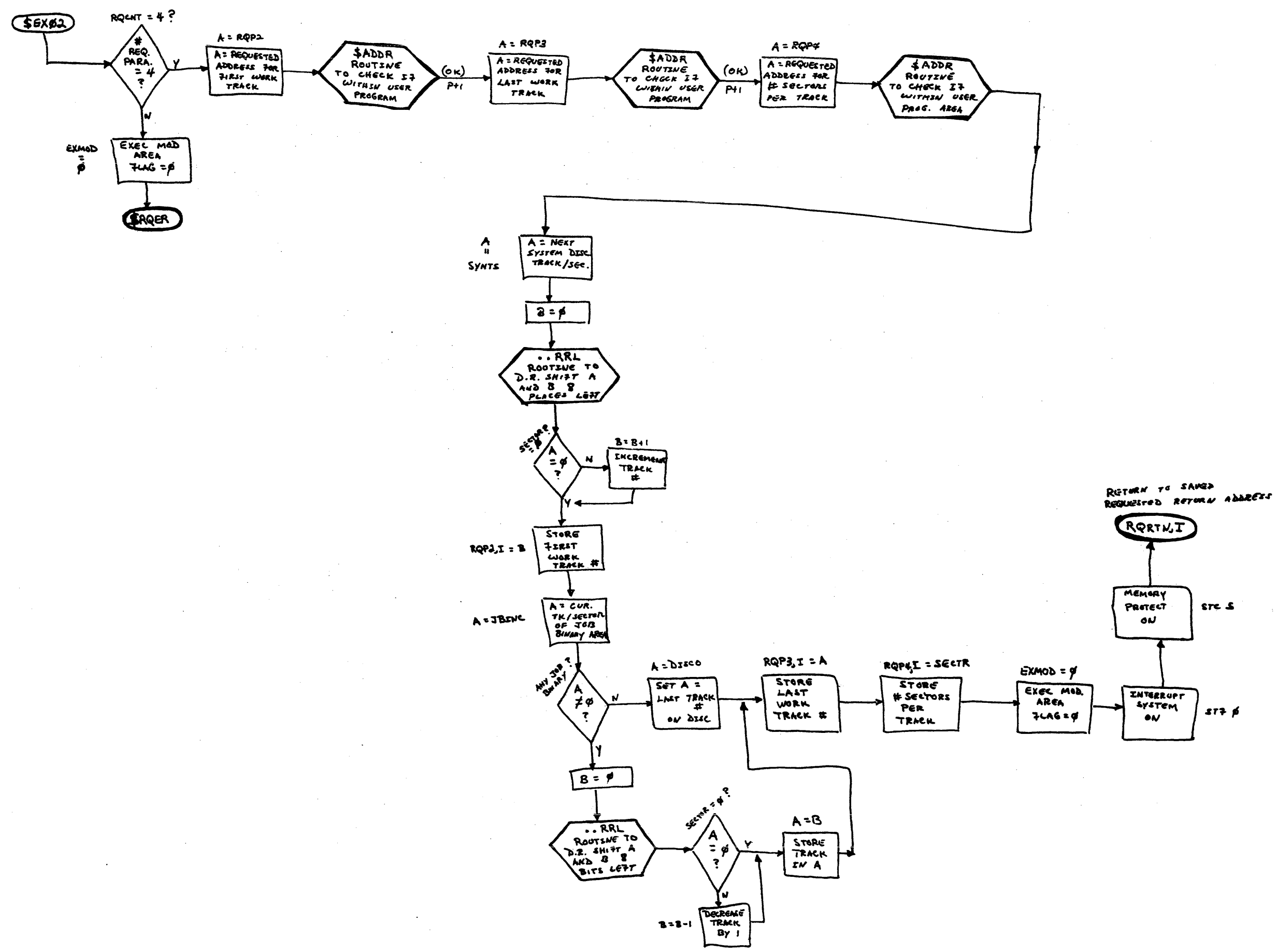

\$EX03 (PROGRAM COMPLETION)

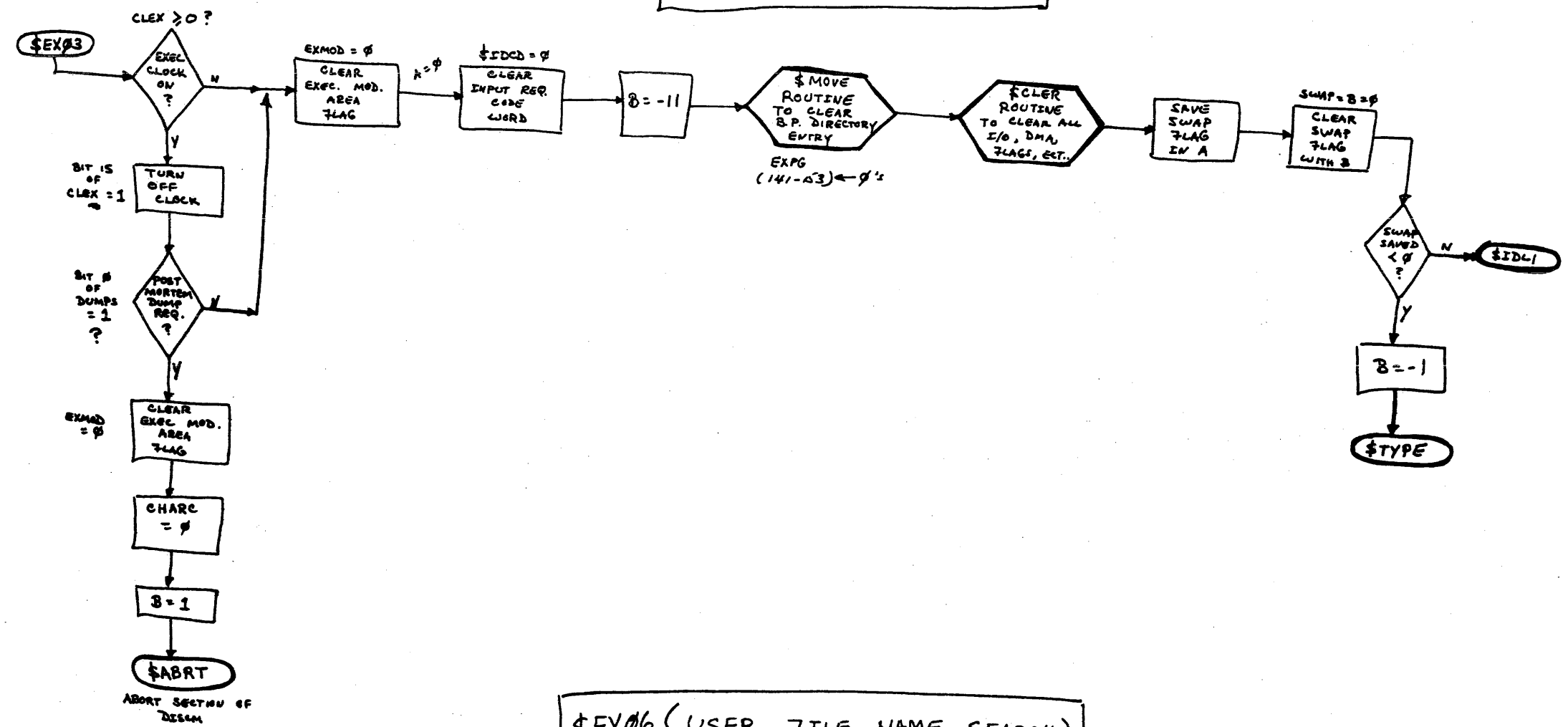

\$EX06 (USER FILE NAME SEARCH)

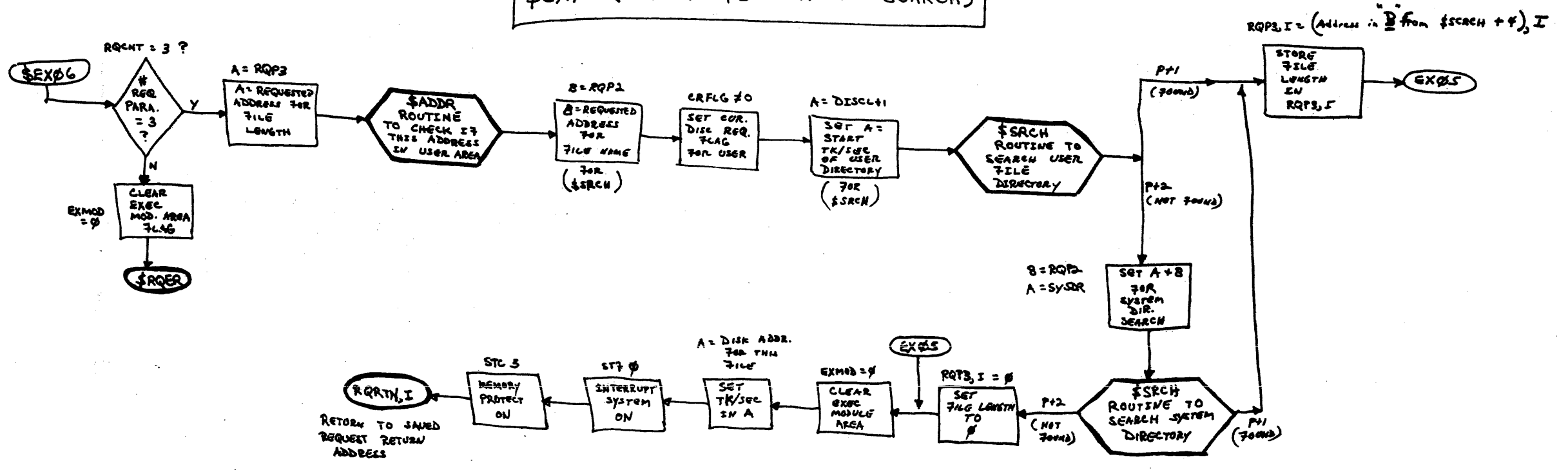

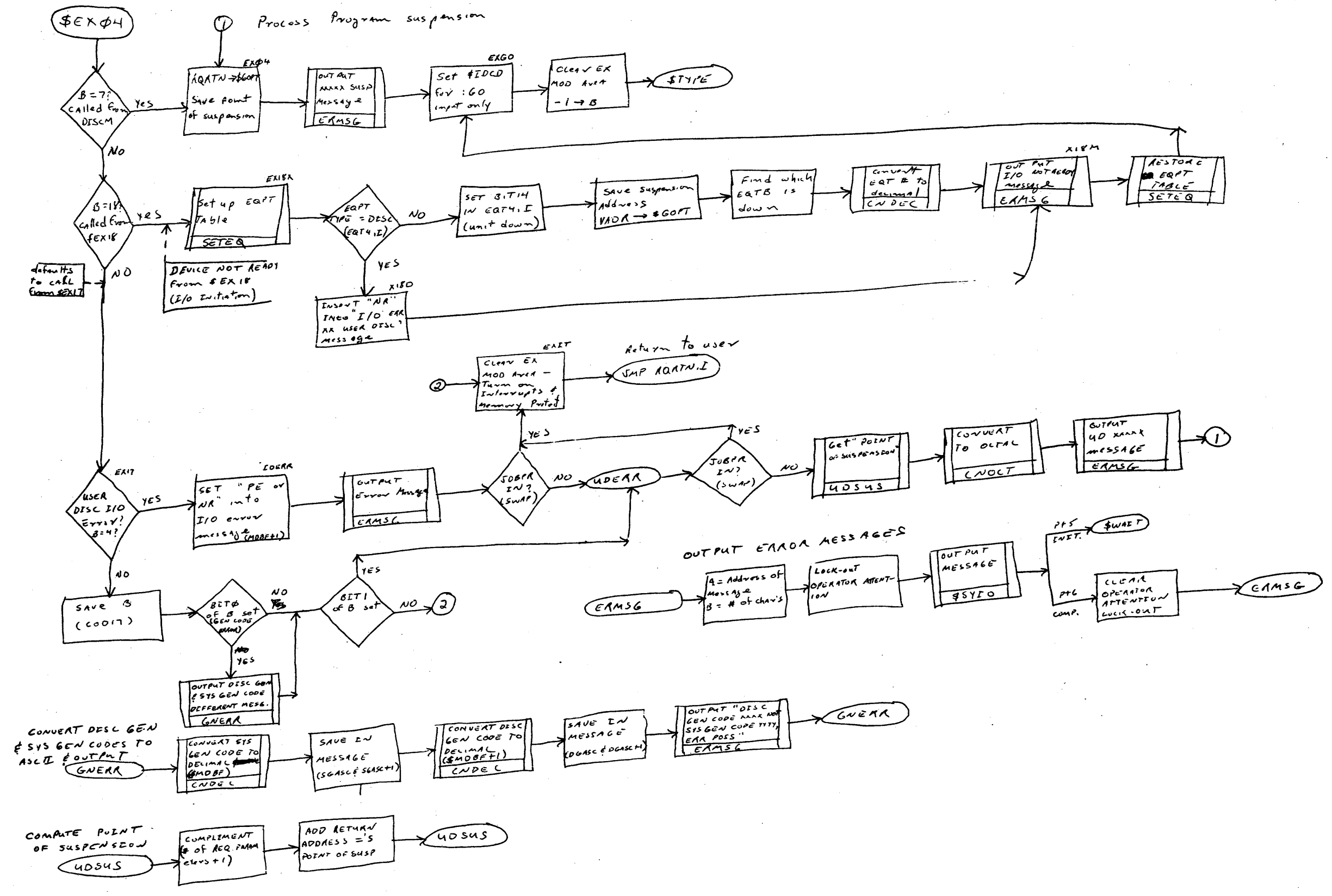

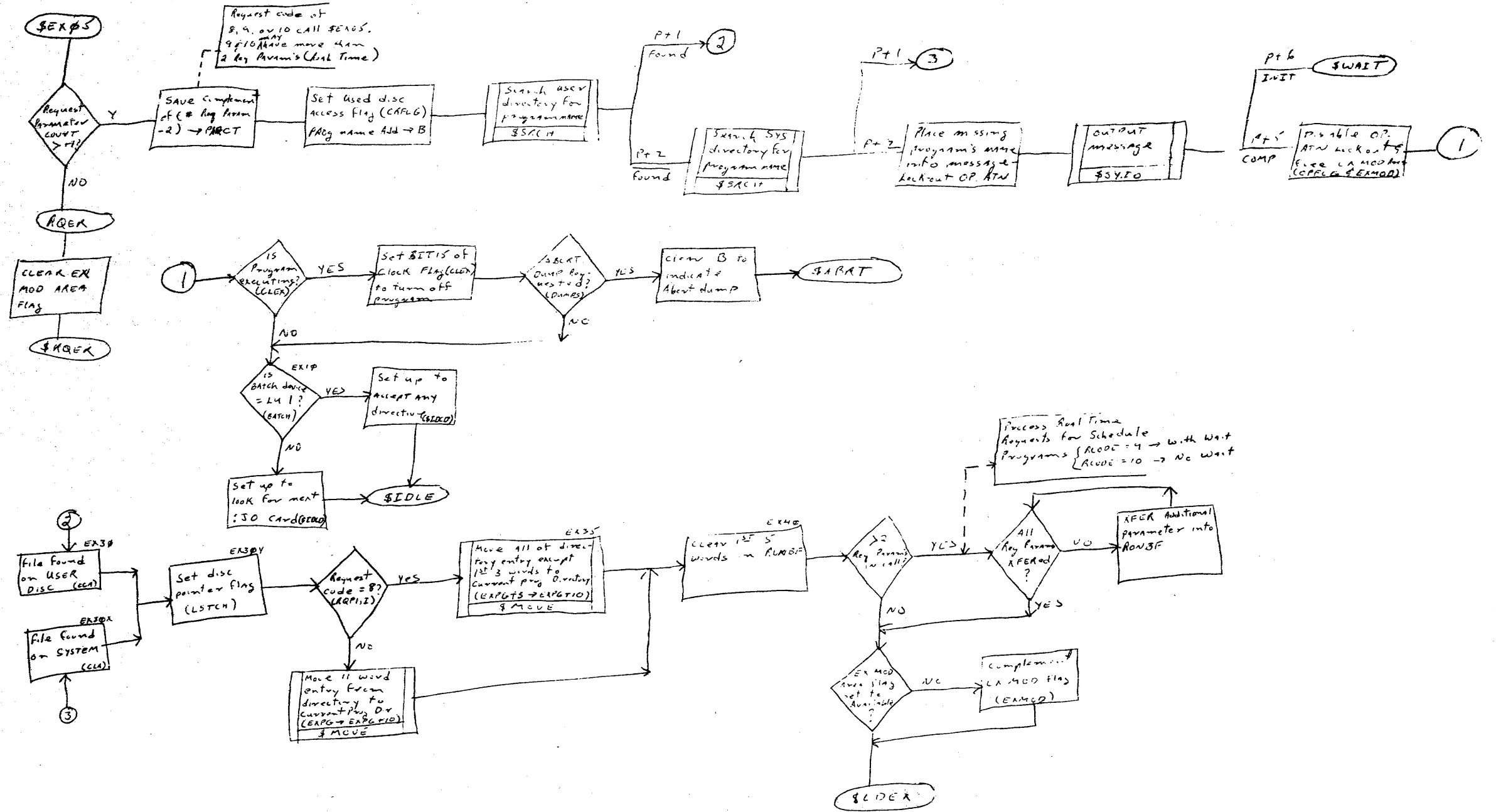

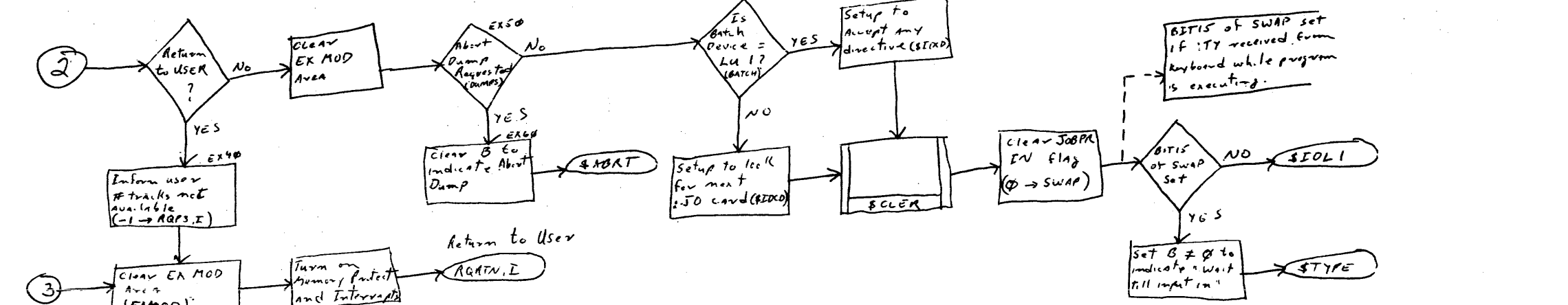
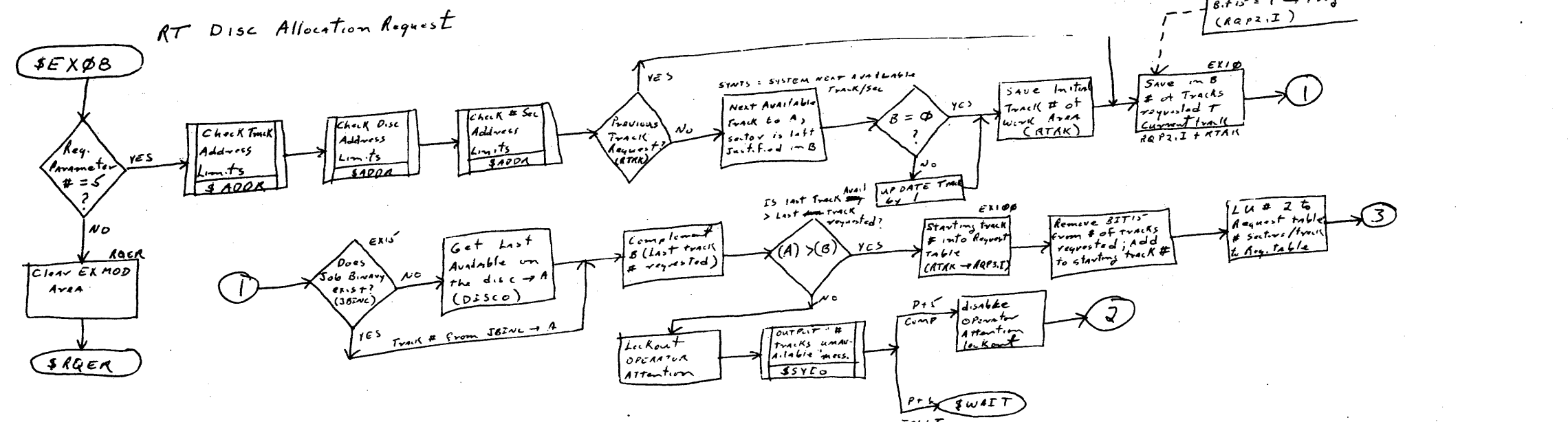
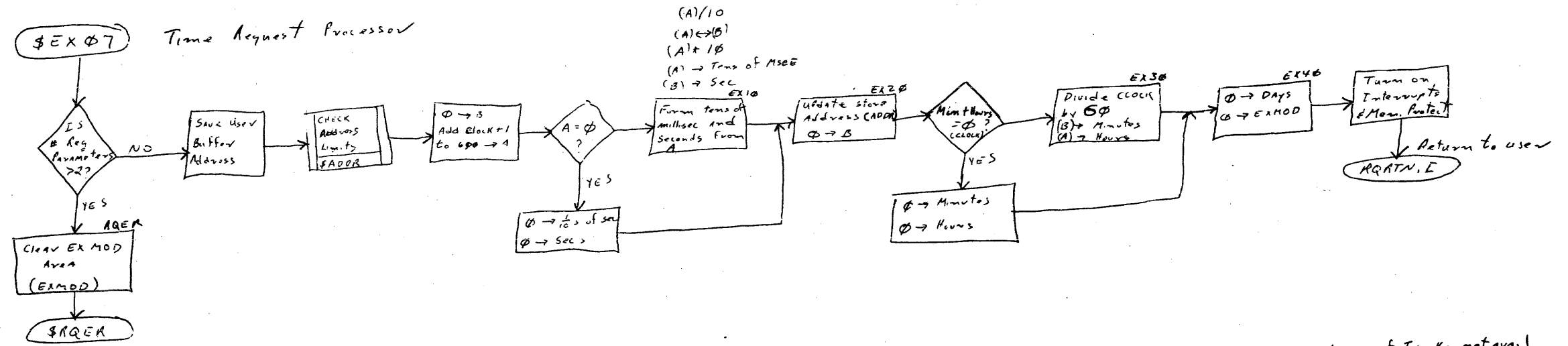

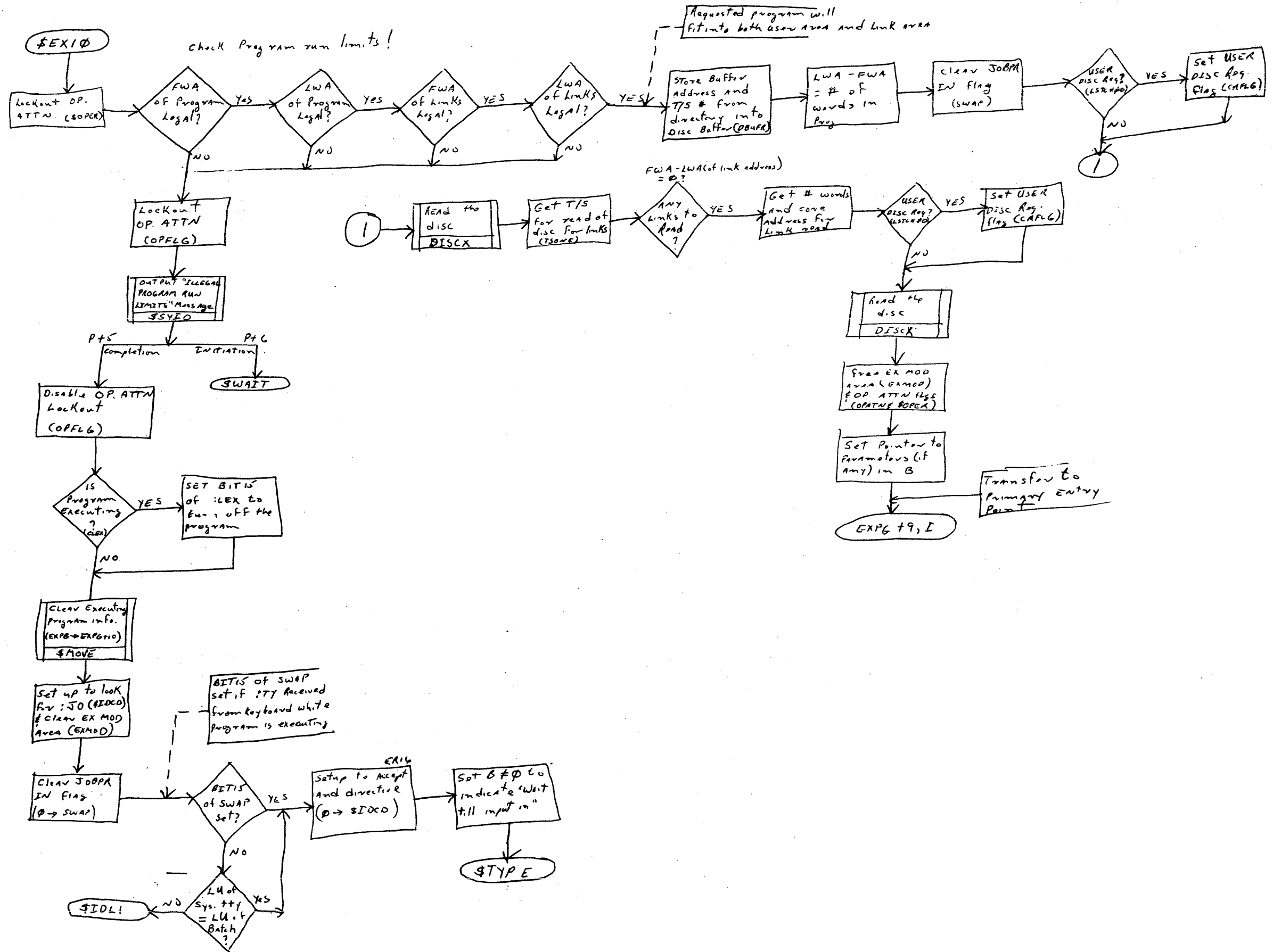

\$EX12 (SYSTEM STARTUP)

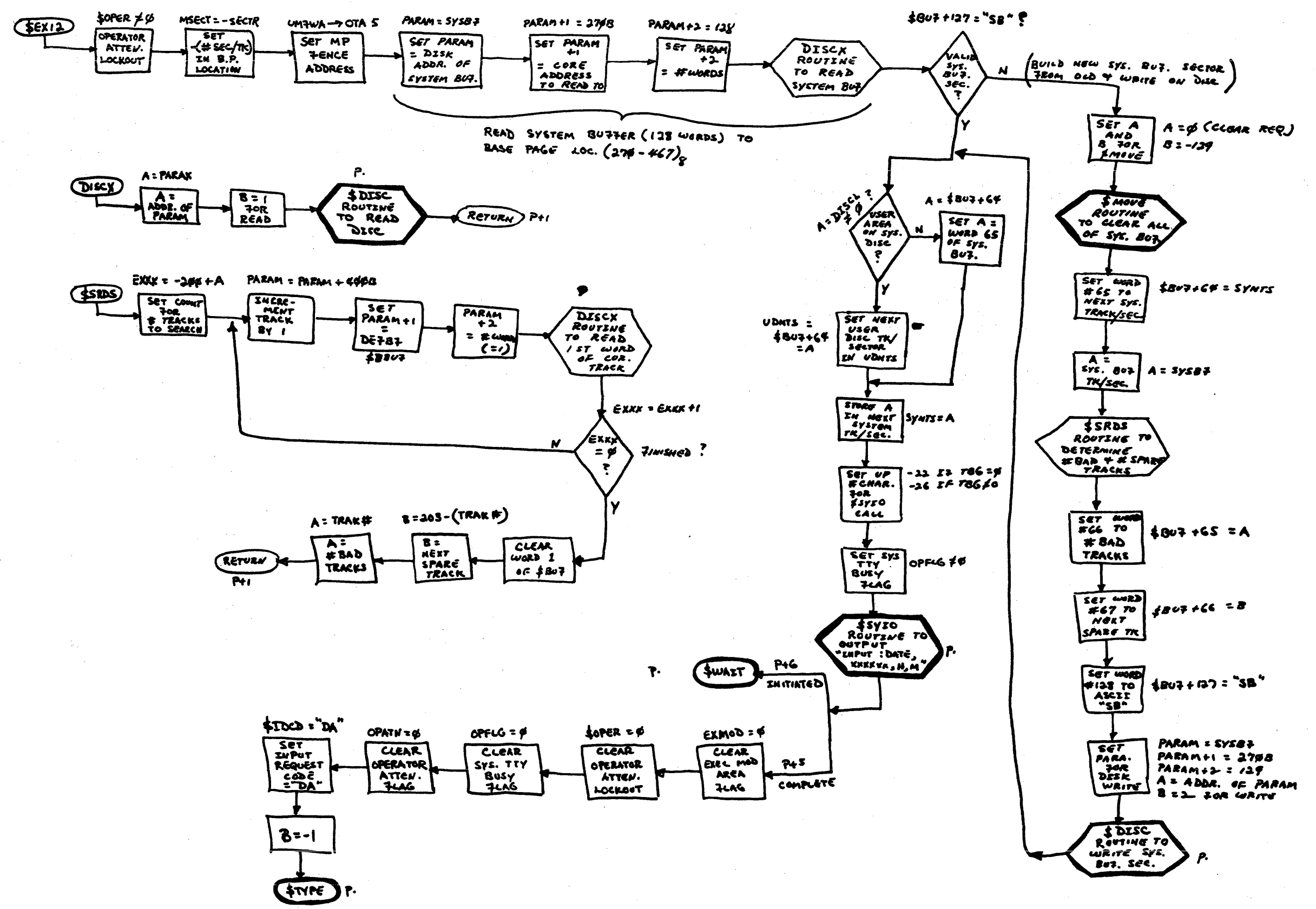

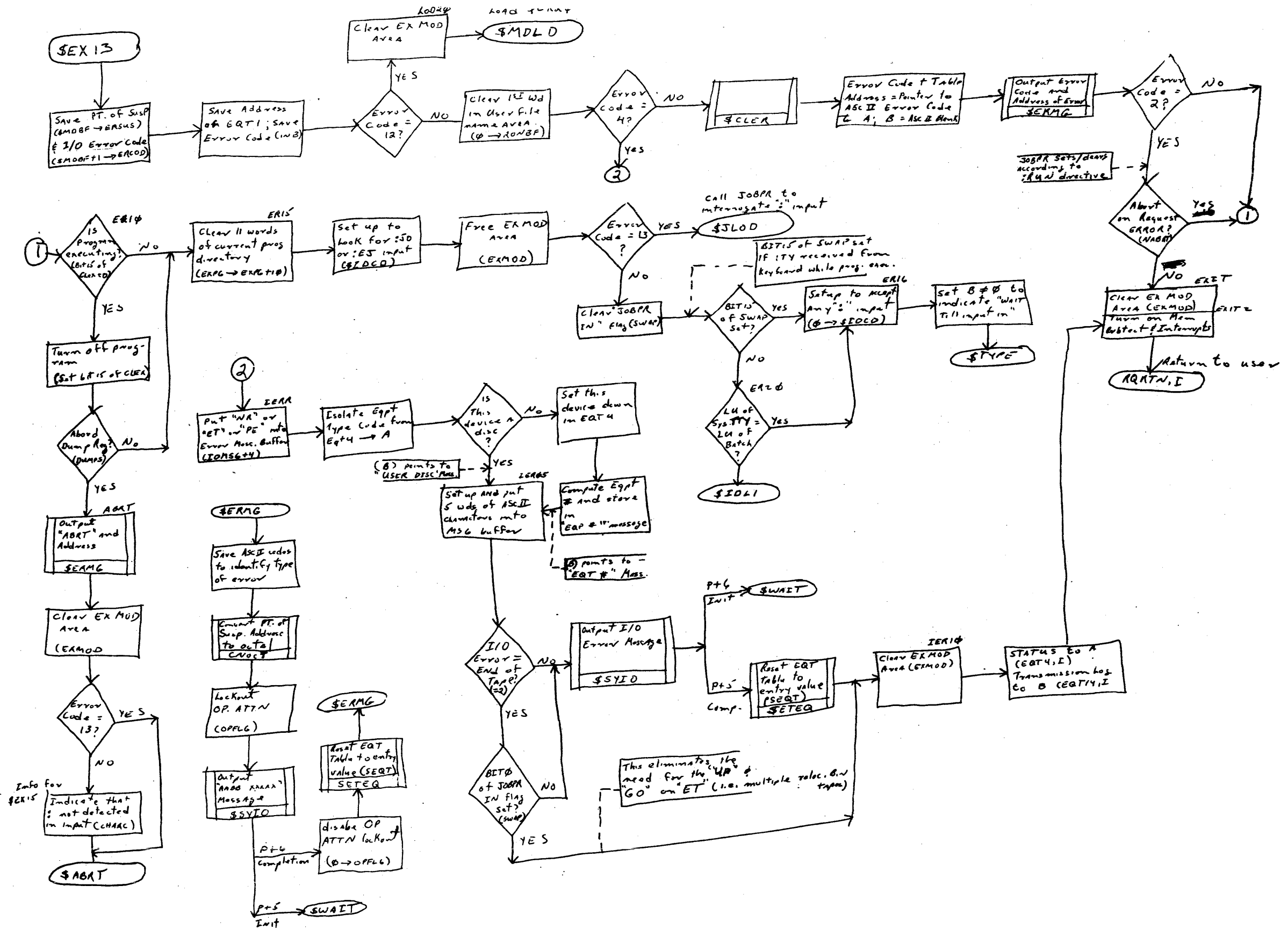

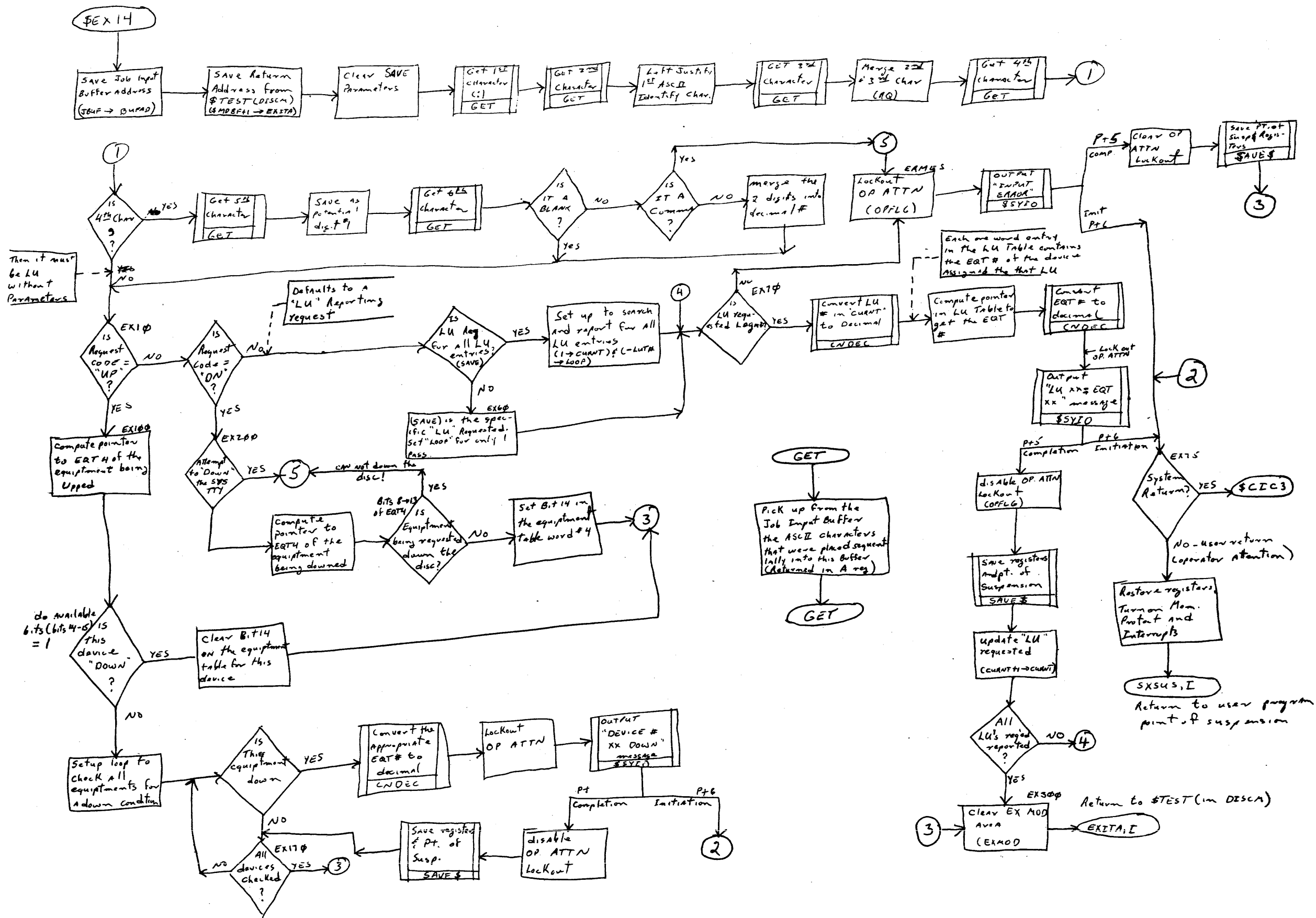

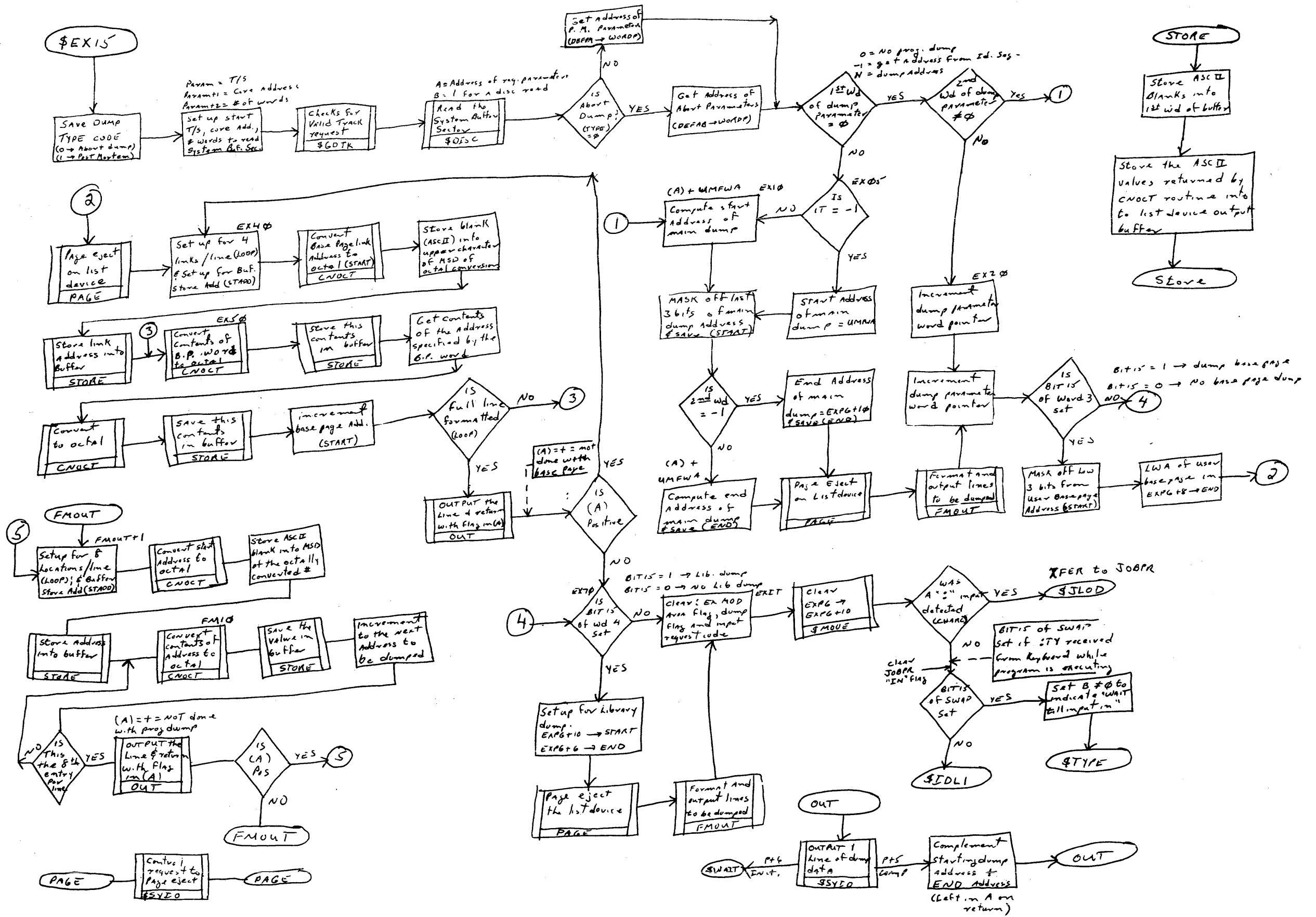

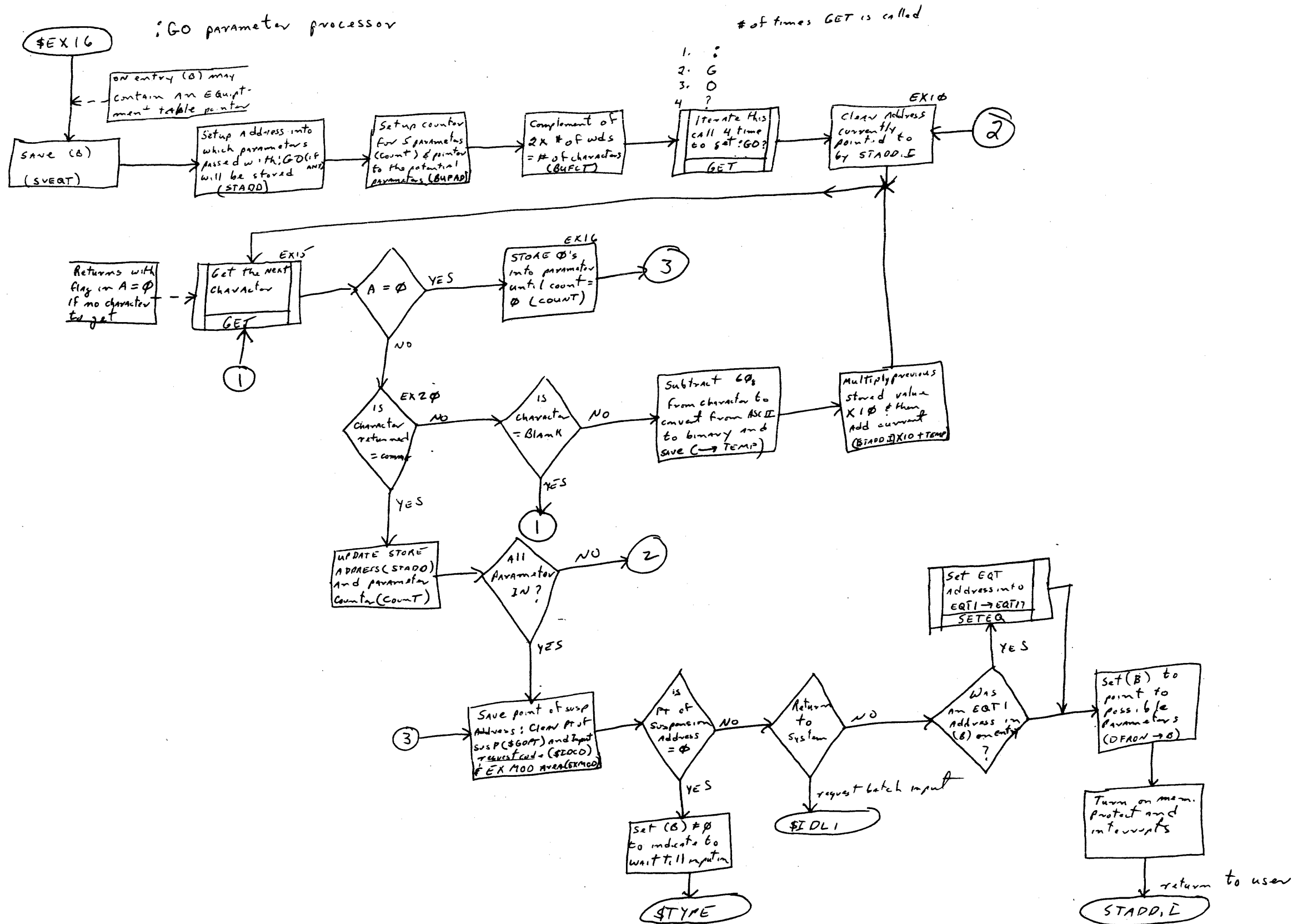

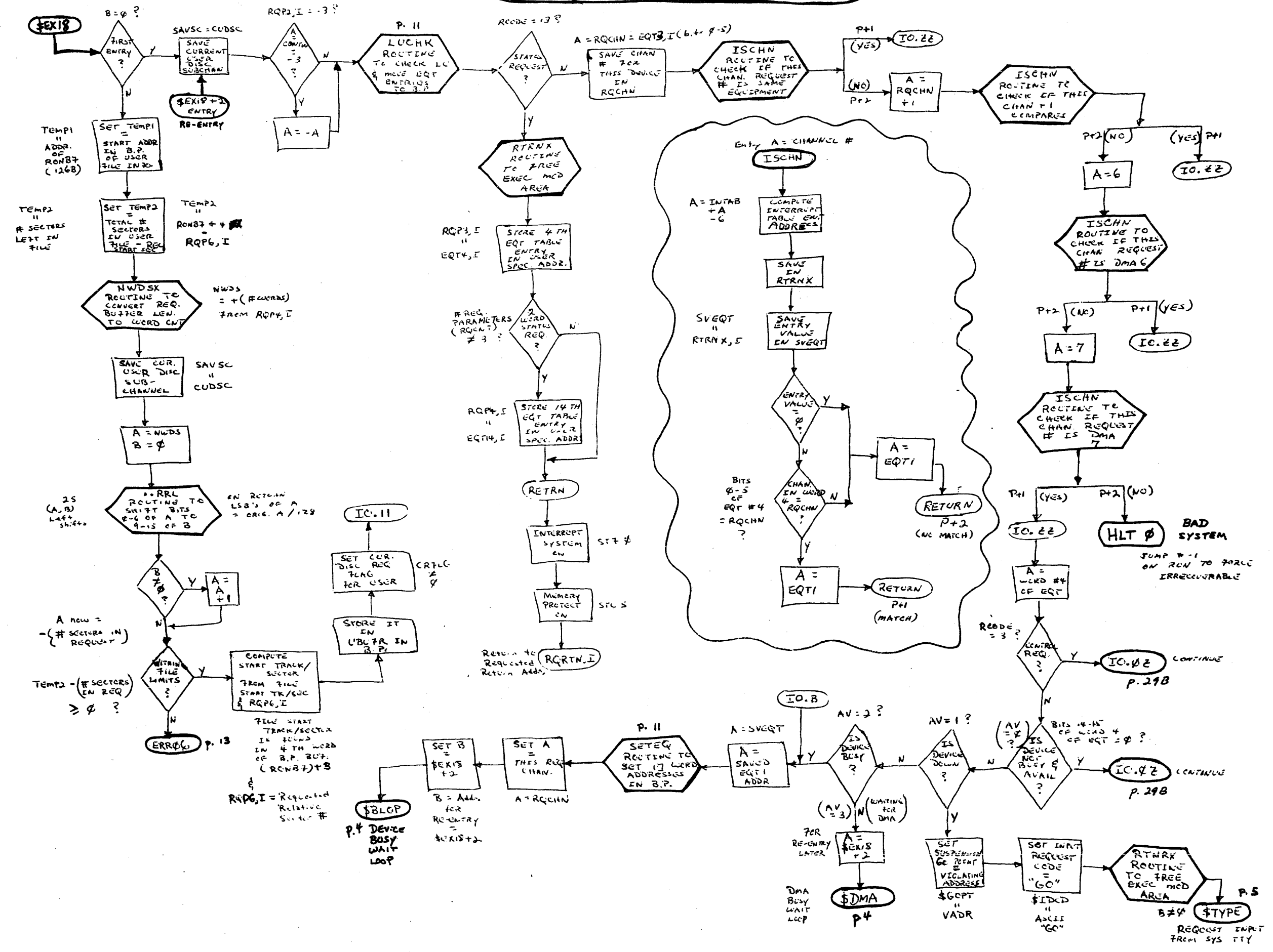

\$EX18 #2

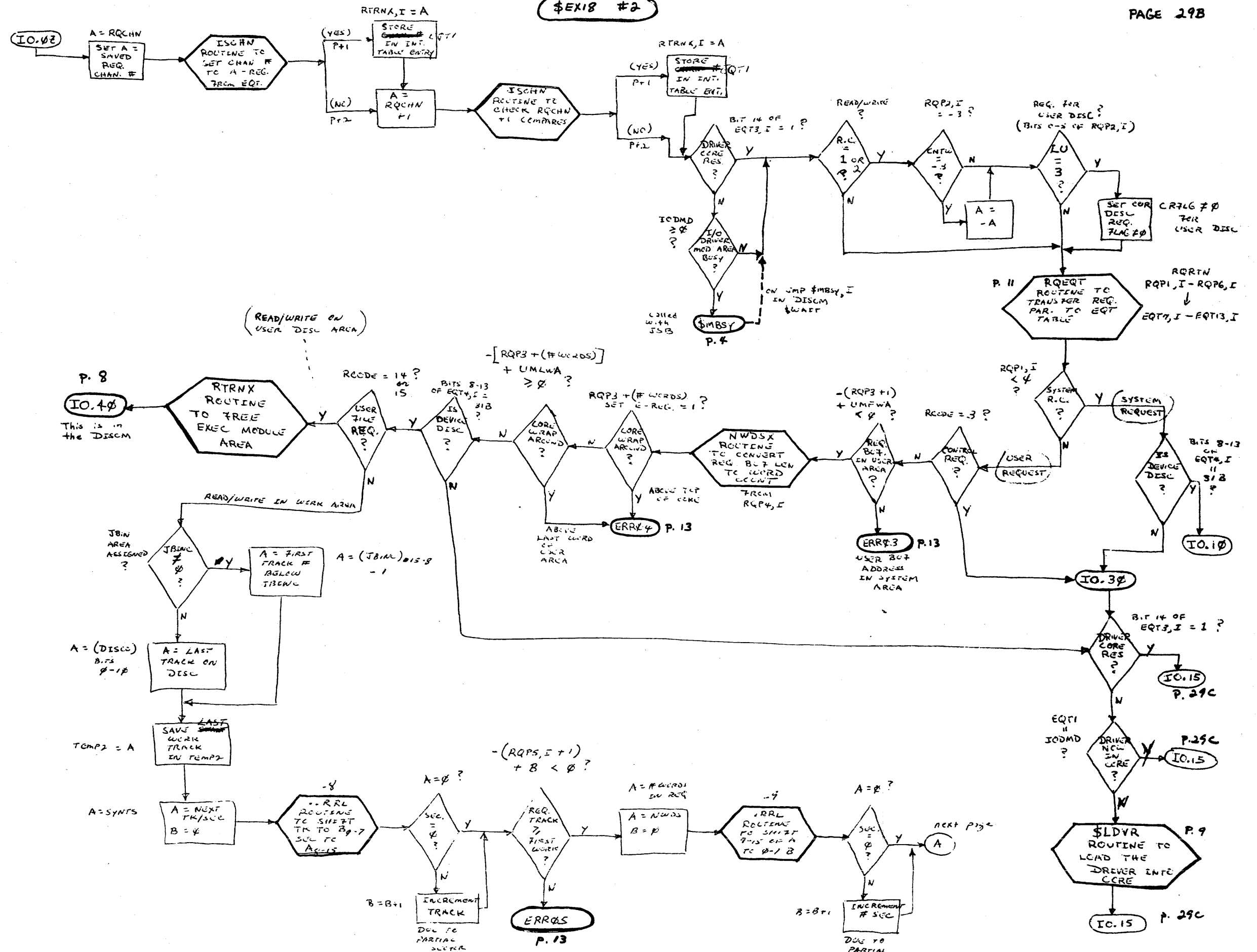

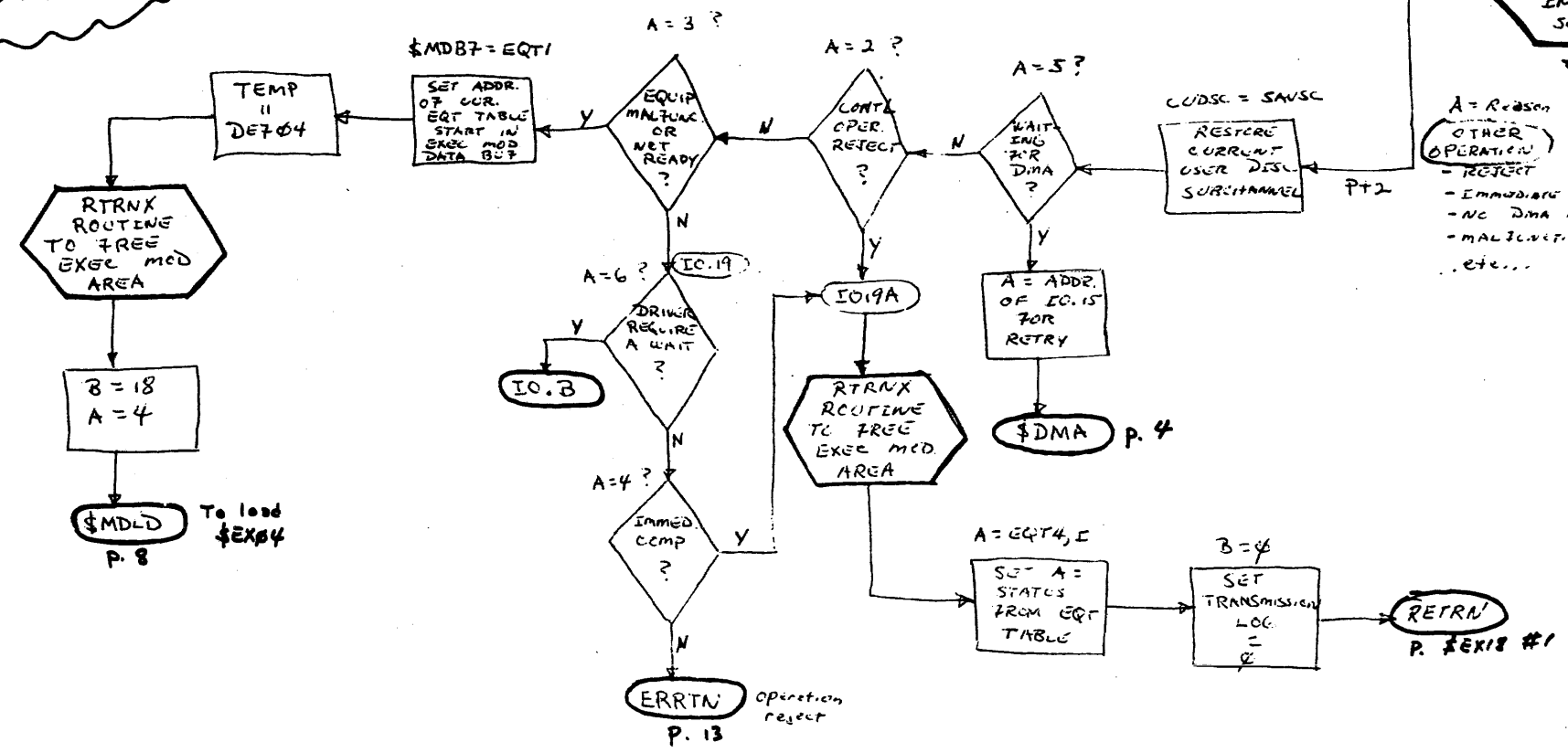
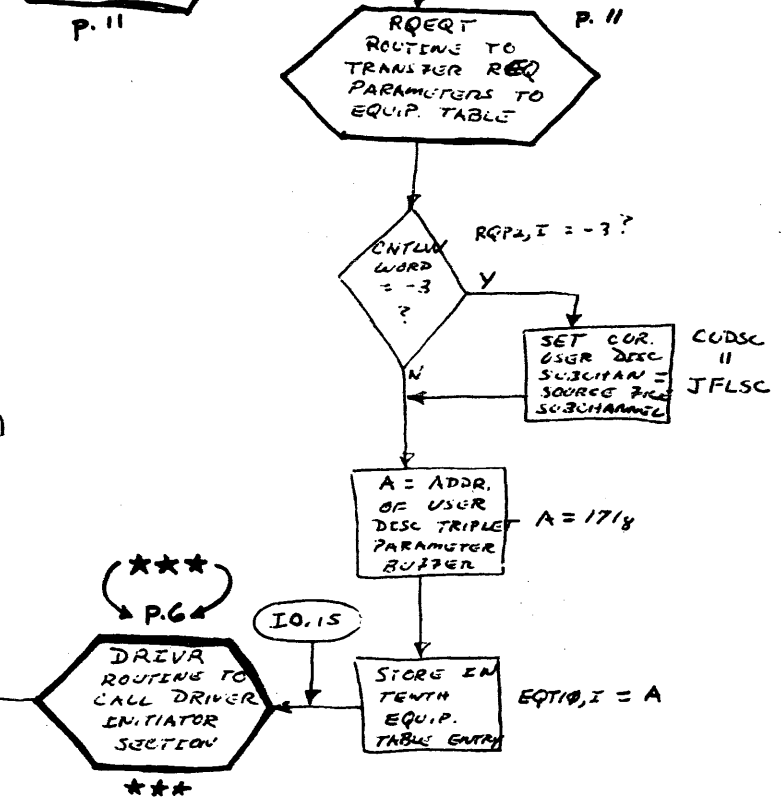
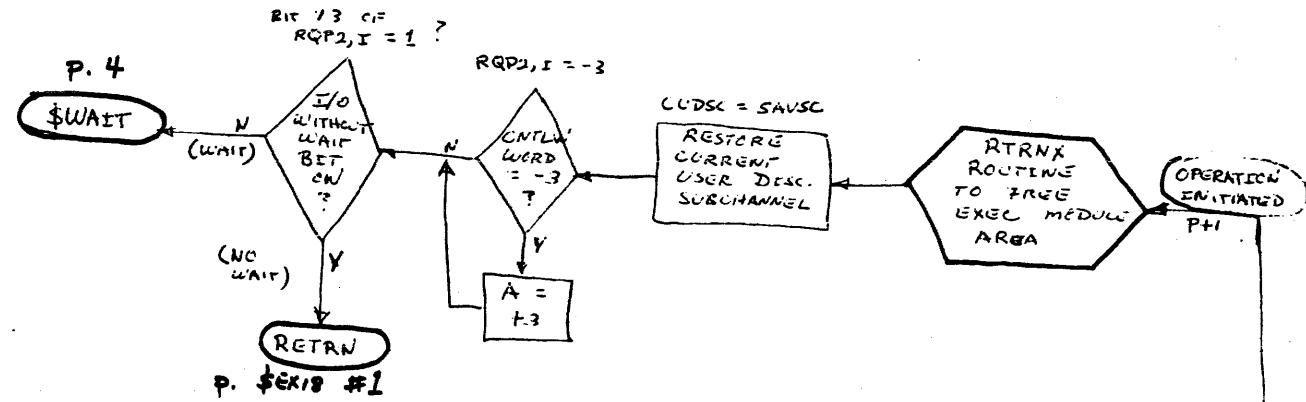
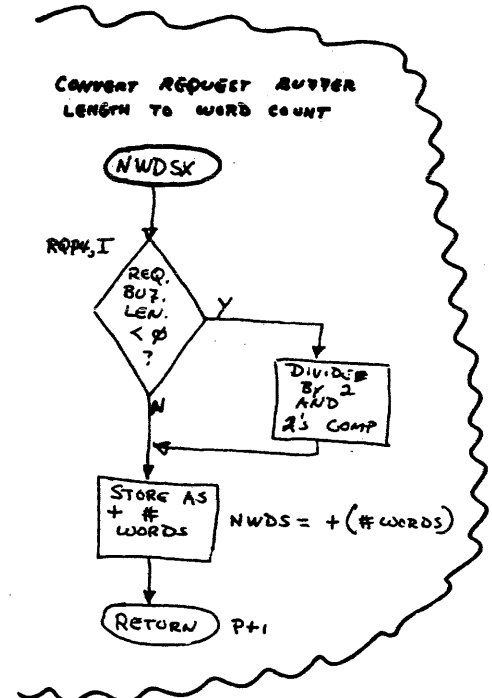
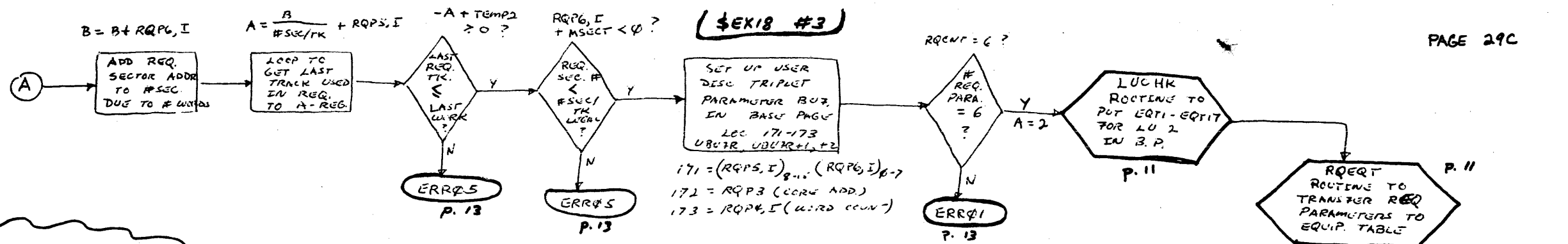

A = Reason OTHER OPERATION
 - REJECT
 - IMMEDIATE COMP.
 - NO DMA AVAIL
 - MALFUNCTION
 etc...

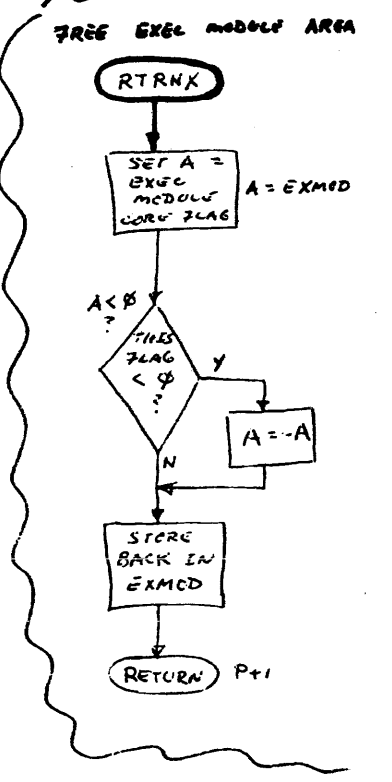

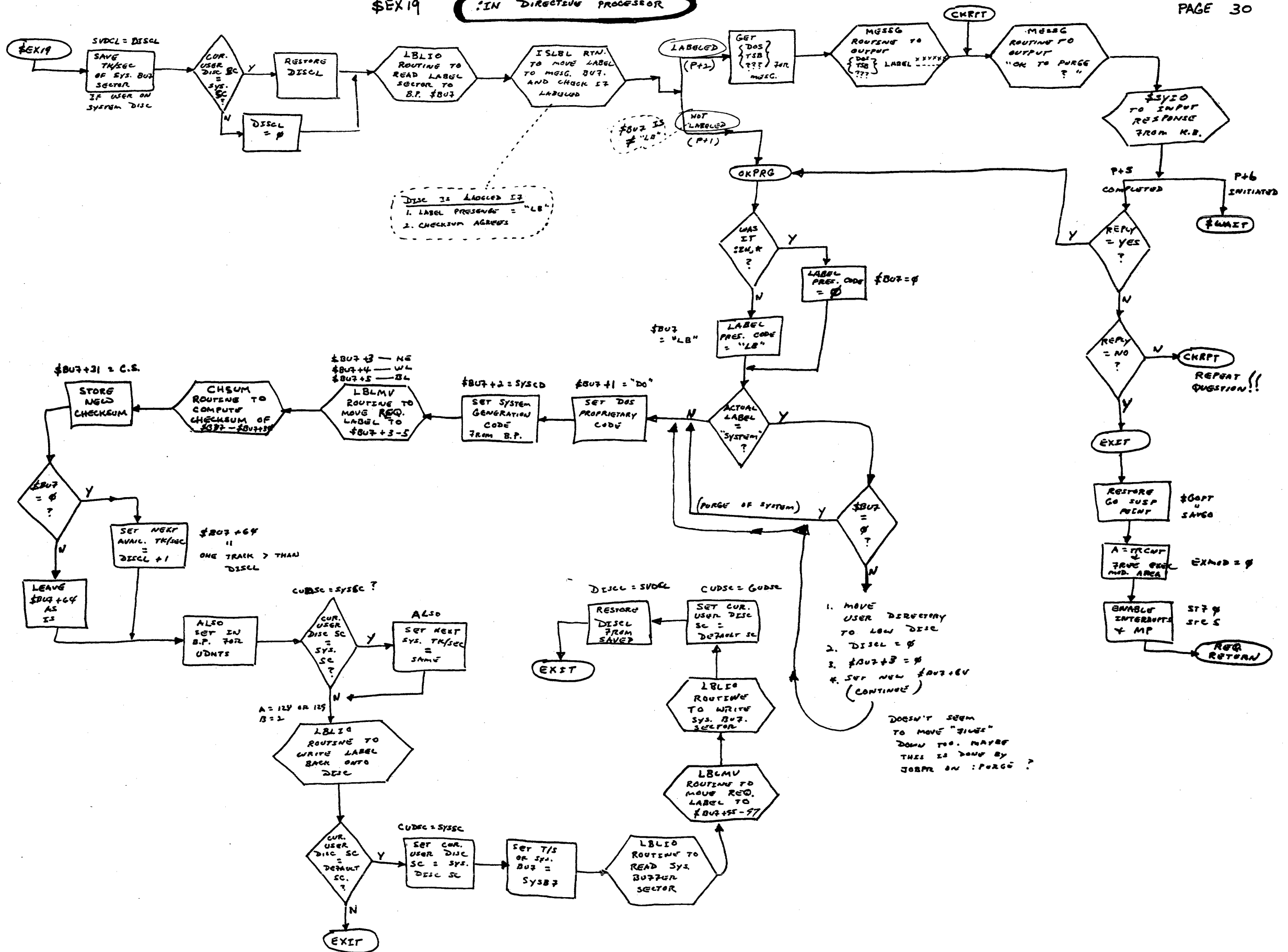

ASCII → Convert Binary to ASCII Octal or Decimal

Calling sequence: LDA <Value in binary>
JSB CNDEC/CNOCT

Return: (A) Least significant 2 digits
(B) Address of most significant digits

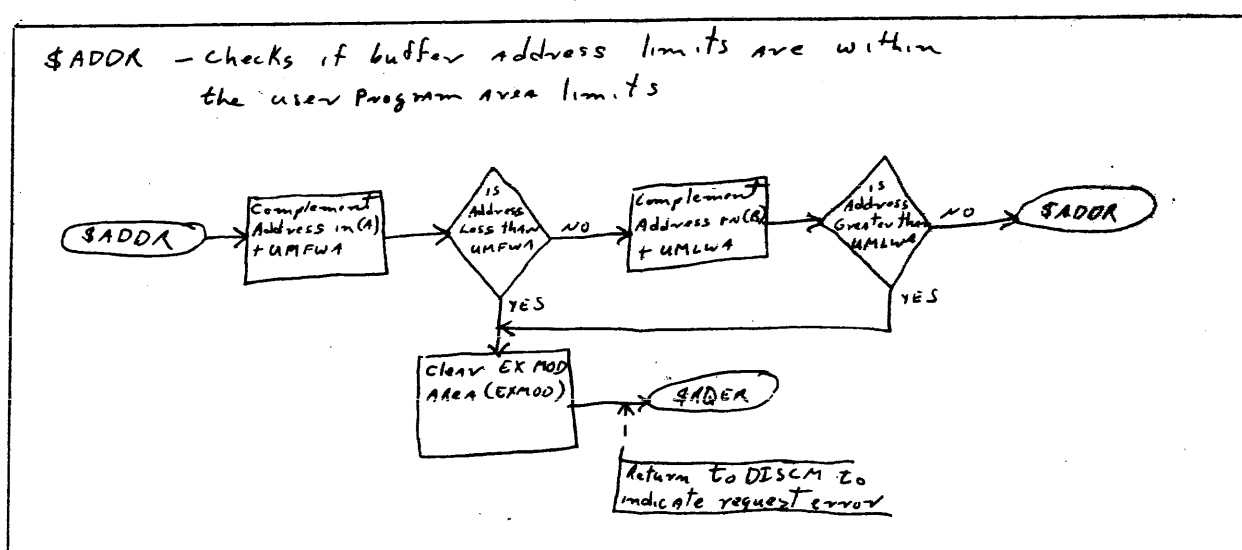
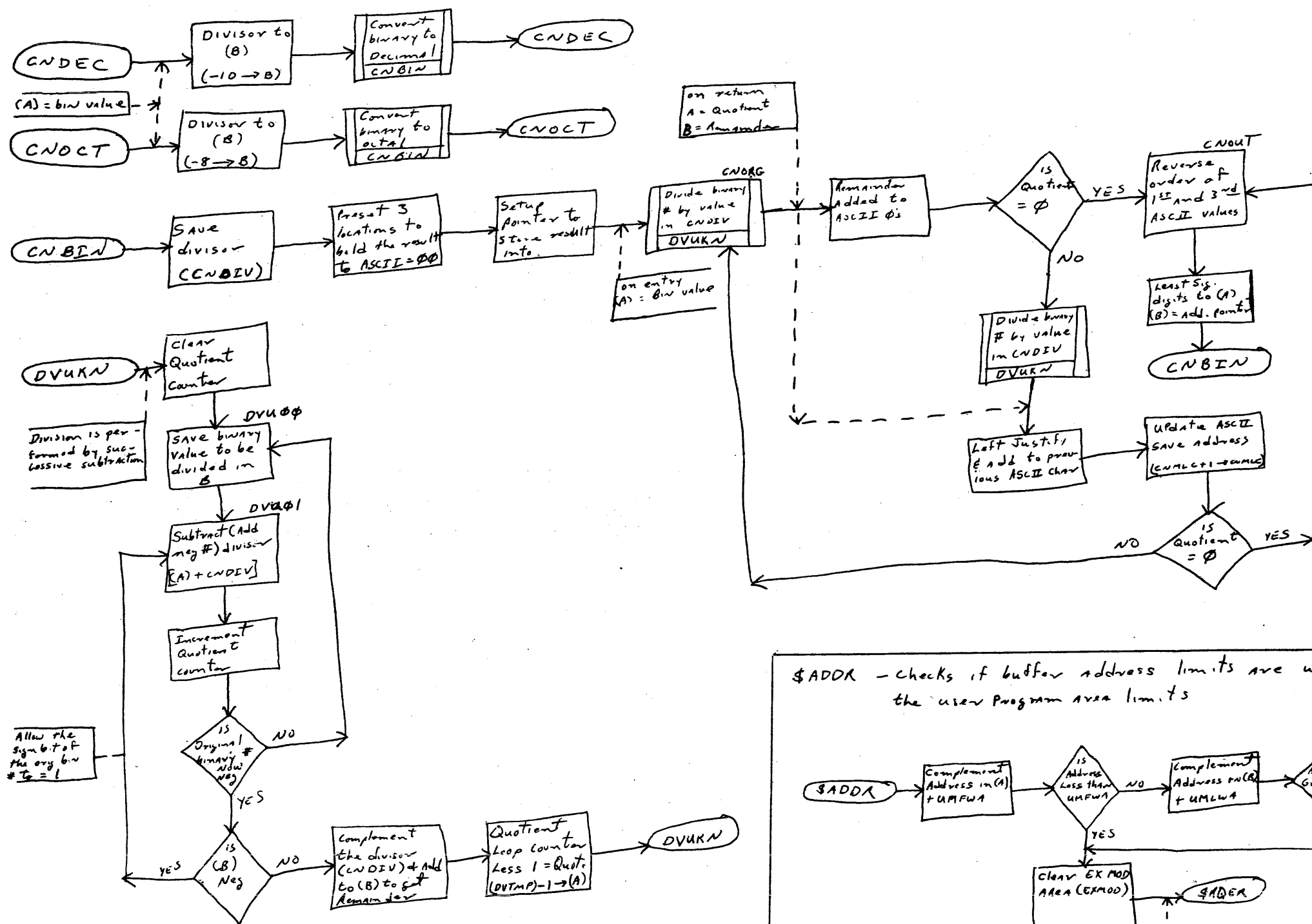

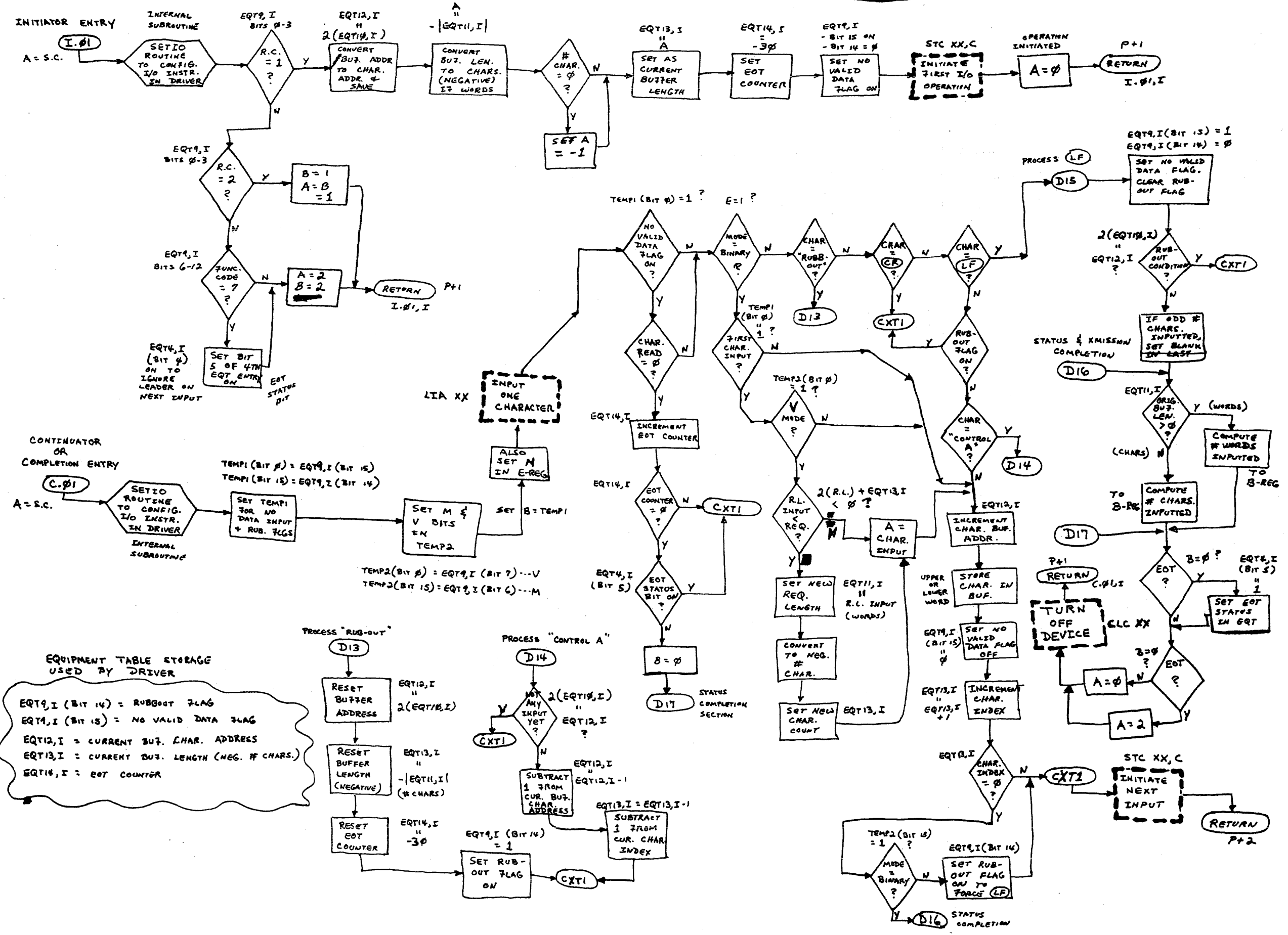

DOS/DOSM MINIMUM HARDWARE COST COMPARISON

DOS

PROVIDES MINIMUM HARDWARE CONFIGURATION CONSISTING OF:

1. 2116B Computer with 8192 Word Memory
2. Direct Memory Access, Accessory No. 12578A
3. Extended Arithmetic Unit, Accessory No 12579A
4. Memory Parity Check, Accessory No. 12591A
5. Time Base Generator, Accessory Kit No. 12539A
6. Memory Protect, Accessory Kit No. 12581A
7. Teleprinter Input/Output consisting of:
 HP 2752A Teleprinter (Modified Teletype ASR-33) with
 HP 12531B Teleprinter Input/Output Interface Kit
8. Teleprinter Input/Output, consisting of:
 HP 2754B Heavy-Duty Teleprinter (modified Teletype ASR-35) with
 HP 12531B Teleprinter Input/Output Interface Kit
9. Disc Memory consisting of:
 HP 2770A Disc Memory (368,640 words non-expandable)
 HP 2772A Disc Memory Power Supply
 HP 12606A Disc Memory Interface Kit
10. 2886A Single-Bay Cabinet

TOTAL COST

(Four-Year Lease @ \$1,690/month)

	PRICE	
	115V 60Hz	230V 50Hz
	\$20,000	\$20,000
	3,000	3,000
	3,000	3,000
	1,000	1,000
	1,000	1,000
	2,000	2,000
	1,250	1,450
	750	750
	3,850	4,250
	750	750
	17,000	17,200
	2,500	2,700
	4,000	4,000
	900	900
TOTAL COST	\$61,000	\$62,000

DOSM

PROVIDES MINIMUM HARDWARE CONFIGURATION CONSISTING OF:

1. 2114B Computer with 8K memory
2. Direct Memory Access, Accessory Kit No. 12607A
3. Memory Parity Check with Interrupt, Accessory Kit No. 12598A
4. System Console, consisting of:
 HP 2752A Teleprinter (Modified Teletype ASR-33) with
 HP 12531B Teleprinter Input/Output Interface Kit
5. System Input, consisting of:
 HP 2748A Punched Tape Reader with
 HP 12597A-002 Punched Tape Interface Kit
6. Cartridge Disc Memory System, consisting of:
 HP 2870A Disc Drive (includes HP 12536A Disc Cartridge)
 HP 2871A Disc Controller
 HP 2881A Power Supply
 HP 2882A Cabinet
 HP 12557A Disc Interface Kit

TOTAL COST

(Five-Year Lease @ \$765/Month)

	PRICE	
	115V 60 Hz	230V 50 Hz
	\$13,000	\$13,100
	1,500	1,500
	1,000	1,000
	1,250	1,450
	750	750
	1,500	1,600
	600	600
	13,500	13,650
	2,500	2,500
TOTAL COST	\$35,600	\$36,150

HP DOS/IBM 1130 COST COMPARISON

HP DOS-M		IBM 1130	
MINIMUM SYSTEM (WITH PAPER TAPE)	PURCHASE	MINIMUM SYSTEM (WITH PAPER TAPE)	PURCHASE
2114B (2.0 MICROSEC) OPTION 4 (8K MEMORY TOTAL)	\$ 8,500 4,500	1131-2A (3.6 MICROSEC) TTY/PRINTER CONSOLE 4K CORE, 500K DISC	\$ 34,610
12591A MEMORY PARITY CHECK	1,000	1134 PAPER TAPE READER (60 CHARACTERS/SEC)	1,270
12067A DIRECT MEMORY ACCESS	1,500	3623 P.T. READER ATTACHMENT	450
2870A CARTRIDGE DISC DRIVE	8,700	1055 PAPER TAPE PUNCH (14.8 CHARACTER/SEC)	900
2871A DISC CONTROLLER	2,800	7923 P.T. PUNCH ATTACHMENT	900
12557A DISC INTERFACE	2,500		
2882A DISC CABINET	600		
2881A DISC POWER SUPPLY	1,400		
2752A TELEPRINTER ASR-33	1,250		
12551B TELEPRINTER INTERFACE	750		\$ 38,130
2784A PAPER TAPE READER (500 CHARACTERS/SEC)	1,500	(WITH CAFD I/O) 1131-2A AS SHOWN ABOVE	34,610
12597A P.T. READER INTERFACE	600	1442 CARD READER/PUNCH (160 COLUMNS/SEC)	12,750
	\$ 35,600	4419 CARD READER/PUNCH ATTACHMENT	1,525
		3630 1442 INTERFACE	225
			\$ 49,110
TYPICAL SYSTEM	PURCHASE	TYPICAL SYSTEM	PURCHASE
2114B (2.0 MICROSEC) OPTION 4 (8K MEMORY TOTAL)	\$ 8,500 4,500	1131-3B (2.2 MICROSEC) TTY/PRINTER CONSOLE 8K CORE, 500K DISC	\$ 58,050
12591 MEMORY PARITY CHECK	1,000	1134 PAPER TAPE READER (60 CHAR/SEC)	1,270
2870A CARTRIDGE DISC DRIVE	8,700	3623 P.T. READER ATTACHMENT	450
2871A DISC CONTROLLER	2,800	1055 PAPER TAPE PUNCH (14.8 CHAR/SEC)	900
12557A DISC INTERFACE	2,500	7923 P.T. PUNCH ATTACHMENT	900
2882A DISC CABINET	600	1132 LINE PRINTER 82 LPM ALPHAMERIC 110 LPM NUMERIC	11,350
2881A DISC POWER SUPPLY	1,400		
2752A TELEPRINTER ASR-33	1,250	2310 DISC DRIVE 500K WORDS	12,150
12551B TELEPRINTER INTERFACE	750		
2748A PAPER TAPE READER (500 CHAR/SEC)	1,500		
12597A P.T. READER INTERFACE	600		
2753A PAPER TAPE PUNCH (120 CHAR/SEC)	3,300		
12597A P.T. PUNCH INTERFACE	600		
2767A LINE PRINTER (80 COL. 356-1110 LMP)	10,000		
12653A LINE PRINTER INTERFACE	2,500		
	\$ 52,000		\$ 85,070

DOSM HARDWARE OPTIONS

1. ADDITIONAL MEMORY
16,384 OR 32,768 WORDS ON 2116B
2. ADDITIONAL I/O CHANNELS
EXTENDERS ARE AVAILABLE FOR 2114B OR 2116B
3. TIME BASE GENERATOR (TBG)
4. EXTENDED ARITHMETIC UNIT (EAU)
AVAILABLE ONLY ON 2116B
5. MEMORY PROTECT (MP)
AVAILABLE ONLY ON 2116B
6. PHOTOREADER
7. PAPER TAPE PUNCH
8. LINE PRINTER (2778A CDC OR 80 COLUMN D.P.)
9. MARK SENSE CARD READER
10. MAGNETIC TAPE (3030A OR 7970A)
11. CALCOMP PLOTTER
12. UP TO THREE ADDITIONAL DRIVES

NOW THERE'S
A BETTER WAY

The HP DOS-M (Disc Operating System) has a significant price/performance advantage over the IBM 1130. Read on to find out why!

HP DOS-M

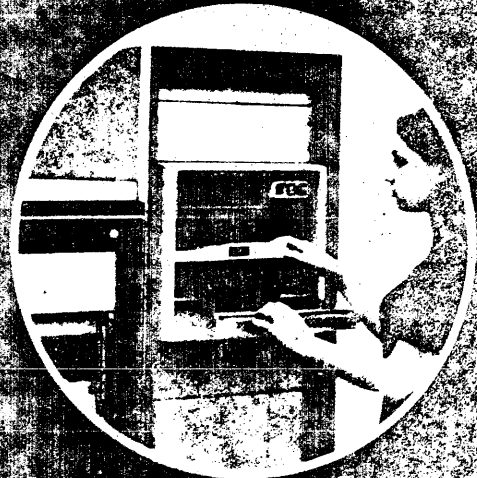
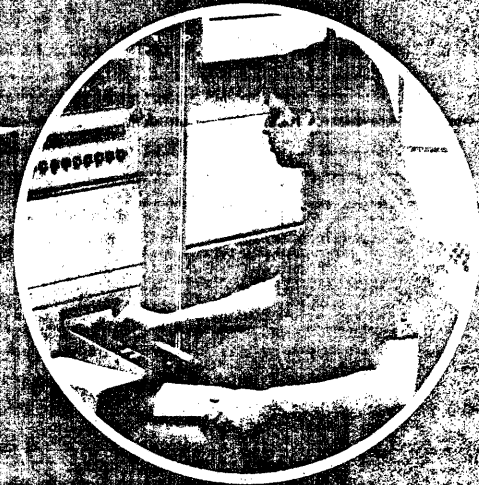

COMPANY PRIVATE

THE INFORMATION CONTAINED HEREIN IS FOR
THE INTERNAL USE OF HP EMPLOYEES ONLY.
PRICES AND SPECIFICATIONS SUBJECT TO CHANGE.

INTRODUCTION

The IBM 1130 is a desk size, word-oriented computer intended primarily for small scale scientific applications. It can also serve as a low cost processor for certain business applications that do not require high I/O speeds. IBM announced the 1130 system in 1965, and the initial customer deliveries were made an November, 1965.

Since the initial introduction, a number of software and hardware announcements have followed (i.e., a 2.2 microsecond cycle time versus 3.6, more peripheral flexibility, commercial subroutine packages, etc.).

It is purported that IBM has between 6500 and 7500 units in the field.

HP DOS-M VS IBM 1130

COMPARISON

DOS-M

IBM 1130

+ DISC STORAGE

1. MAXIMUM ON LINE	4.8 million words	2.5 million words
2. AVERAGE RANDOM ACCESS TIME	90 milliseconds	790 milliseconds

+ CORE STORAGE

1. CYCLE TIME	2 microseconds on the 2114B 1.6 microseconds on the 2116B	2.2 to 3.6 microseconds depending on the CPU model
2. MEMORY SIZE	8K in the 2114B Expandable to 32K in the 2116B	Expandable from 4K to 32K

IMPLICATIONS:

DOS-M requires much less time than the 1130 to retrieve information from core or disc. This significantly decreases the amount of overhead involved in system and user program execution. The quantity of disc storage available on line may be expanded to 4.8 million words – (approximately twice the amount available on the 1130).

+ I/O DEVICE INTERFACING

1. NUMBER OF DEVICES	A maximum of 24 peripherals may be interfaced to a DOS-M.	A maximum of 11 peripherals may be attached to an 1130.
2. KINDS OF DEVICES	Instrumentation devices may be easily interfaced to the system.	Non-IBM devices are <i>extremely difficult</i> to interface to this system.
3. DEVICES OF THE SAME TYPE	The user may attach several peripherals of the same type to the system. Note: 4 discs (max)	Normally only one peripheral of each type may be included in the system. Note: 5 discs (max) 2 printers (max)

IMPLICATIONS:

The DOS-M system is capable of supporting a much more varied range of peripherals than the 1130. Each HP system may be custom configured to the peripheral needs of the user.

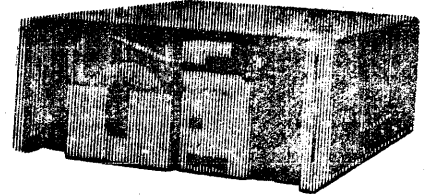
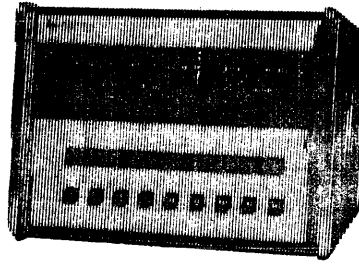
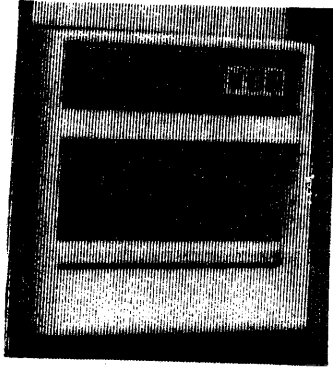

COMPARISON

DOS-M

IBM 1130

+ SYSTEM PROTECTION

- | | | |
|----------------------------|----------|------|
| 1. HARDWARE DISC PROTECT | Standard | None |
| 2. SOFTWARE SYSTEM PROTECT | Yes | Yes |

IMPLICATIONS:

Hardware disc protect insures the integrity of DOS-M; the 1130 system, on the other hand, can be destroyed by user software. (Users have called the 1130 crash prone.)

+ SYSTEM BACK UP

1. BACK UP CREATION (minimum configuration)

DOS-M system programs, user programs, and data files may be copied from the fixed portion of the disc to the disc cartridge. This back up cartridge may then be removed, stored off line, and replaced with a scratch cartridge.

IBM supplies 1130 users with a card copy of the 1130 operating system. Back up for user programs or data files, however, must be obtained by copying them from disc to punched cards. (IBM 1130s may use paper tape I/O instead of card I/O, but such systems are rare.)

2. RESTORATION FROM BACK UP (minimum configuration)

System restoration may be accomplished by copying the contents of the back up cartridge onto the fixed portion of the disc. The back up cartridge may then be removed and replaced with a scratch cartridge.

In a minimum 1130 system, the user must restore system software, user programs, and user files by copying information from punched cards to disc.

IMPLICATIONS:

On a minimum 1130 system, back up for user programs and data files may only be created on punched cards. DOS-M, on the other hand, *does not require card punch hardware* but is capable of creating a spare copy of disc resident information quickly, efficiently, and in an easily storable form — a cartridge disc pack.

If a one disc 1130 system fails, the software must be copied from card to disc — at least a 30 minute process. A DOS-M system, however, may be restored by copying software from disc to disc.

Each user at a DOS-M installation may keep an off line copy (disc pack) of a system custom configured to his needs — system programs, user programs, source files, and data files.

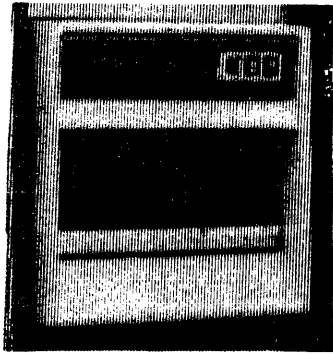

COMPARISON

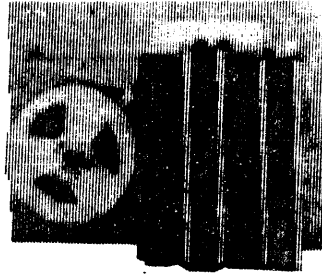

DOS-M

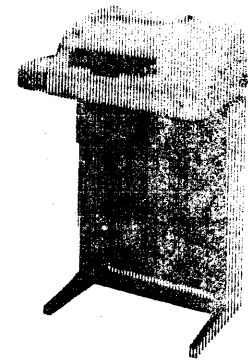

IBM 1130

+ SYSTEMS FEATURES

- | | | |
|----------------------------------|--|------|
| 1. SOURCE FILE CAPABILITY | User may store copies of source programs in named disc files on line. | none |
| 2. SOURCE FILE EDITING | User may insert, delete, or replace disc file source statements on line. | none |

IMPLICATIONS:

The ability of DOS-M to store and edit disc source programs on line makes the system extremely useful for software development work. Once source statements have been stored on disc, they may be edited and recompiled directly from disc. All source program editing on the 1130, however, must be done off line; recompilation requires the user to reload his card deck or source tape.

3. DATA FILE ADDRESSING

DOS-M allows the user to read or write data on disc by file name and relative sector or by actual track and sector address. Both addressing methods may be used in Fortran or Assembly language.

The 1130 system allows Fortran users to address data files by number in READ or WRITE statements. Assembly language disc I/O subroutines require actual track and sector addresses and therefore cannot make use of symbolic file addressing.

IMPLICATIONS:

The ability of DOS-M to address information on disc by file name makes file handling more mnemonic and simpler to use.

4. USER PROGRAM SEGMENTATION AND OVERLAY

The user must segment his program and code segment overlay requests.

Fortran *subprograms* may behave as automatically called overlay segments if the original program size exceeds available core. This "Automatic Segmentation" is not available if the main program is written in Assembly language. User controlled segmentation is also available.

IMPLICATIONS:

"Automatic Segmentation" is a strong feature of the 1130. It should be noted, however, that it will not segment main programs but treats subroutines as segments. If the main program and overlay area are larger than available core, the user must segment his program.

The use of the "Automatic Segmentation" feature may increase a program's execution time very substantially - (in direct proportion to the number of time consuming overlay requests) due to the slow (790 millisecond access time) disc.

Assembly language system development work may not use the "Automatic Segmentation" feature.

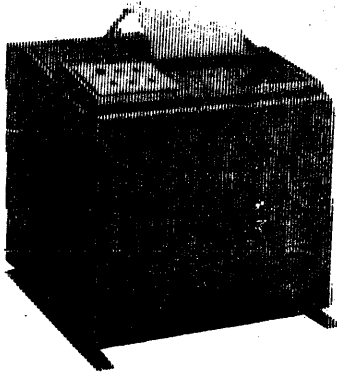

COMPARISON

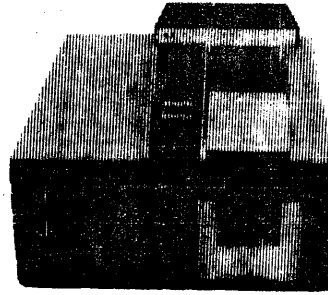

DOS-M

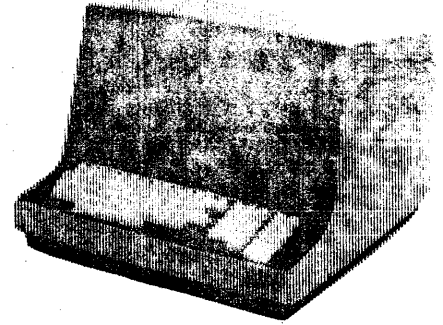

IBM 1130

5. RESIDENT MONITOR (size)

3500₁₀ locations

From 480₁₀ to 930₁₀ locations.

IMPLICATIONS:

The limited size of the 1130 monitor leaves more core available for user program execution but requires that the bulk of the system be kept on disc. By making only a small portion of the system core resident, the 1130 incurs greater disc transfer overhead during system program execution.

Since program segmentation may be used with the 1130 and DOS-M, the amount of user available core is seldom critical. Indeed, the whole purpose of a disc operating system is to use mass storage to extend limited core storage.

6. PROGRAM DEBUGGING FACILITIES

The DOS-M system permits the user to dump an octal core image of his program. Dumps may be taken whether the program terminates normally or aborts execution. An additional debug package allows the user to monitor his program's execution on line.

There are several core dump routines available for the 1130. Some of these programs must be called by the user during the execution of his program, while others must be loaded off line and executed.

IMPLICATIONS:

The core dump on abnormal program termination and the debug package of DOS-M make it very useful in a software development environment. All core dumps and debug facilities do not require any modification of the user's in line code. All on line 1130 core dumps, however, require that the user either place calls to dump routines *into his program code*, or use an *off line* dump routine.

7. I/O DEVICE REFERENCE TECHNIQUES

I/O devices are referenced using logical unit numbers. These numbers correspond to various I/O *functions* – system input, list, punch, etc.

The 1130 references peripherals with a set of numbers assigned to each type of I/O device which may be attached to the system.

Logical unit assignments may be changed on line to associate any appropriate system device with a given logical unit number.

Unit reference number assignments are permanently determined. In a Fortran program, however, the user may substitute a variable unit reference number which will be determined at execution time.

IMPLICATIONS:

DOS-M programs coded with logical unit numbers may be executed on any other DOS-M system regardless of hardware configuration. If 1130 programs use constant logical unit numbers, they may not be compatible with other 1130 hardware configurations. (Devices associated with fixed logical unit numbers cannot be changed on line in the 1130 system.)

SUPPORTING SOFTWARE

1. TRANSLATORS

Assembly language
FORTRAN II or IV
ALGOL

Assembly language
FORTRAN IV subset
RPG
COBOL (available Feb. 1971)
APL

2. USER APPLICATION PACKAGES

under development

petroleum exploration and engineering
type composition
civil engineering coordinate geometry
math pack - 20 Fortran subroutines
electric field theory
elasticity
fluid flow etc.
Statistical system
numerical surface techniques
countour map plotting
commercial subroutine package
(21 Fortran subroutines)

3. SOFTWARE COST

All presently available system software is furnished free of charge with a DOS-M system. The pricing structure on applications packages will be announced as they become available.

All IBM 1130 software developed prior to "unbundling" (June 23, 1969) is available without charge. Recently developed software, however, will be rented on a monthly basis. (The 1130 COBOL compiler will rent for \$75/month.)

IMPLICATIONS:

The quantity of applications software available is one of the strongest features of the IBM 1130. The majority of these programs are available free of charge. It should be noted, however, that OEMs will be primarily interested in the quality of the operating system itself and the ease with which the system may be used to develop specific user-oriented applications packages.

DATA COMMUNICATIONS

At this time no data communications software capability is available with the DOS-M. All hardware cards needed to implement this capability are presently available, however, and may be used by a customer to develop his own applications software.

The 1130 may act as a remote job entry work station for a larger IBM 360 operating system. In this capacity, the 1130 sends jobs via telephone lines to the larger system and outputs results sent back. If the 1130 has at least 16K of core, job output can be buffered on the disc and dumped after the remote job entry processing is terminated.

IMPLICATIONS:

The 1130 system's ability to communicate with a larger computer is certainly a powerful feature. It should be noted, however, that all programs and job control language sent to a 360 system must be 360 operating system compatible. (if an 1130 user has an assembly language program which he wishes to run with remote job entry, the program must be in IBM 360 assembly language and must have the appropriate 360 job control language statements associated with it.)

PRICING STRUCTURE

IMPLICATIONS

Although the DOS-M system purchase price is significantly (15 to 65%) less than that of a comparable 1130 system, IBM offers a variety of attractive lease/rental plans including 30 and 90 day cancellation options. This can be a significant advantage in the educational market. IBM does *not*, however, offer an educational discount on the 1130 system.

HP DOS-M	PRICE COMPARISON	IBM 1130	
MINIMUM SYSTEM (with paper tape)	PURCHASE	MINIMUM SYSTEM (with paper tape)	PURCHASE
2114B (2.0 microsec) Option 4 (8K memory total)	\$8,500 4,500	1131-2A (3.6 microsec) TTY/Printer Console 4K core, 500K disc	\$34,610
12591A Memory Parity Check	1,000	1134 Paper Tape Reader (60 characters/sec)	1,270
12067A Direct Memory Access	1,500	3623 P.T. Reader Attachment	450
2870A Cartridge Disc Drive	8,700	1055 Paper Tape Punch (14.8 character/sec)	900
2871A Disc Controller	2,800	7923 P.T. Punch Attachment	900
12557A Disc Interface	2,500		
2882A Disc Cabinet	600		
2881A Disc Power Supply	1,400		
2752A Teleprinter ASR-33	1,250	(with card I/O)	\$38,130
12531B Teleprinter Interface	750	1131-2A as shown above	\$34,610
2748A Paper Tape Reader (500 characters /sec)	1,500	1442 Card Reader/Punch (160 columns/sec)	12,750
12597A P.T. Reader Interface	600	4419 Card Reader/Punch Attachment	1,525
		3630 1442 Interface	225
	\$35,600		\$49,110

HP DOS-M	PRICE COMPARISON	IBM 1130	
TYPICAL SYSTEM	PURCHASE	TYPICAL SYSTEM	PURCHASE
2114B (2.0 microsec) Option 4 (8K memory total)	\$8,500 4,500	1131-3B (2.2 microsec) TTY/Printer Console 8K core, 500K disc	\$58,050
12591A Memory Parity Check	1,000	1134 Paper Tape Reader (60 char/sec)	1,270
12067A Direct Memory Access	1,500	3623 P.T. Reader Attachment	450
2870A Cartridge Disc Drive	8,700	1055 Paper Tape Punch (14.8 char/sec)	900
2871A Disc Controller	2,800	7923 P.T. Punch Attachment	900
12557A Disc Interface	2,500		
2882A Disc Cabinet	600		
2881A Disc Power Supply	1,400		
2752A Teleprinter ASR-33	1,250	1132 Line Printer 82 LPM Alphameric 110 LPM Numeric	11,350
12531B Teleprinter Interface	750	2310 Disc Drive 500K words	12,150
2748A Paper Tape Reader (500 char/sec)	1,500		
12597A P.T. Reader Interface	600		
2753A Paper Tape Punch (120 char/sec)	3,300		
12597A P.T. Punch Interface	600		
2767A Line Printer (80 col. 356-1110 lpm)	10,000		
12653A Line Printer Interface	2,500		
	\$52,000		\$85,070



5050 4950 (22)

IBM Enters the Mini-Computer Market As It Unveils 2 New Models, Its Cheapest

The Wall Street Journal reports that IBM's new System 7 mini-computer, which it introduced yesterday, is the world's largest computer ever built and one of them, at least, that IBM has competition for the first time with what have come to be called mini-computers.

Digital Equipment Corp. of Maynard, Mass., has been the dominant manufacturer of mini-computers, which generally are priced under \$50,000 and as low as \$5,000. Mini-computers have been used largely for calculations by scientists and engineers, but they are being applied increasingly to industrial processes and some small-business uses. Other leading manufacturers include Honeywell Inc., Varian Associates Inc., Hewlett-Packard Co. and Data General Corp.

Trading in Digital Equipment's stock on the American Stock Exchange yesterday reacted sharply to IBM's announcement. Digital Equipment closed at \$61.875, down 2 1/2 cents a share. During the day it traded as low as \$57.50. IBM, traded on the New York Stock Exchange, closed at \$298.50, up \$5.60 a share.

The new IBM model that can be considered a mini-computer is the System 7, designed specifically to monitor and control industrial and laboratory processes. It may be purchased for a minimum of \$18,000 or rented for \$552 a month and up. First deliveries to customers are scheduled for November 1971.

The System 7, designed specifically to monitor and control industrial and laboratory processes, may be purchased for a minimum of \$18,000 or rented for \$552 a month and up. First deliveries to customers are scheduled for November 1971.

In Maynard, Mass., a spokesman said the System 7 is expected to be priced low and to be a mini-computer by the company's standard. He added that Digital Equipment's products have competed very well with IBM's products in the control market and that "we think we will continue to do well."

The System 7, consisting of a mainframe, a control processor, a peripheral and a control panel, electrically links a variety of other machines. It can take as many as 2,000 requests a second from memory, analyze them, and, if desired, forward the data to a larger central computer.

As do several other computers already on the market, the System 7 has a main memory made of integrated electronic circuits, rather than of the usual magnetic cores.

The System 7 isn't designed for business data processing or for direct use by an individual scientist, IBM said. However, F. J. Rodgers, president of IBM's Data Processing division, was asked if the System 7 would be available for purchase as a component of other assemblies of control systems, who currently represent a large share of the market for mini-computers. "We'll be delighted to sell this to anybody," Mr. Rodgers replied.

IBM's other new computer is the System 3 Model 6, an extension of the System 3 small-scale computer, since designated the Model 10, that was introduced in 1969. System 3 computers are aimed for the most part at businesses

has said that more than 1,000 System 3 computers have been delivered this year.

Designed for business data processing, a typical System 3 can be purchased for \$48,000 or rented for \$1,100 a month. First deliveries of the Model 6 to users of the System 3 are scheduled for next fall. IBM officials stated that the Model 6 is the Model 3 in IBM's new line of computers.

The Model 6 can be used for accounting functions, including the processing of standard programs, and also for engineering calculations in a "conventional" mode. IBM said it stores data on magnetic disks and can communicate with other IBM computers.

The two new computers aren't part of the System 370 family of machines that large general-purpose computers introduced by IBM in 1964. Both are being produced.

Model 6 also is in production in York, Pa.

DOSM ADVANTAGES AND DISADVANTAGES WITH RESPECT TO DOS

ADVANTAGES	DISADVANTAGES
<ol style="list-style-type: none">1. LOWER INITIAL SYSTEM COST.2. LOWER DISC EXPANDABLE COST.3. FLEXIBILITY IN OPTIONS (EAU, TBG, MP) SELECTION.4. USE OF 2114B OR 2116B.5. FLEXIBILITY IN DISC STORAGE MEDIUM WITH REMOVEABLE CARTRIDGE.6. DISC CONTENT PROTECTION.7. DISC LABELING CAPABILITY.8. LOWER CORE RESIDENT SYSTEM.9. INTERDISC FILE(S) TRANSFER.	<ol style="list-style-type: none">1. SLOWER DISC AVERAGE ACCESS TIME (ABOUT 100 MILLISECONDS).2. CUMBERSOME AND SOMEWHAT CONFUSING SYSTEM BOOTSTRAP.3. NO OTHER HP DISC BASED SYSTEM (RTE, TSB).4. OVERSELLING 8K FEATURE.

COMPUTER/DISC CONTROL UNIT/DISC DRIVES LAYOUT

DATA CHANNEL (HP)

DATA, STATUS, ADDRESSING

HP 2114B
OR 2116B
COMPUTER

COMMAND CHANNEL (LP)

COMMANDS, DRIVE SELECTION,
AND DRIVE ATTENTION BITS

IOMEC
CONTROL
UNIT

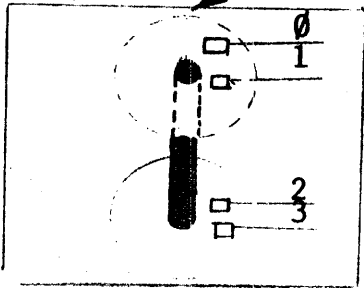

DRIVE
0

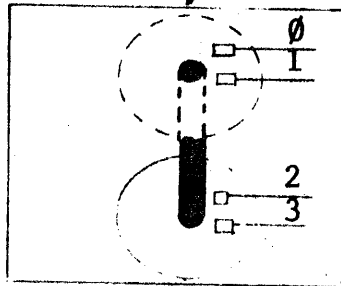

DRIVE
1

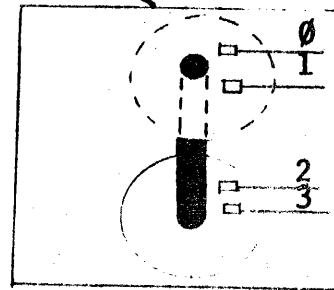

DRIVE
2

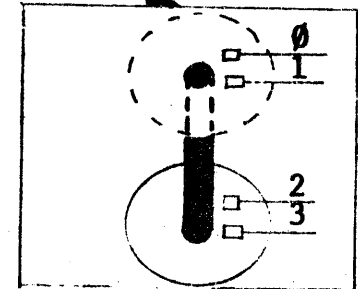

DRIVE
3

PHYSICAL ALLOCATION FOR EACH DRIVE

203 CYLINDERS
4 TRACKS PER CYLINDER
12 SECTORS PER TRACK
128 WORDS PER SECTOR

∴ TOTAL WORD CAPACITY PER DRIVE IS
 $203 \times 4 \times 12 \times 128 = 1,247,232$ WORDS

PHYSICAL ALLOCATION FOR EACH DISC

203 CYLINDERS
2 TRACKS PER CYLINDER
12 SECTORS PER TRACK
128 WORDS PER SECTOR

∴ TOTAL WORD CAPACITY PER DISC IS
 $203 \times 2 \times 12 \times 128 = 623,616$ WORDS

TWO PHYSICAL TRACKS ON CARTRIDGE DISC

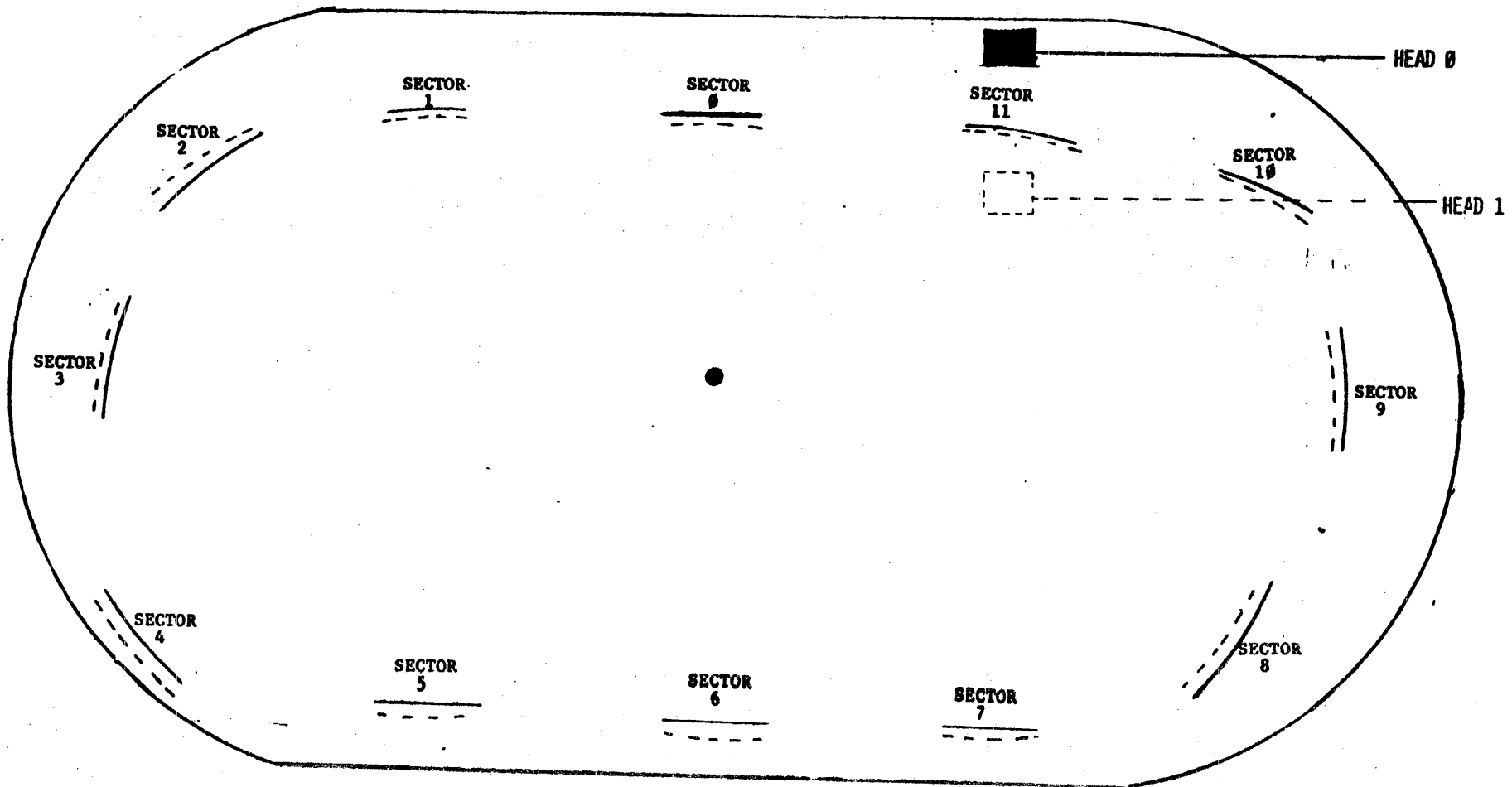

"TOP" SURFACE IS ONE PHYSICAL TRACK (12 SECTORS) FOR THIS POSITION OF HEAD 0
"BOTTOM" SURFACE IS ONE PHYSICAL TRACK (12 SECTORS) FOR THIS POSITION OF HEAD 1
THERE ARE 202 OTHER POSITIONS (CYLINDERS) THESE HEADS MAY BE MOVED TO!

[SLIDE 5]

DISC ADDRESSING

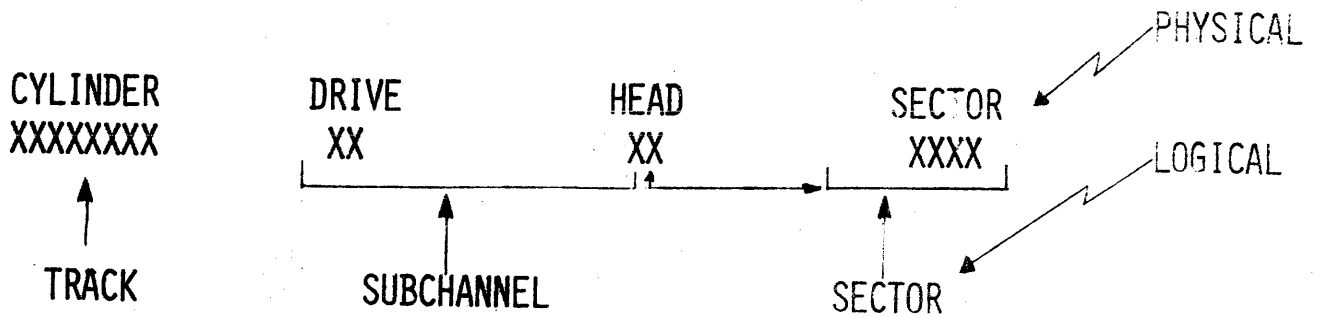

SUBCHANNEL	DRIVE	HEADS	ADDRESSED DISC
000	00	10 11	FIXED DISC DRIVE 0 HEADS 2 & 3
001		00 01	CARTRIDGE DISC DRIVE 0 HEADS 0 & 1
010	01	10 11	FIXED DISC DRIVE 1 HEADS 2 & 3
011		00 01	CARTRIDGE DISC DRIVE 1 HEADS 0 & 1
100	10	10 11	FIXED DISC DRIVE 2 HEADS 2 & 3
101		00 01	CARTRIDGE DISC DRIVE 2 HEADS 0 & 1
110	11	10 11	FIXED DISC DRIVE 3 HEADS 2 & 3
111		00 01	CARTRIDGE DISC DRIVE 3 HEADS 0 & 1

CONTENTS OF EACH SECTOR

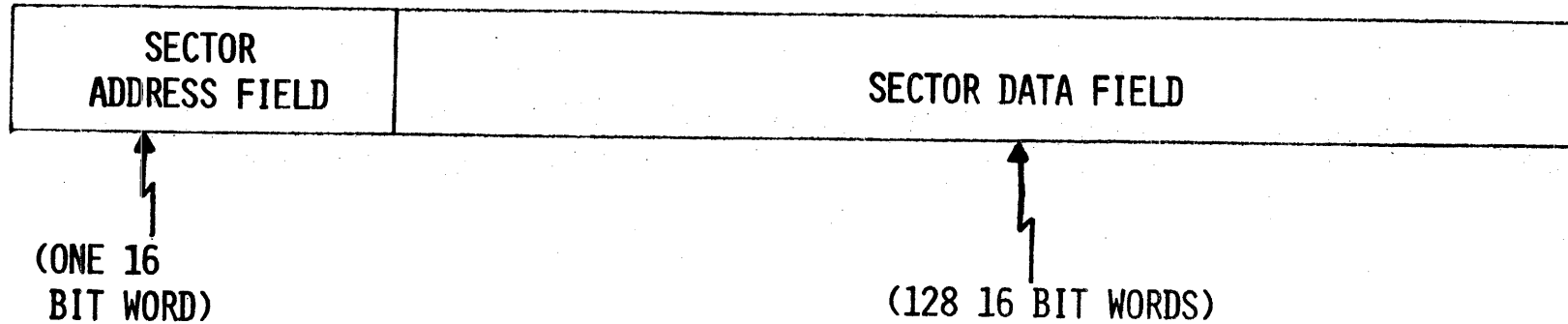

1. SECTOR ADDRESS FIELD CONTAINS:
 - 8 BITS FOR CYLINDER #
 - 2 BITS FOR HEAD #
 - 4 BITS FOR ITS SECTOR #
 - 1 BIT USED FOR DCI (DEFECTIVE CYLINDER INDICATOR)
 - 1 BIT USED FOR PCI (PROTECTED CYLINDER INDICATOR)
2. SECTOR DATA FIELD CONTAINS DATA TRANSFERRED TO AND FROM COMPUTER

NOTE: BOTH FIELDS ARE CYCLIC CHECKED BY CONTROLLER

DOSM SOFTWARE COMPONENTS (PART 1)

<u>PROGRAM</u>	<u>NAME(S)</u>	<u>GENERAL FUNCTION(S)</u>
System Generator *	DSGEN	DOSM System Generation User Disc and Cartridge Formatting
System Bootstrap *	BOOTSTRAP	Preparation of configured System bootstrap
Disc Monitor	DISCM	Interrupt Processing (\$CIC) Executive Processor (EXEC) I/O Processor (\$IORQ)
Executive Modules	\$EX01 \$EX02 \$EX03 \$EX04 \$EX05 \$EX06 \$EX07 \$EX08 \$EX09 \$EX10 \$EX11 \$EX12 \$EX13 \$EX14 \$EX15 \$EX16 \$EX17 \$EX18 \$EX19 \$EX20	Disc Work Track Status Disc Work Track Limits Program Completion Program Suspension Program Segment Load ✓ User File Name Search ✓ Current Time Processor Real-Time Disc Allocation Execution Time :EQ Processor Load and Execute Program System File Name Search System Startup Error Message Processor Execution Time :UP, :DN, :LU Processor Abort and Post Mortem Dump :GO Parameter Processor :UD Processor I/O Initiation Processor :IN Processor Disc Parity Error Processor
Executive Module Subroutines	\$LBL ✓\$SRCH \$ADDR ASCII DUMRX	Service Routines for Label Checking Search System or User Directory Buffer Address Validity Check Convert Binary to ASCII RTE simulation routines
Special DOSM Drivers	DVR05 DVR31	System Teleprinter Driver Moving Head Disc Driver

* This is an ABSOLUTE program executed in a separate process from the DOSM system

DOSM SOFTWARE COMPONENTS (PART 3)

 DOS AND DOSM DRIVERS

EQUIPMENT TYPE CODE (DVR__)	DEVICE	DOS ONLY	DOSM ONLY	BOTH	DMA
00	Teleprinter			X	
01	Photoreader			X	
02	Punch			X	
05	Teleprinter		X		
10	Plotter			X	
12	2778A CDC Line Printer			X	
15	Mark Sense Card Reader			X	X
16	Data Products Line Printer (80 column) <i>2767</i>			X	
22	3030 Mag. Tape			X	X
23	7970 Mag. Tape			X	X
30	Fixed Head Disc	X			X
31	Moving Head Disc (IOMEC)		X		X
32	Moving Head Disc (ISS) <i>11 platters per</i>		X		X

Equipment Type Code Numbering Convention

- 00 - 07 Paper Tape Devices
 - 10 - 17 Unit Record Devices
 - 20 - 37 Mass Storage Devices
- } Odd # for INPUT
 } Even # for OUTPUT

DOSM SOFTWARE COMPONENTS (PART 4)

* LIBRARIES *

<u>NAME</u>	<u>RELOCATABLE LIBRARY TYPE</u>
F2N.V	NON-EAU RTE/DOS/DOSM (no Formatter)
F2E.V	EAU RTE/DOS/DOSM (no Formatter)
F4D.V	RTE/DOS/DOSM FORTRAN IV with FORTRAN IV Formatter (Double Precision)
_____	RTE/DOS/DOSM HP FORTRAN Formatter (no Double Precision)
_____	RTE/DOS/DOSM Plotter

where V = the revision letter (A, B, C)

NOTES:

1. System must include F2N.V or F2E.V even if FORTRAN IV library (F4D.V) is to be included. This is because the FORTRAN IV library references routines whose entry points are in F2N.V and F2E.V libraries.
2. RTE/DOS/DOSM HP FORTRAN Formatter is separate from F2N.V and F2E.V due to FORTRAN IV library (F4D.V) containing a formatter.

DOSM DISC TO MEMORY TRANSFERS (GENERAL)

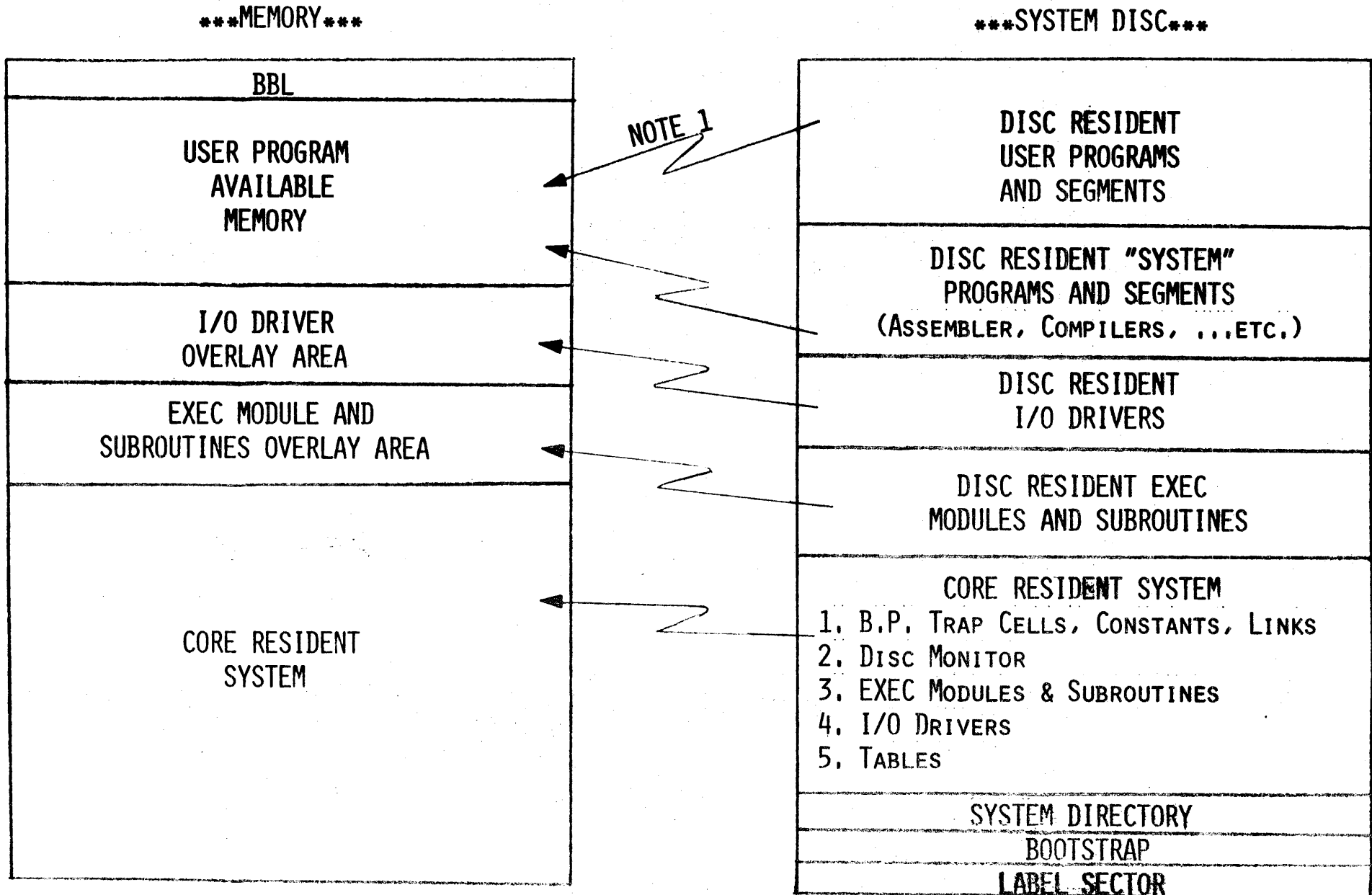

NOTE 1: MAY BE FROM "SYSTEM" DISC OR USER DISC(S)

DOSM GENERAL CORE LAYOUT

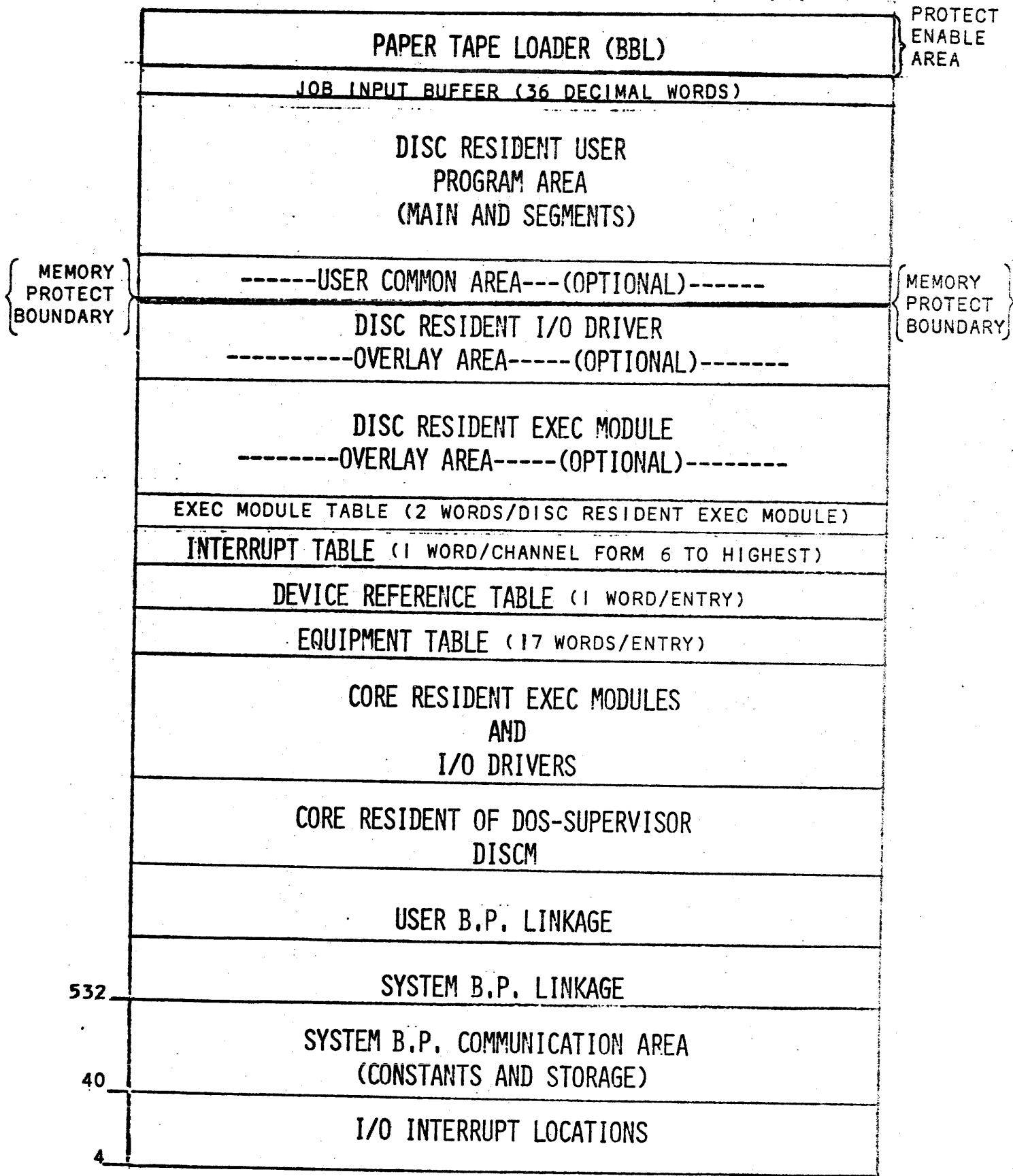

EQUIPMENT TABLE ENTRY FORMAT

WORD

CONTENTS

1	DRIVER "INITIATION" SECTION ADDRESS															
2	DRIVER "CONTINUATION" SECTION ADDRESS															
3	D	R							UNIT #							CHANNEL #
4	Av	EQUIPMENT TYPE CODE						STATUS								
5	(SAVED FOR DRIVER USE)															
6	(SAVED FOR DRIVER USE)															
7	REQUEST RETURN ADDRESS															
8	REQUEST CODE															
9	CURRENT I/O REQUEST CONTROL WORD															
10	REQUEST BUFFER ADDRESS															
11	REQUEST BUFFER LENGTH															
12	TEMPORARY OR DISC TRACK #															
13	TEMPORARY OR STARTING SECTOR #															
14	TEMPORARY STORAGE FOR DRIVER															
15	UPPER MEMORY ADDRESS OF MAIN DRIVER AREA															
16	UPPER MEMORY ADDRESS OF DRIVER LINKAGE AREA															
17	STARTING TRACK #								STARTING SECTOR #							
BITS	15	14	13	12	11	10	9	8	7	6	5	4	3	2	1	0

0's IF
CORE-
RESIDENT

- D = 1 IF DMA CHANNEL REQUIRED.
- R = 1 IF DRIVER TYPE IS CORE-RESIDENT.
- UNIT # MAY BE USED FOR SUB-CHANNEL ADDRESSING.
- CHANNEL # I/O SELECT CODE FOR DEVICE (LOWER NUMBER IF MULTIBOARD INTERFACE.)

- Av = 0 - UNIT NOT BUSY AND AVAILABLE
- = 1 - UNIT DISABLED (DOWN)
- = 2 - UNIT BUSY
- = 3 - UNIT WAITING FOR AN AVAILABLE DMA CHANNEL SYSTEM

STATUS - ACTUAL OR SIMULATED UNIT STATUS AT END OF OPERATION.
(DRIVER MUST SET THIS FIELD)

EQUIPMENT TYPE CODE - IDENTIFIES TYPE OF DEVICE AND ASSOCIATED SOFTWARE DRIVER. ASSIGNED EQUIPMENT TYPE CODES IN OCTAL AR

00-07	PAPER TYPE DEVICES
00	TELEPRINTER
01	PUNCHED TAPE READER
02	HIGH SPEED PUNCH
05	TELETYPE (SYSTEM)
10-17	UNIT RECORD DEVICES
10	RESERVED FOR PLOTTER
12	LINE PRINTER
15	MARK SENSE CARD READER
20-37	MAGNETIC TAPE/MASS STORAGE AND OTHER DEVICES CAPABLE OF BOTH INPUT AND OUTPUT.
22	3030 MAGNETIC TAPE
31	MOVING-HEAD DISC

FOR EQUIPMENT TYPE CODES 1 THROUGH 17, ODD NUMBER INDICATE INPUT DEVICES AND EVEN NUMBER INDICATE OUTPUT DEVICES (EXCEPT 05, WHICH IS BOTH INPUT AND OUTPUT).

(THIS FIELD
SET BY
SYSTEM)

AVAILABLE
FOR
DRIVER
TEMPORARY

THE DEVICE REFERENCE TABLE

THE DEVICE REFERENCE TABLE PROVIDES FOR LOGICAL ADDRESSING OF PHYSICAL UNITS DEFINED IN THE EQUIPMENT TABLE. THE DRT CONSISTS OF ONE WORD ENTRIES CORRESPONDING TO THE RANGE OF USER-SPECIFIED LOGICAL UNITS (1 TO N, WHERE $n \leq 63$). THE CONTENTS OF THE WORD CORRESPONDING TO A LOGICAL UNIT IS THE RELATIVE POSITION OF THE EQT ENTRY DEFINING THE PHYSICAL UNIT.

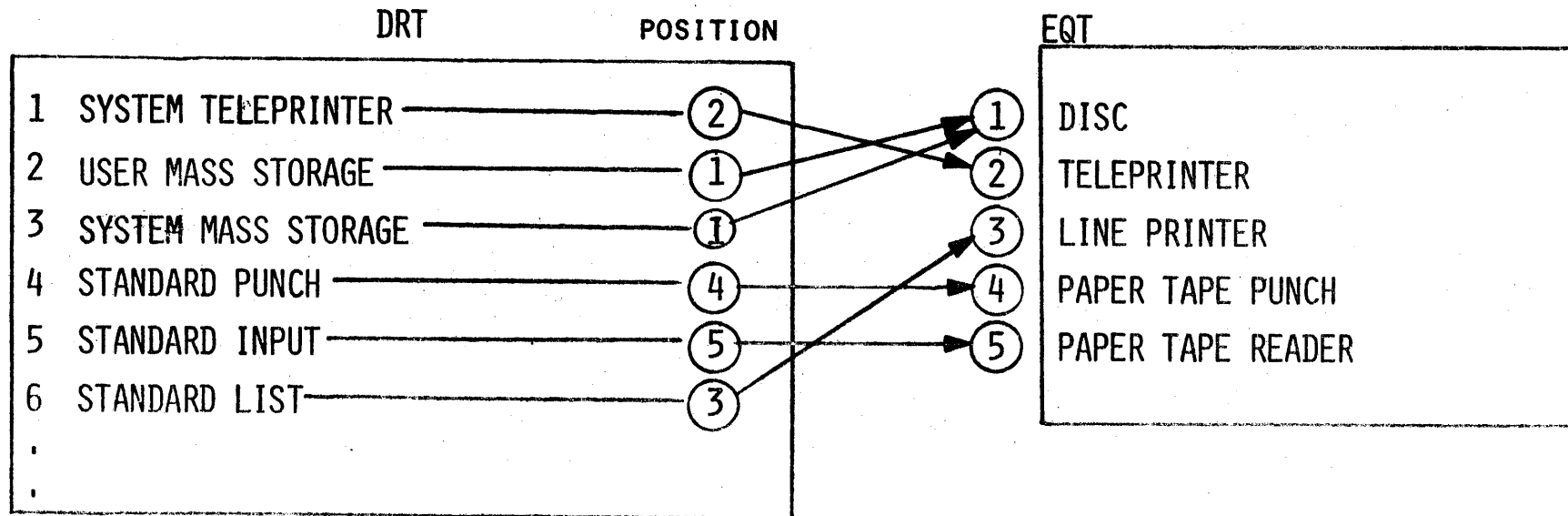

THE INTERRUPT TABLE

THE INTERRUPT TABLE CONTAINS A ONE WORD ENTRY FOR EACH I/O DEVICE. THESE ENTRIES CONTAIN THE ADDRESSES OF EQUIPMENT TABLE ENTRIES FOR DEVICES ASSOCIATED WITH THESE CHANNELS.

CHANNEL
NUMBER

6

7

10

11

12

13

DMA CHANNEL 1 COMPLETION	*
DMA CHANNEL 2 COMPLETION	*
Ø10542	**
Ø10521	**
Ø00000	
Ø10604	**

EQUIPMENT TABLE

10521

10542

10563

10604

Ø INDICATES ILLEGAL INTERRUPT

* THE ADDRESSES IN THESE LOCATIONS CHANGE DYNAMICALLY AS DMA CHANNELS ARE ASSIGNED TO DIFFERENT DEVICES.

** THE ADDRESSES IN THESE LOCATIONS CHANGE DYNAMICALLY AS DIFFERENT EQT ENTRIES ARE USED FOR GIVEN I/O CHANNEL.

SYSTEM DISC ALLOCATION

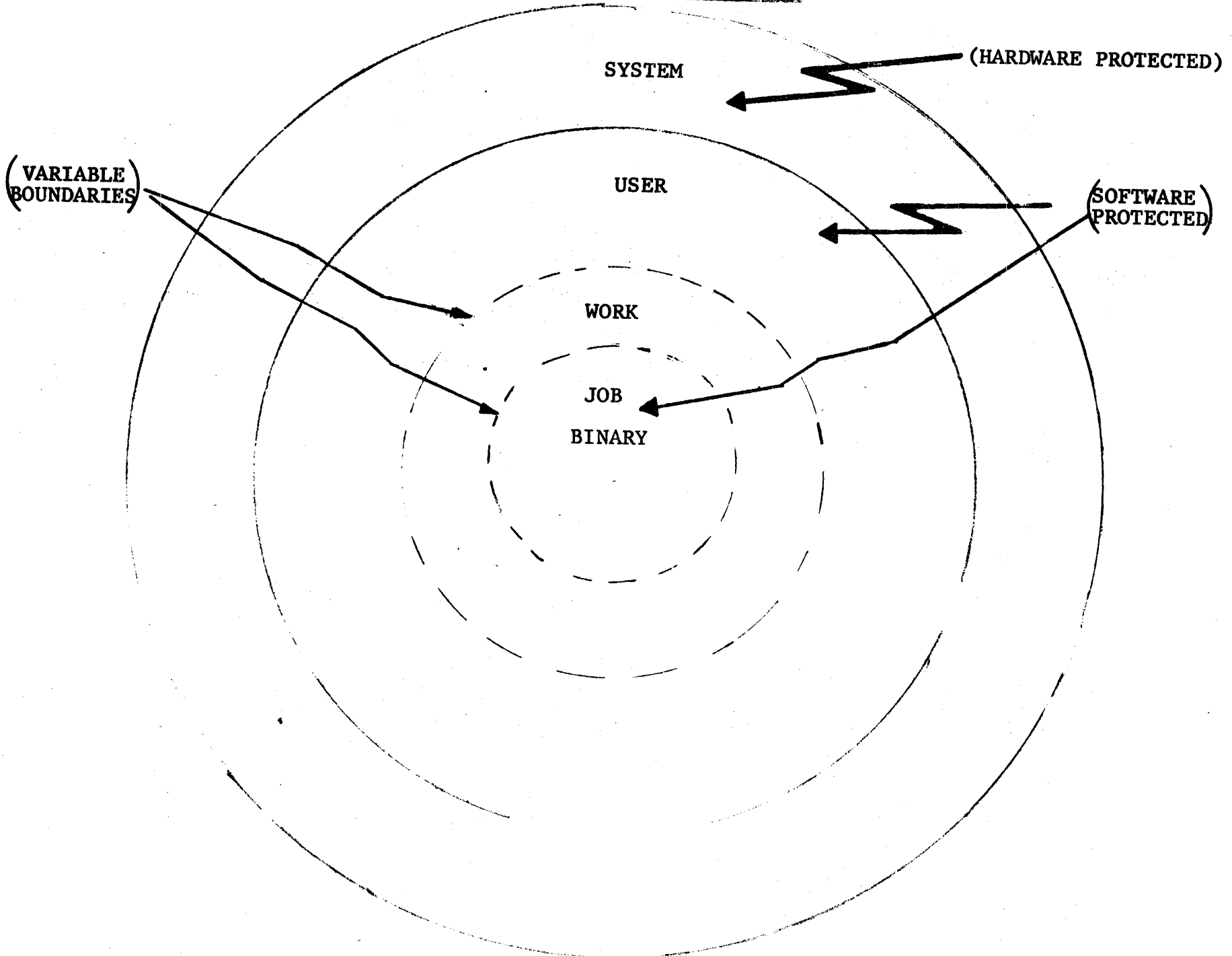

DOSM "SYSTEM" DISC LAYOUT

INCREASING
DISC
ADDRESS

(HARDWARE PROTECTED)

(SOFTWARE PROTECTED)

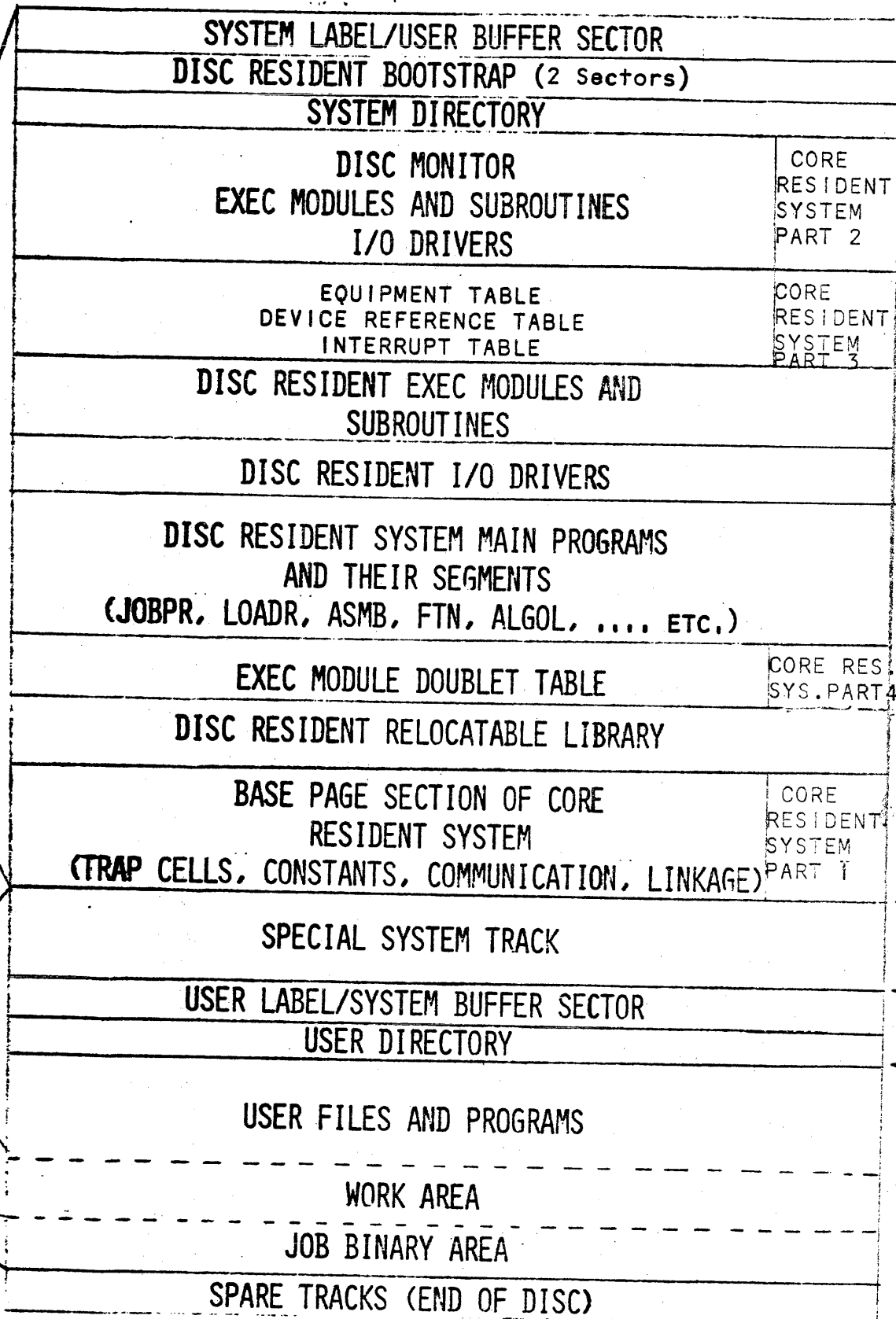

T = STARTS ON TRACK BOUNDARY

(PURE)
DOSM "USER" DISC LAYOUT

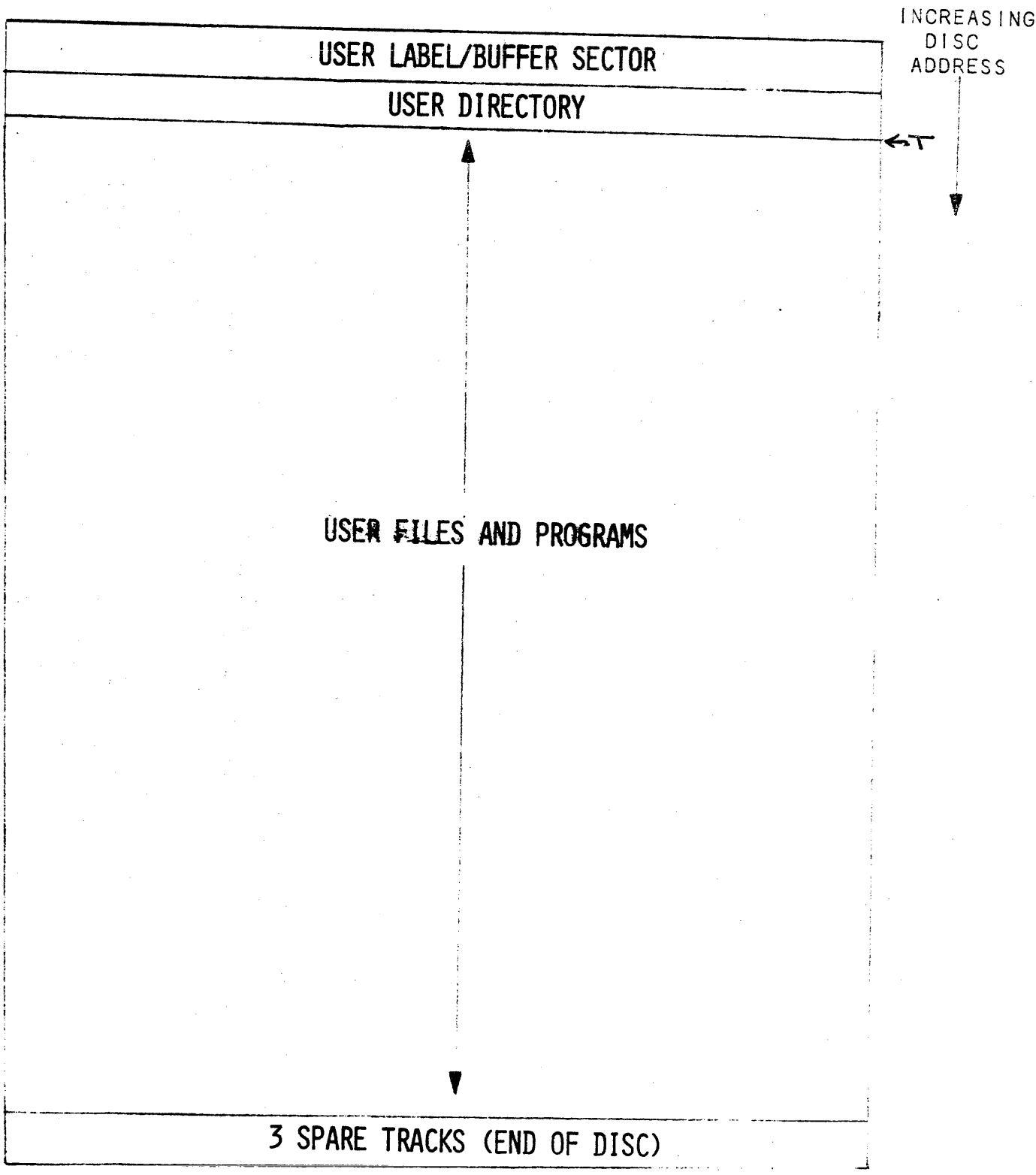

"SYSTEM" DISC (LABEL SECTORS DESCRIPTION)

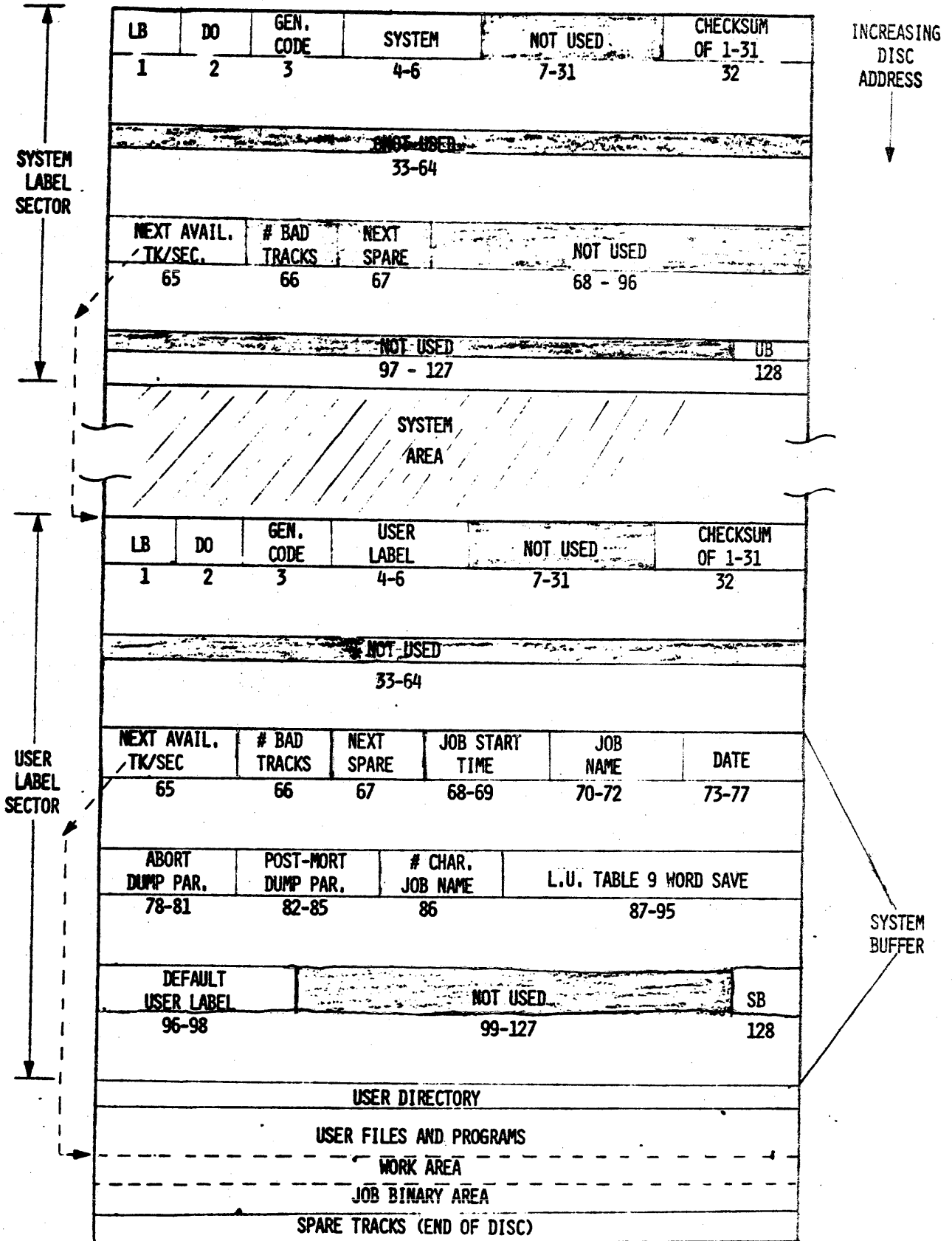

"USER" DISC (LABEL SECTOR DESCRIPTION)

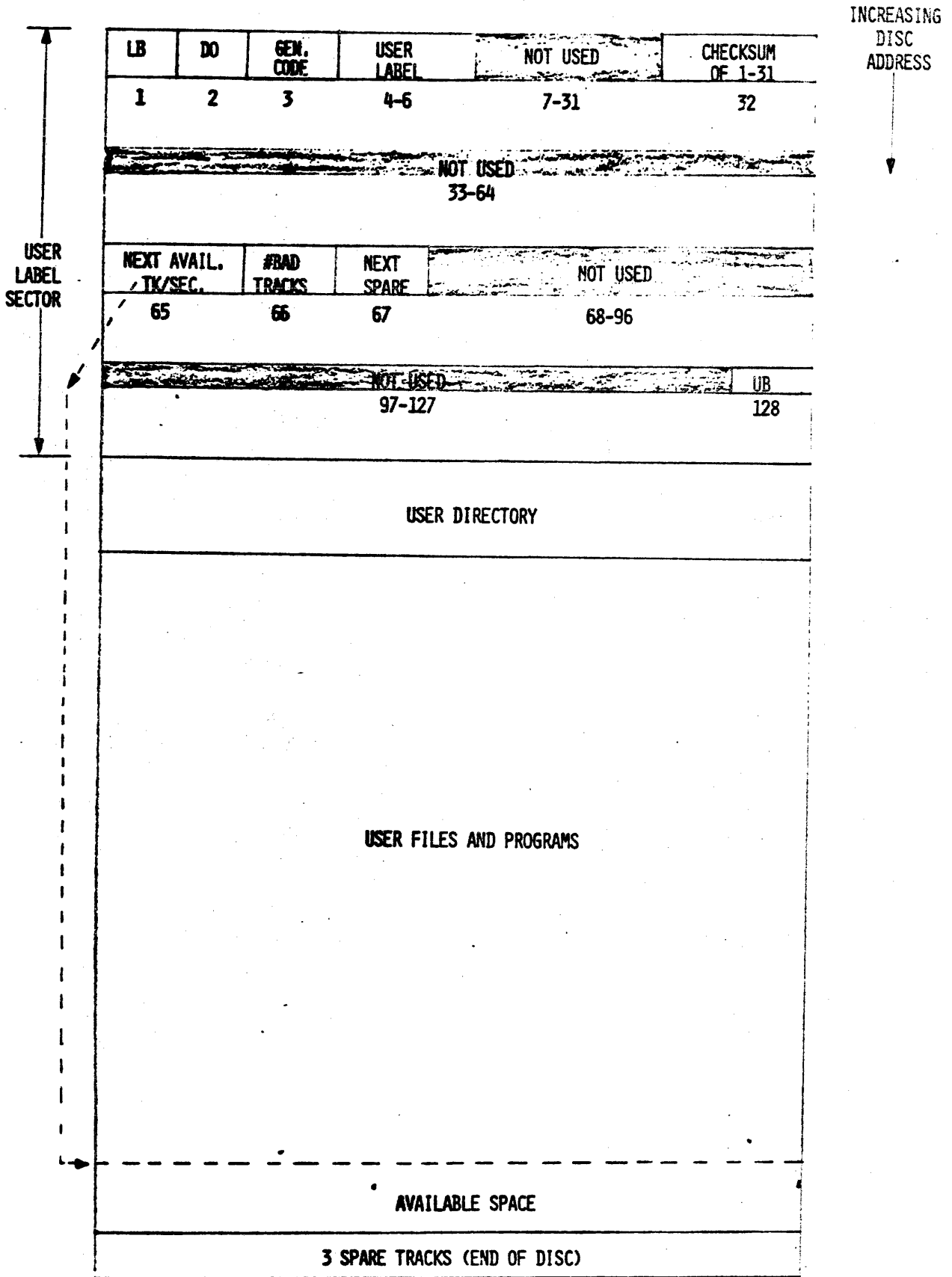

SYSTEM STARTUP (PART 1)
(EXECUTION OF CONFIGURED BOOTSTRAP)

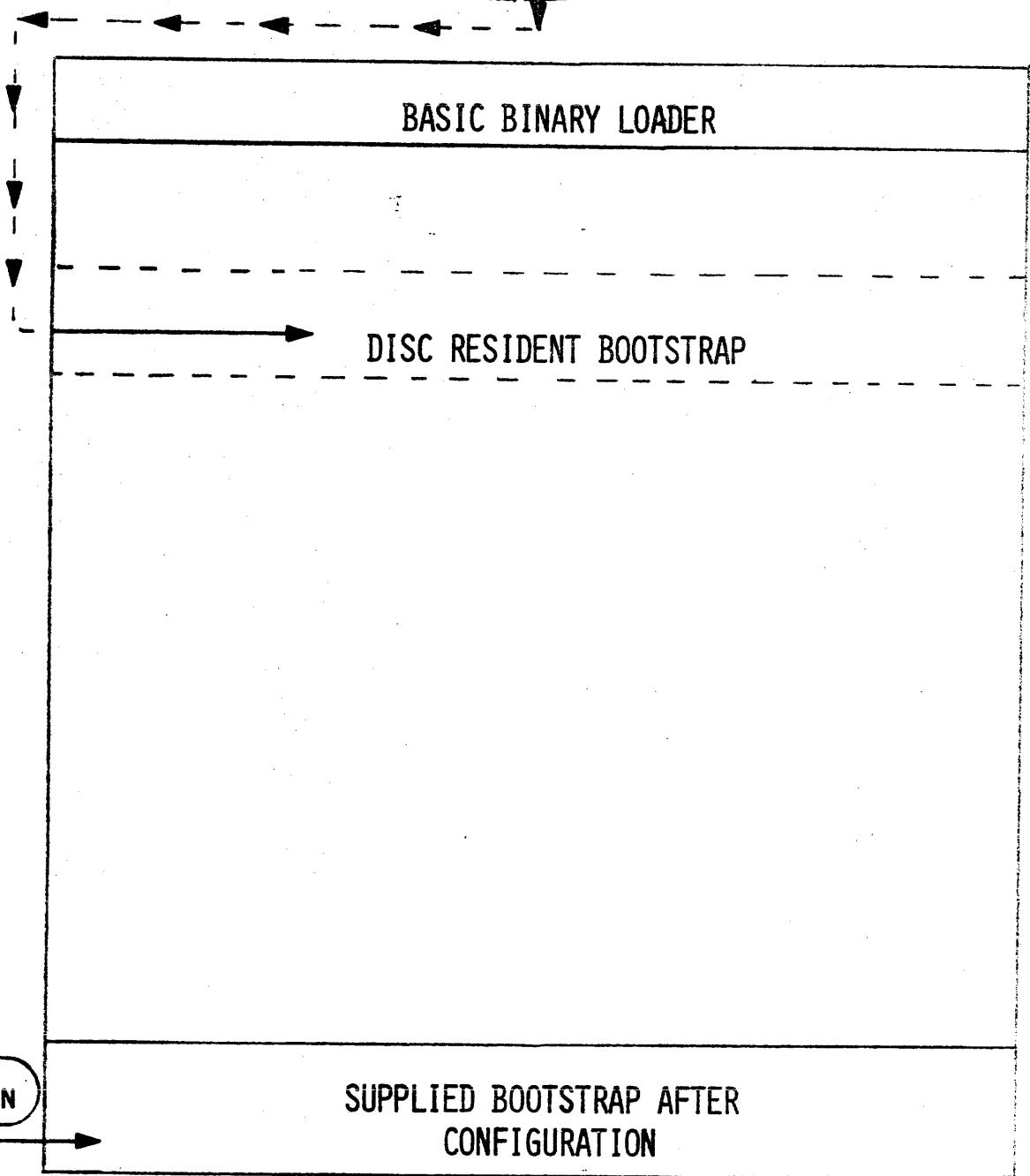
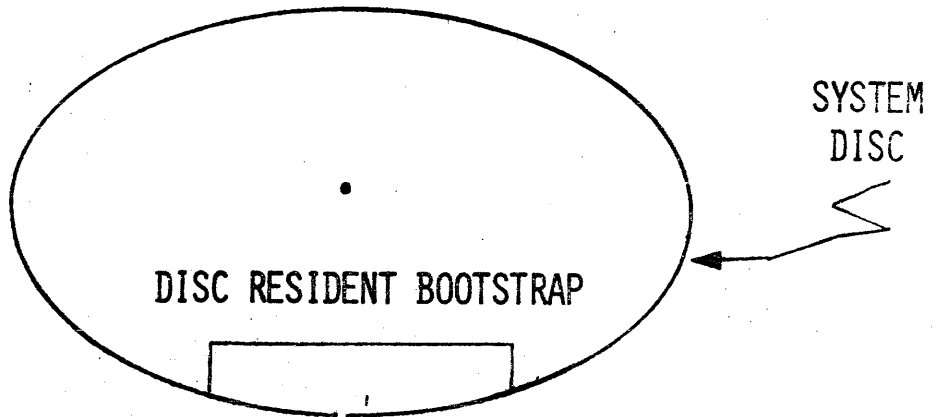

SYSTEM STARTUP (PART 2)
 (EXECUTION OF DISC RESIDENT BOOTSTRAP)

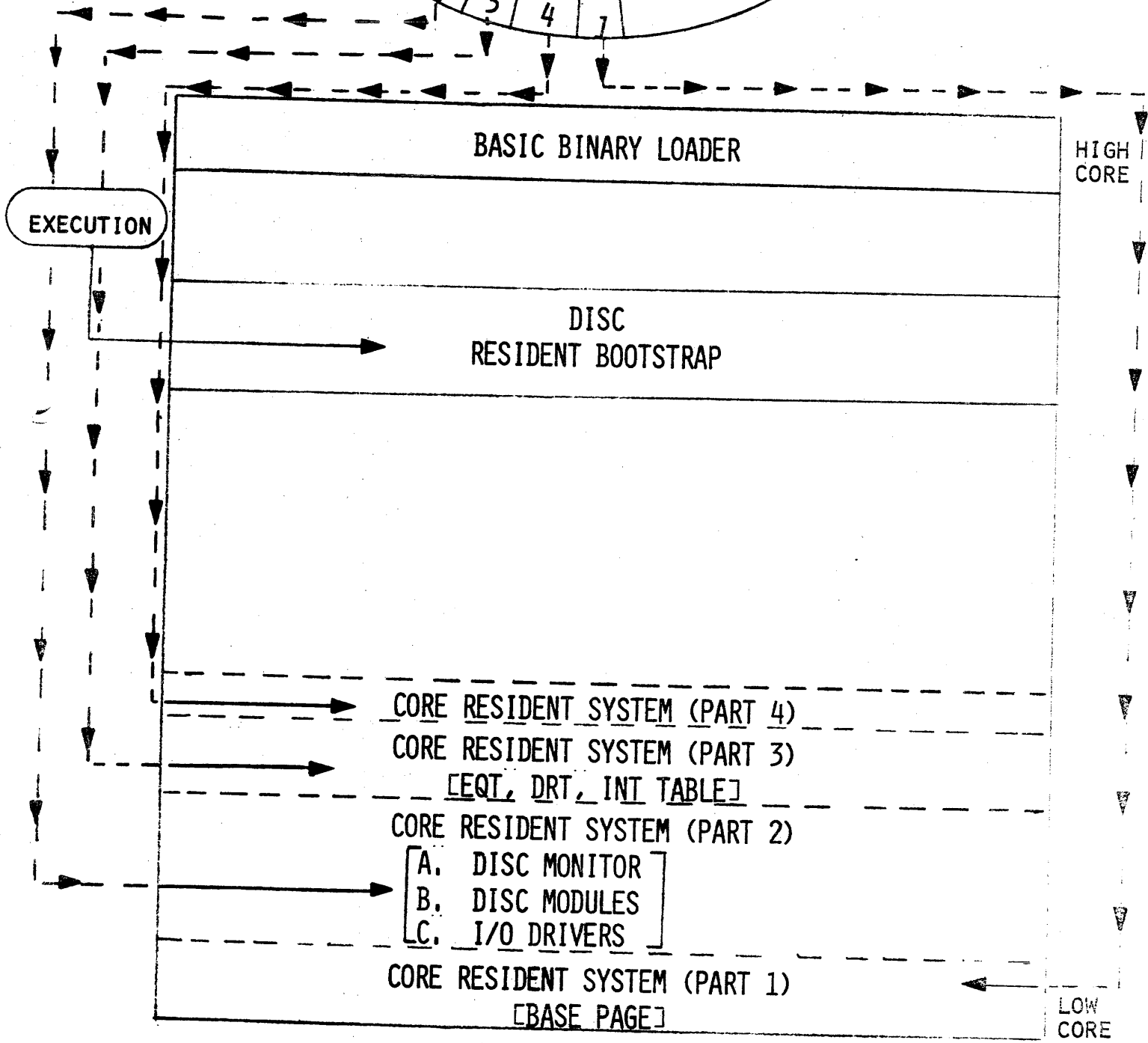
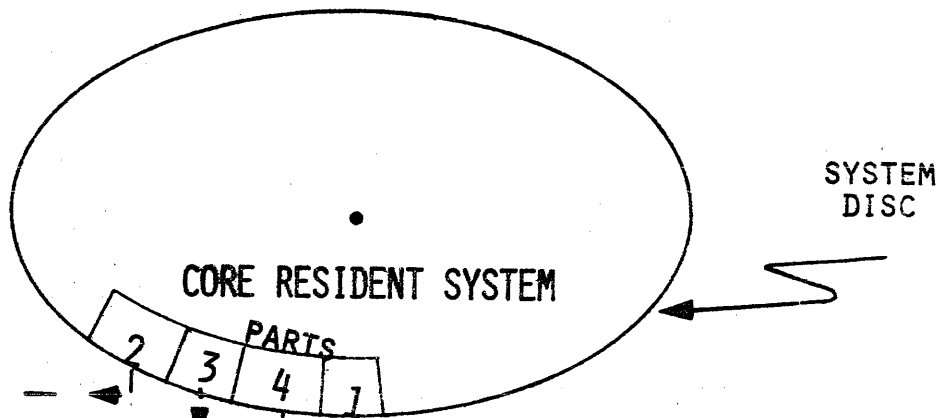

SYSTEM STARTUP (PART 3)
(DISC MONITOR FIRST ENTRY)

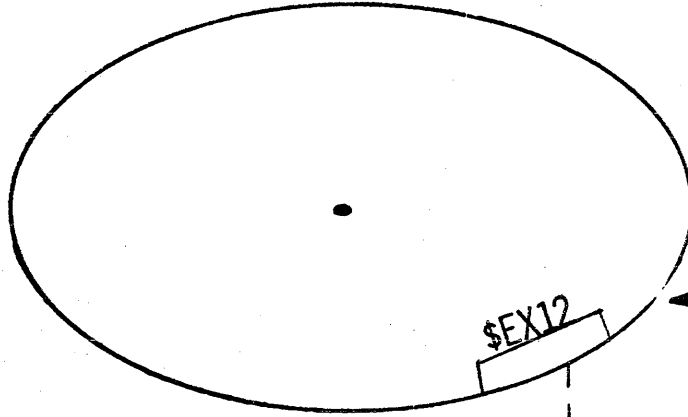

SYSTEM DISC

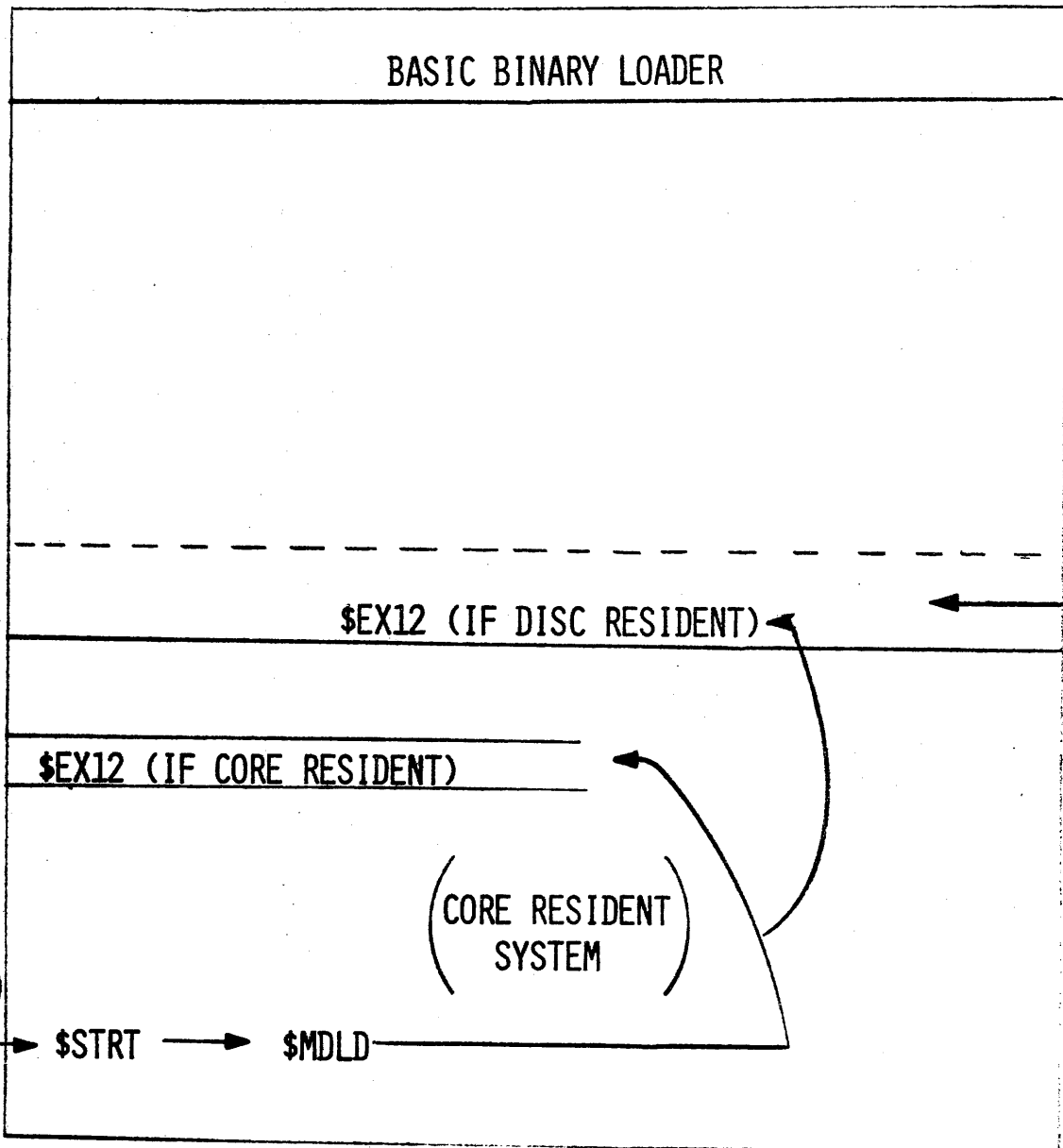

HIGH CORE

EXEC
MODULE
OVERLAY
AREA

EXECUTE

\$STRT

\$MDLD

(CORE RESIDENT
SYSTEM)

LOW CORE

SYSTEM STARTUP (PART 4)
(EXECUTION OF \$EX12 EXEC MODULE)

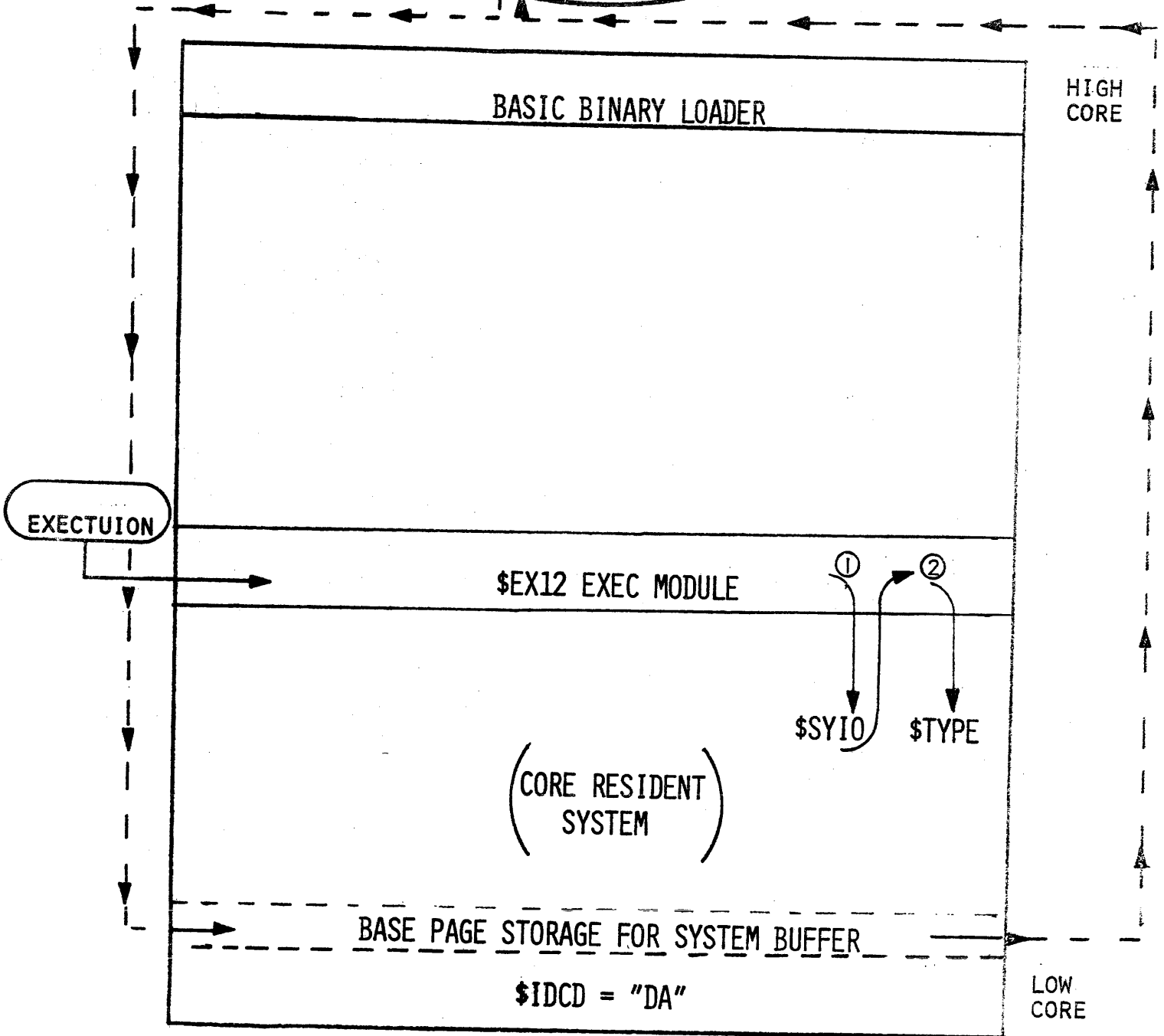
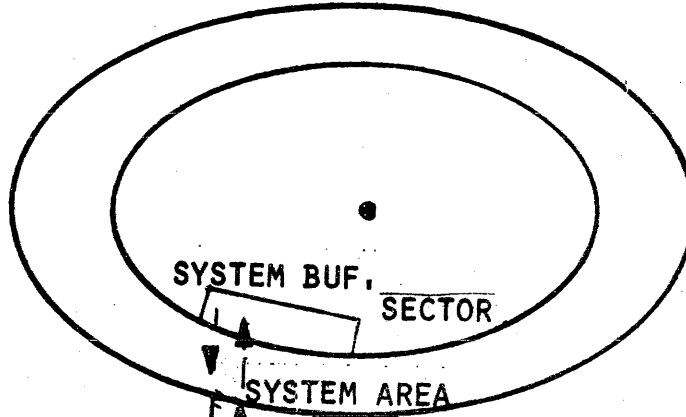

SYSTEM STARTUP (PART 5)
 (EXECUTION OF \$TYPE FOR ":DATE" INPUT)

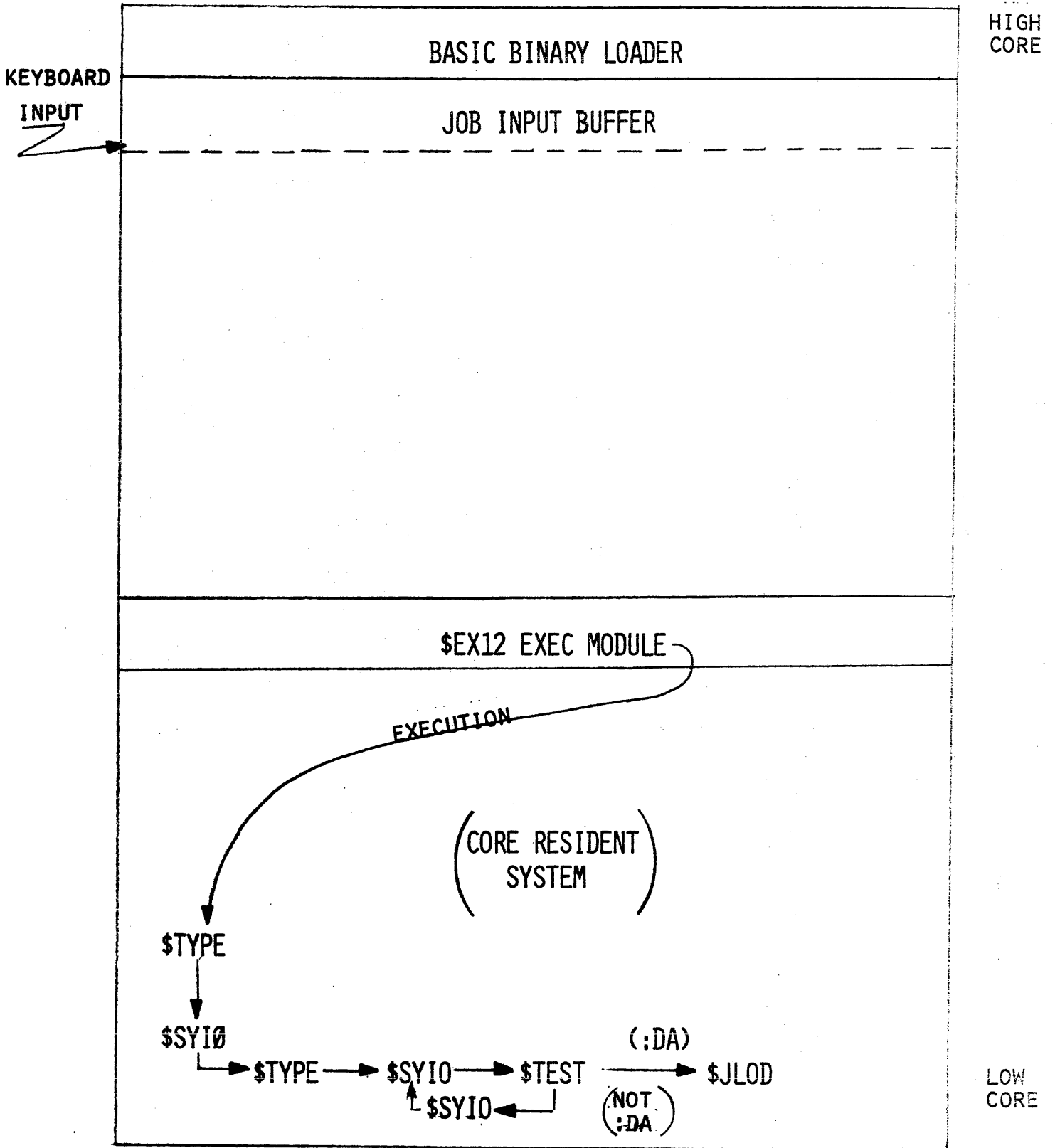

SYSTEM STARTUP (PART 6)
(EXECUTION OF \$JLOD TO LOAD JOB PROCESSOR)

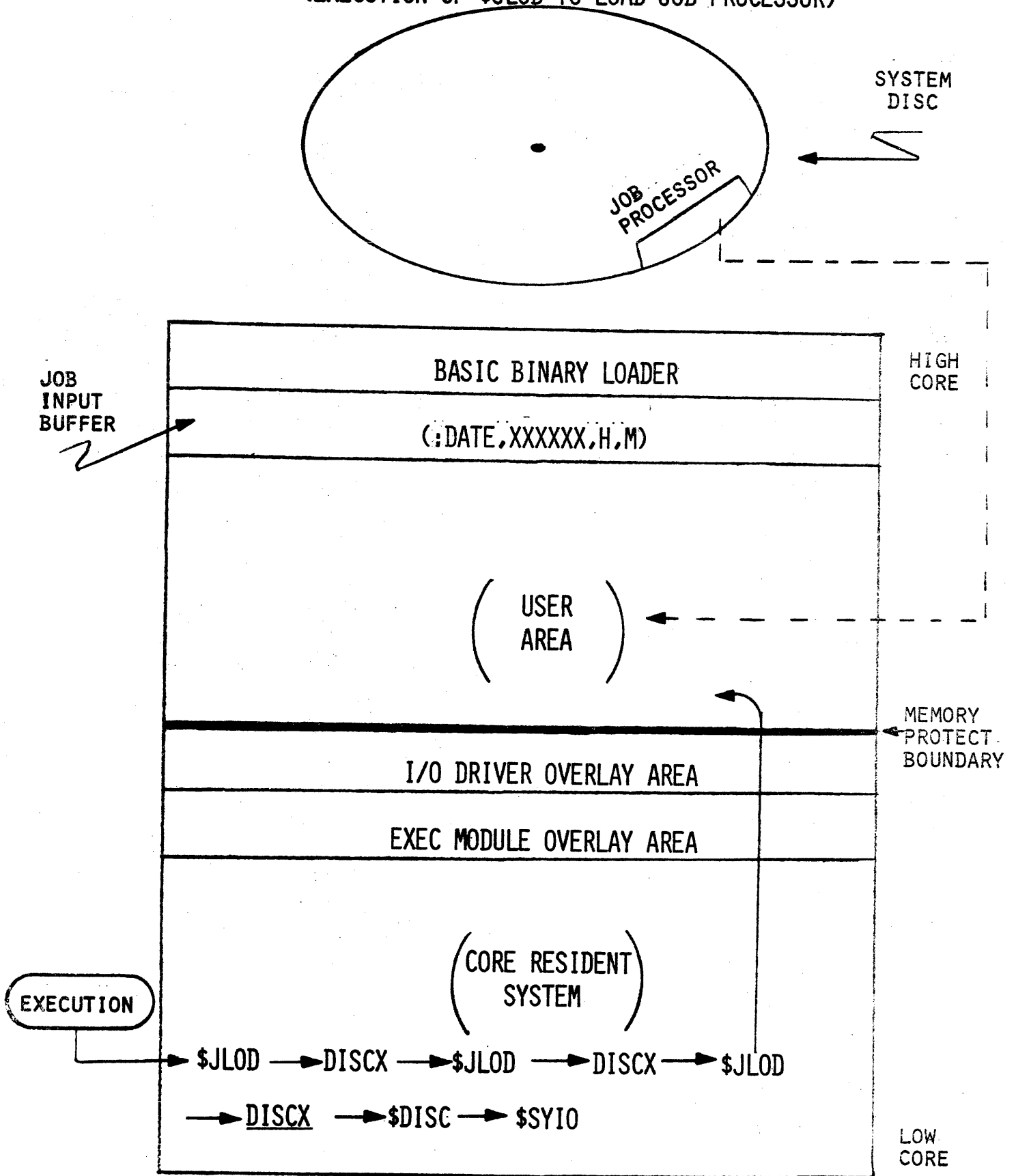

SYSTEM STARTUP (PART 7)
 (EXECUTION OF JOBPR TO UPDATE SYSTEM BUFFER SECTOR)

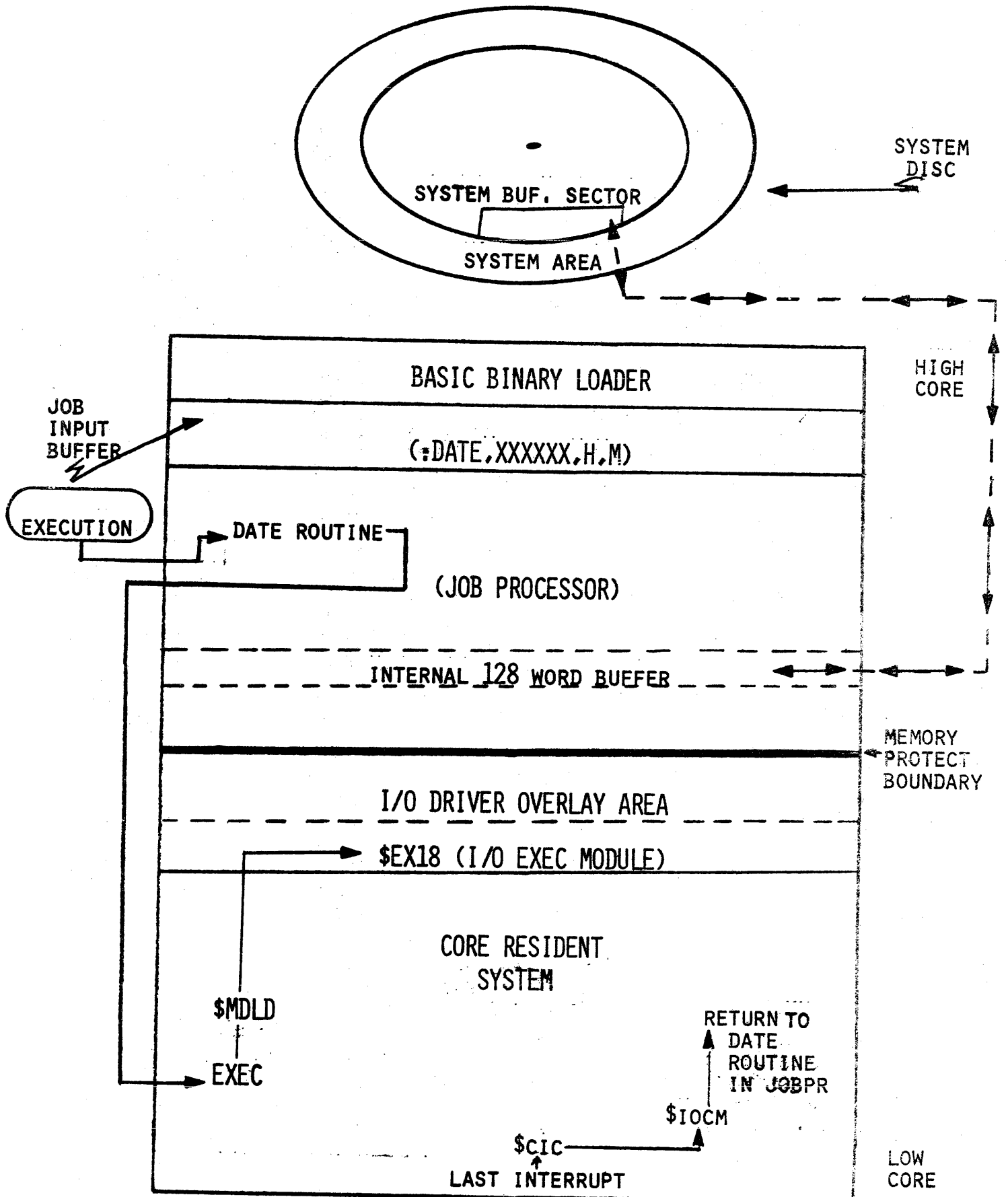

SYSTEM STARTUP (PART 8)
 (REPORTING OF DEFAULT USER DISC SUBCHANNEL AND LABEL)

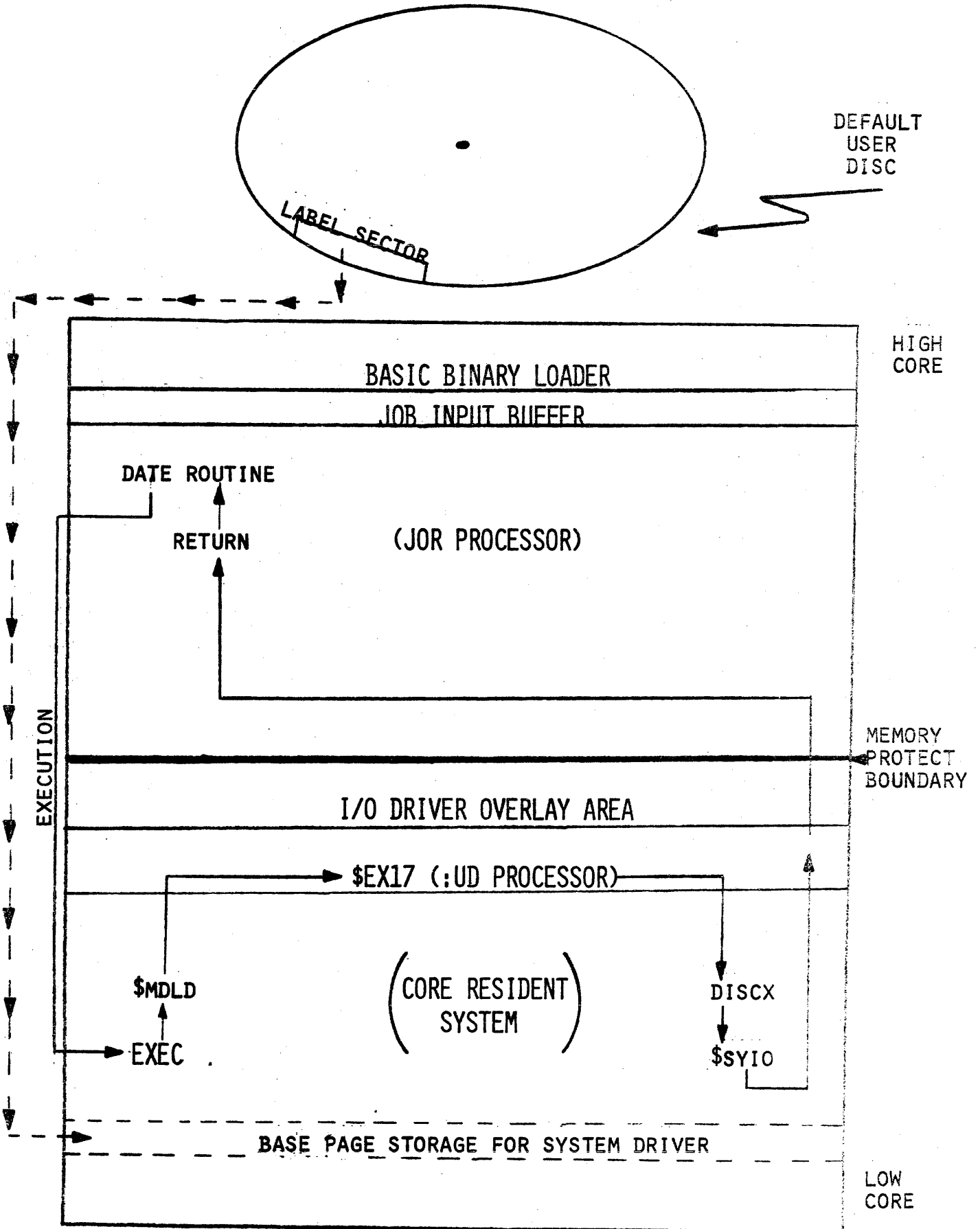

BOOTSTRAPPING DOSM UP FROM DISC

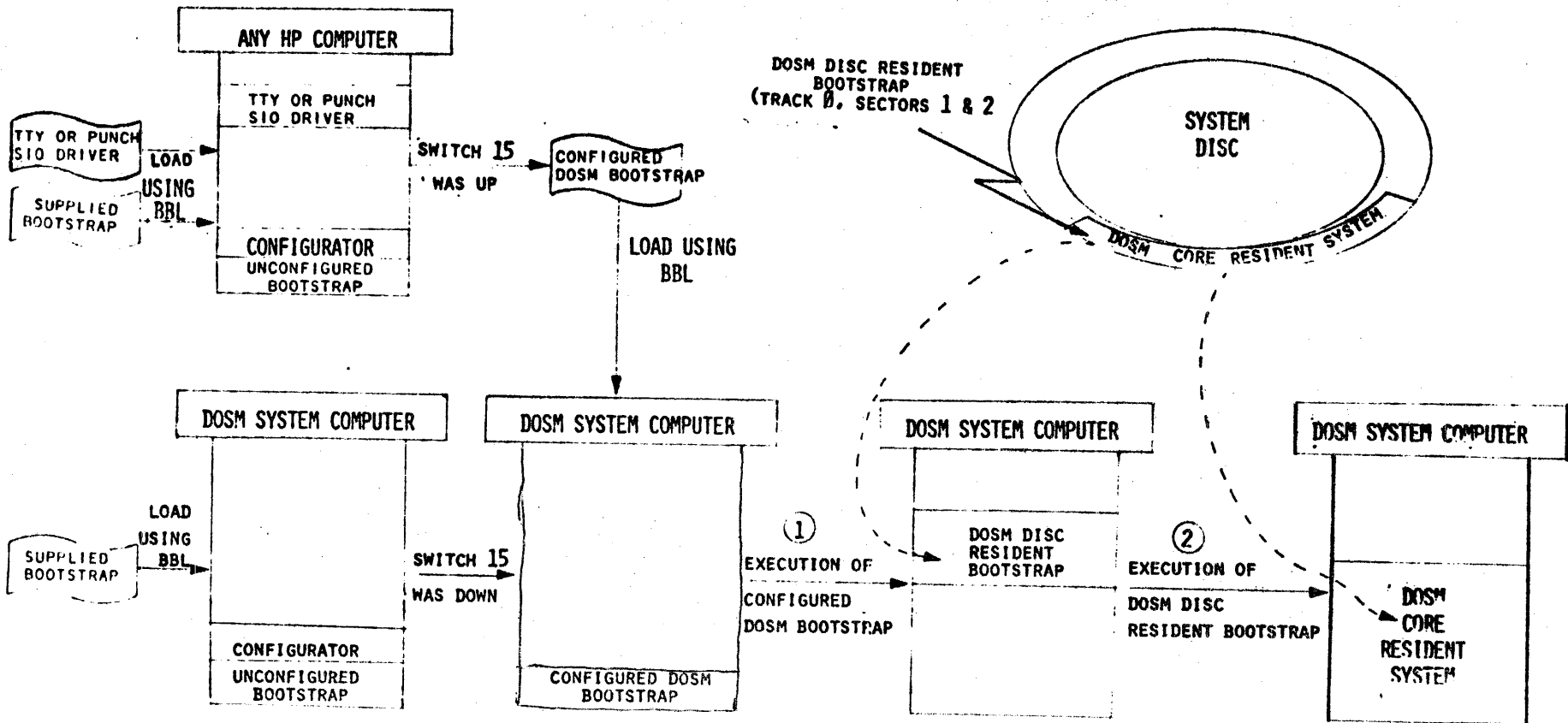

DOSM SYSTEM START-UP

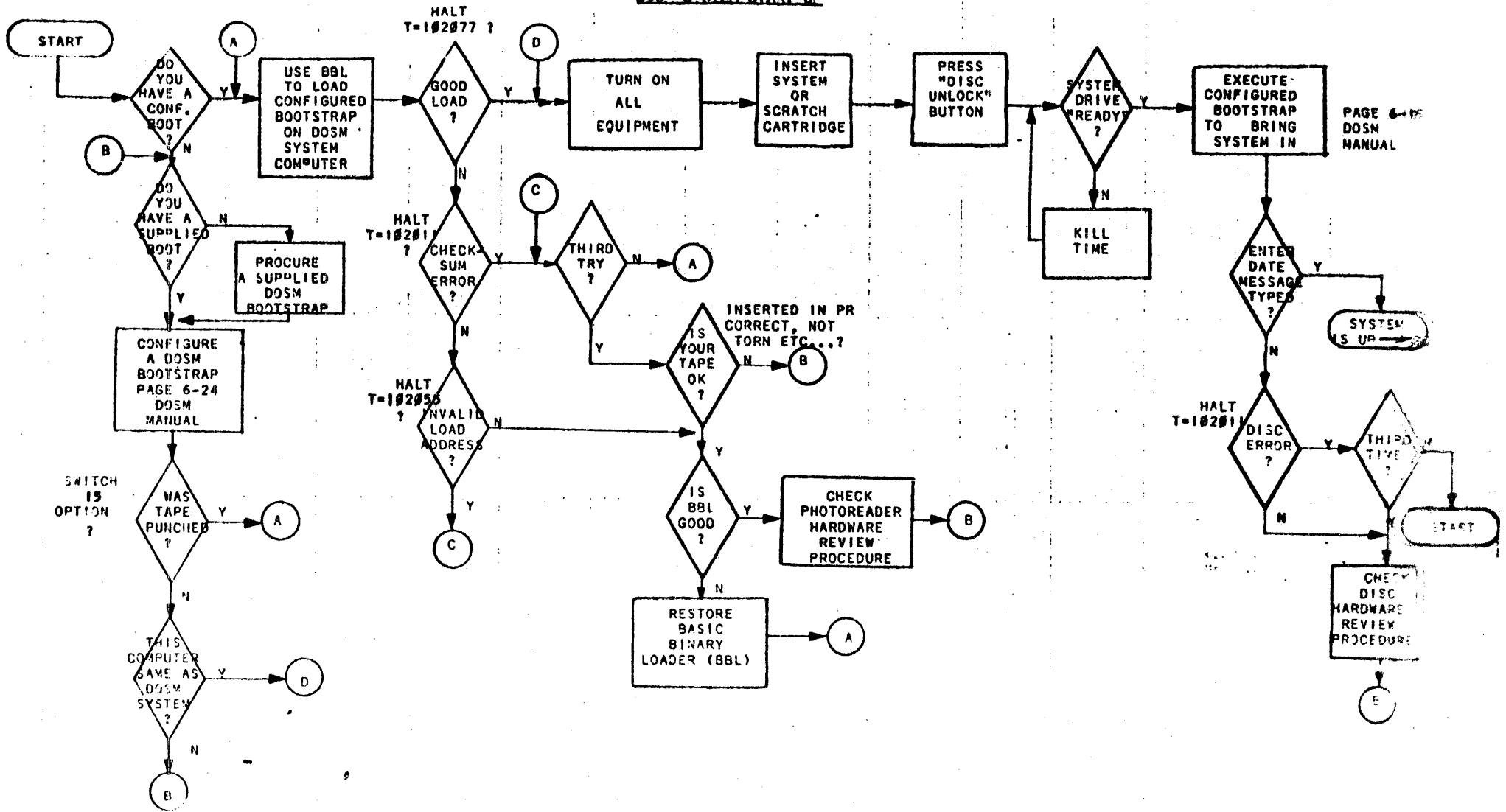

PAGE 6-15
DOSM MANUAL

OFF DIRECTIVE

PURPOSE: TO ABORT CURRENTLY EXECUTING USER PROGRAM OF SYSTEM OPERATION WITHOUT TERMINATING THE JOB.

FORMAT: :OFF

- NOTES:
1. RETURNS SYSTEM TO KEYBOARD MODE.
 2. CAN BE USED TO TERMINATE UNDESIREED LISTS, EDITS, DISC-TO-DISC DUMPS, PROGRAM LOOPS, LOADER OPERATIONS, ASSEMBLIES, AND COMPILATIONS.
 3. CANCELS ANY :DD, :AD, OR :PD DIRECTIVES, UNLESS A PROGRAM IS RUNNING, IN WHICH CASE A PENDING :AD IS EXECUTED.
 4. MUST NEVER BE GIVEN DURING A PURGE (:PURGE DIRECTIVE) OR FOLLOWING /E IN AN EDIT LIST.

INITIALIZE DIRECTIVE

PURPOSE: TO LABEL OR UNLABEL THE CURRENT USER DISC.

FORMAT: :IN,LABEL

WHERE THE LABEL IS A SIX-CHARACTER NAME TO BE WRITTEN IN WORDS 4-6 OF THE LABEL SECTOR ON THE CURRENT USER DISC. A "*" IS ENTERED TO UNLABEL THE DISC. THE FIRST LETTER OF LABEL MUST NOT BE "CONTROL@".

NOTES:

1. IF THE CURRENT USER DISC IS ALREADY LABELED, DOSM PRINTS THE FOLLOWING MESSAGE:

{ TSB }
{ DOS } LABEL XXXXXX (WHERE XXXXXX IS
{ ??? } EXISTING LABEL)

OK TO PURGE?

THE OPERATOR THEN ANSWERS "YES" OR "NO".

2. :IN,* EXECUTION PURGES ALL FILES ON THE CURRENT USER DISC AS FOLLOWS BELOW:

- A. LABEL PRESENCE CODE SET = 0.
- B. FIRST AVAILABLE TK/SEC SET TO START OF USER AREA (IF USER DISC) OR START OF SYSTEM DIRECTORY TRACK +1 (IF SYSTEM DISC).
- C. SETS FIRST WORD IN DIRECTORY = 0 TO INDICATE END-OF-DIRECTORY.
- D. * SET IN FIRST CHARACTER OF LABEL FIELD.
- E. SETS SYSTEM GENERATION CODE AND PROPRIETARY CODE = TO THAT ON SYSTEM LABEL SECTOR.
- F. GENERATES NEW CHECKSUM.

INITIALIZE DIRECTIVE - NOTES CONTINUED:

3. :IN,NEWLB PURGES UNPROTECTED SYSTEM AND MOVES ANY USER FILES DOWN TO LOW DISC IF THE CURRENT USER DISC IS LABELED "SYSTEM" AND IS NOT HARDWARE PROTECTED (I.E., IT WAS CREATED WITH :DD,X DIRECTIVE).
4. SYSTEM GENERATION CODE AND SYSTEM PROPRIETARY CODE ARE SET EQUAL TO THOSE IN THE CURRENT SYSTEM.

CHANGE USER DISC DIRECTIVE (PART 1)

PURPOSE: TO CHANGE SUBCHANNEL ASSIGNMENT FOR THE CURRENT USER DISC.

FORMAT: :UD [, [LABEL] [,N]]
WHERE LABEL IS A SIX-CHARACTER LABEL OR
*IF UNLABELED DISC.
AND N IS THE SUBCHANNEL NUMBER.

- NOTES:
1. SIX BASIC FORMS ARE POSSIBLE (PART 2).
 2. IF THE DISC ON SUBCHANNEL #N HAS A SYSTEM PROPRIETARY CODE NOT EQUAL TO "DO", THE ASSIGNMENT IS STILL MADE AND THE SYSTEM PRINTS THE FOLLOWING:
$$\left. \begin{array}{l} \text{TSB} \\ \text{???} \end{array} \right\} \text{ DISC}$$
 3. IF THE DISC ON SUBCHANNEL #N HAS A SYSTEM GENERATION CODE NOT EQUAL TO THAT OF THE CURRENT SYSTEM, THE ASSIGNMENT IS STILL MADE AND THE SYSTEM PRINTS THE FOLLOWING:
DISC GEN CODE XXXX NOT SYS GEN CODE YYYY ERR POSS
 4. USER DISC SUBCHANNEL ASSIGNMENTS MADE BY THIS DIRECTIVE ARE ONLY TEMPORARY; THE USER DISC SUBCHANNEL ASSIGNMENT IS RESET TO THAT SPECIFIED DURING SYSTEM GENERATION AT THE END OF EACH JOB.
 5. USED IMMEDIATELY FOLLOWING :DD (DISC DUMP) DIRECTIVE TO SPECIFY DESTINATION DISC.

CHANGE USER DISC DIRECTIVE (PART 2)

EXAMPLE	ACTION
:UD (WITHOUT LABEL OR SUBCHANNEL)	INTERROGATES THE CURRENT USER DISC SUBCHANNEL AND PRINTS ITS LABEL ON THE SYSTEM TELEPRINTER: SUBCHAN = n LBL = label (or UNLBL)
:UD,,n (NO LABEL)	IF n IS LABELED, DOS-M PRINTS: LBL = label (OR UNLBL) NO ASSIGNMENT IS MADE.
:UD,label (NO SUBCHANNEL)	DOS-M SEARCHES FOR THE label, STARTING WITH THE HIGHEST NUMBER SUBCHANNEL (DETERMINED AT SYSTEM GENERATION). IF label IS FOUND, DOS-M MAKES IT THE USER DISC AND PRINTS: SUBCHAN = n IF label IS NOT FOUND, DOS-M PRINTS: DISC NOT ON SYS
:UD,label,n	IF n IS LABELED WITH THE SPECIFIED label, DOS-M ASSIGNS n AS THE USER DISC. IF n IS UNLABELED OR HAS A DIFFERENT label, DOS-M PRINTS: LBL = label (OR UNLBL) OPERATOR CAN THEN REISSUE :UD,label,n WITH THE CORRECT LABEL.
:UD*,n	IF n IS UNLABELED, DOS-M ASSIGNS n AS THE USER DISC. IF n IS LABELED, DOS-M MAKES NO ASSIGNMENT AND PRINTS: LBL = label
:UD,*	ASSIGNS THE HIGHEST NUMBER UNLABELED DISC AS THE USER DISC AND PRINTS: SUBCHAN = n IF THERE ARE NO UNLABELED DISC, DOS-M PRINTS: DISC NOT ON SYS

DISC-TO-DISC DUMP DIRECTIVE

PURPOSE:

To DUMP ONTO ANOTHER SUBCHANNEL

1. AN ENTIRE DISC USING :DD
2. THE SYSTEM AREA (INCLUDING SYSTEM BUFFER) USING :DD,X.
3. ALL OR SPECIFIED FILES OF THE USER AREA (OPTIONALLY ASSIGNING SOME NEW FILE NAMES) USING

:DD,U[,FILE 1 [(FILE A)],FILE 2[(FILE B)],...,]

WHERE X SPECIFIES THE SYSTEM AREA

U SPECIFIES THE USER AREA

FILE 1, FILE 2, ..., SPECIFY THE FILES TO BE DUMPED

FILE A, FILE B, ..., SPECIFY THE OPTIONAL NEW NAMES FOR FILE 1, FILE 2, ...

NOTES:

- A. RENAMED FILES MAY BE INTERMIXED WITH UNCHANGED FILES IN 3, ABOVE.
- B. THE DESTINATION DISC MUST BE SPECIFIED BY THE :UD DIRECTIVE IMMEDIATELY FOLLOWING THE :DD DIRECTIVE. FOR :DD,:DD,X THE FOLLOWING :UD DIRECTIVE MUST BE :UD*,n WHERE n IS NOT THE SYSTEM DISC.
- C. WHEN THE DESTINATION DISC FOR A :DD,U IS A SYSTEM DISC (OTHER THAN CURRENT SYSTEM), THE USER FILES ARE DUMPED IN THE USER AREA FOLLOWING THE SYSTEM FILES.
- D. IF FILES OF THE SOURCE DISC WILL NOT COMPLETELY FIT ON THE DESTINATION DISC, THE SYSTEM WILL TRANSFER AS MANY WHOLE FILES AS POSSIBLE AND PRINT: TRAC # TOO BIG.

SYSTEM SEARCH DIRECTIVE (PART 1)

PURPOSE:

TO SPECIFY A LIST OF DISC SUBCHANNELS TO BE SEARCHED BY SYSTEM FOR FILE NAMES OTHER THAN THE CURRENT USER DISC.

FORMATS:

:SS

ALL ACTIVE SUBCHANNELS ARE SEARCHED IN THE FOLLOWING ORDER:

1. CURRENT USER DISC SUBCHANNEL
2. HIGHEST ACTIVE SUBCHANNEL IN SYSTEM
3. NEXT HIGHEST ACTIVE SUBCHANNEL IN SYSTEM
- .
- .
- .
- .
- .
- LOWEST ACTIVE SUBCHANNEL IN SYSTEM

:SS,N1,N2,N3,....

ALL ACTIVE SUBCHANNELS (WITHIN N1,N2,N3,....LIST) ARE SEARCHED IN THE FOLLOWING ORDER:

1. CURRENT USER DISC SUBCHANNEL
2. LOWEST NUMBERED ACTIVE SUBCHANNEL SPECIFIED IN N1,N2,N3,....LIST.
3. NEXT LOWEST NUMBERED ACTIVE SUBCHANNEL SPECIFIED IN N1,N2,N3,....LIST.
- .
- .
- .
- .
- .
- HIGHEST NUMBERED ACTIVE SUBCHANNEL SPECIFIED IN N1,N2,N3,....LIST.

:SS,99

ONLY THE CURRENT USER DISC SUBCHANNEL IS SEARCHED. THIS IS THE DEFAULT CONDITION. EVERY JOB STARTS OUT IN THIS CONDITION.

SYSTEM SEARCH DIRECTIVE (PART 2)

NOTES:

1. THIS IS AN OPTIONAL DIRECTIVE VALID ONLY IF "YES" WAS RESPONSE TO ALLOW :SS? QUESTION DURING SYSTEM GENERATION.
2. THE :SS CONDITION SET APPLIES TO ALL EXEC CALLS AND DIRECTIVES THAT REQUIRE A FILE SEARCH.
3. CURRENT USER DISC SUBCHANNEL NUMBER IS CHANGED TO THE SUBCHANNEL CONTAINING THE FILE THAT INITIATED THE FILE SEARCH. THIS IS REPORTED BY SYSTEM EACH TIME IT CHANGES WITH TTY PRINTOUT, SUBCHAN = n IF THE JOB PROCESSOR IS IN CORE (I.E. NO OTHER USER PROGRAM EXECUTING).
4. IF SEARCH DOES NOT FIND THE DESIRED FILE, THE CURRENT USER DISC SUBCHANNEL NUMBER IS RESTORED TO ITS VALUE BEFORE SEARCH.
5. IF SEARCH IS INTERRUPTED BEFORE COMPLETION, THE CURRENT USER DISC SUBCHANNEL NUMBER WILL BE ON WHATEVER SUBCHANNEL NUMBER THE SYSTEM WAS SEARCHING WHEN INTERRUPTION OCCURRED.
6. :LIST,U DIRECTIVE DOES NOT STOP ON DUPLICATE FILE NAMES, BUT CONTINUES SEARCHING AND PRINTING USER DIRECTORY. AT COMPLETION, THE CURRENT USER DISC SUBCHANNEL IS RESTORED TO NUMBER BEFORE THIS DIRECTIVE ENTERED.
7. MORE THAN ONE :SS CONDITION MAY BE SET DURING A JOB. EACH ONE SET REMAINS IN EFFECT UNTIL A NEW ONE IS ENTERED OR THE JOB IS ENDED.
8. :SS CONDITIONS SET ARE NOT FOLLOWED BY RELOCATING LOADER (LOADR) OR TO DISC DUMPS INITIATED BY :DD DIRECTIVE.

INPUT : DATE,XXXXXXXXXX,H,M ← Brought up System from TTY

→ @:DA,19.OCT.70,14,0
SUBCHAN=1
LBL=000000 } ← System reports default User Disc Subchannel #
@ 2nd Label

→ :JOB,EXMP1
JOB EXMP1 19.OCT.70 TIME=0840 MIN. 13.4 SECS.
@

→ :UD
SUBCHAN=1
LBL=000000
@

→ :DD ← Declared entire Disc to Disc dump

→ :OFF ← Changed mind - bailed out of DD condition

→ :DD,X ← Declared System Area Only Disc dump

→ :UD,*,0 ← Declared Fixed Disc as destination disc

LBL=SYSTEM
DISC GEN CODE 1013 NOT SYS GEN CODE 9000 ERR POSS
RE-ENTER STATEMENT ON TTY.
@

→ :UD
MISSING PARAMETER
RE-ENTER STATEMENT ON TTY. } ← System still waiting for
Destination Disc

→ :OFF ← Bailed out of DD,X condition

→ :UD
SUBCHAN=1
LBL=000000
@

→ :UD,SYSTEM,0 ← Changed Current User Disc to Fixed Disc

DISC GEN CODE 1013 NOT SYS GEN CODE 9000 ERR POSS
@

→ :UD ← Checked to see if assignment was made

SUBCHAN=0
LBL=SYSTEM
DISC GEN CODE 1013 NOT SYS GEN CODE 9000 ERR POSS } YES!

→ :IN,* ← Entry to unlabel the Fixed Disc
DOS LABEL SYSTEM
OK TO PURGE?

→ YES ← Told system to purge "system" label, Gen. Code

→ :UD
SUBCHAN=0 } ← Now System has unlabelled Fixed Disc
UNLBL
@

Reassign USER DISC

:UD,QQQQQ,1

→ :UD ← Checked to make sure assignment made
SUBCHAN=1
LBL=QQQQQ

→ :DD,X ← Declared System area only Disc dump

→ :UD,*,0 ← Declared Destination Disc

→ :UD
SUBCHAN=0
LBL=SYSTEM

→ :UD,,0 ← checked Label on Subchannel # 0 (Fixed Disc)
LBL=SYSTEM

→ :UD
SUBCHAN=0
LBL=SYSTEM

→ :LI,U ← Incorrect Statement Entered
MISSING PARAMETER
RE-ENTER STATEMENT ON TTY.

→ :LI,U,1 ← List User Directory
NAME TYPE SCTRS DISC ORG PROG LIMITS B.P. LIMITS ENTRY LIBR. P-BIT
SUBCHAN=0
NOTHING ON Fixed Disc to be listed

→ :SS ← Set System Search for all active subchannels

→ :LI,U,1
NAME TYPE SCTRS DISC ORG PROG LIMITS B.P. LIMITS ENTRY LIBR. P-BIT
SUBCHAN=0
SUBCHAN=1
XREF UM 0013 T023 000 12000 14750 01002 01036 12000 14071
QT1 SS 0001 T023 013
WEOT UM 0002 T023 014 12000 12013 01002 01003 12000 12013

→ *:OFF ← Bailed out of long listing

→ :SS,99 ← Reset default System Search

→ :LI,U,1 ← List User Directory
NAME TYPE SCTRS DISC ORG PROG LIMITS B.P. LIMITS ENTRY LIBR. P-BIT
SUBCHAN=1
XREF UM 0013 T023 000 12000 14750 01002 01036 12000 14071

→ *:OFF ← Bailed out

→ :UD
SUBCHAN=1
LBL=QQQQQ } ← Note how Current user Disc is still 1

→ :UD
SUBCHAN=1
LBL=00000

→ :DD,U ← Declared User Area only Disc Dump

→ :UD, SYSTEM, 0 ← Destination Disc

XREF
EOT1
WEOT
XREFR
DISCM
EXECS
DVR05
DVR31
LIBRY
DVR02
DVR01
DVR22
LODR
JOBP
ASMBL
ASMD
ASM3
ASM4
ASM5
FRTN
FTN1
FTN2
FTN3
FTN4
ASM1
ASM2
SI01
BASC1
BOOT
FTNH
EOF
FSPACE
RWIND
D.00S
TSRTS
TSRTR
CLEAR

System Reported Each User File Name
Transferred as transfer done

→ :UD
SUBCHAN=0
LBL=SYSTEM

→ :LI,U,1 ← List user Directory

NAME	TYPE	SCTRS	DISC	ORG	PROG	LIMITS	B.P.	LIMITS	ENTRY	LIBR.	P-BIT
XREF	UM	0013	T024	000	12000	14750	01002	01036	12000	14071	
EOT1	SS	0001	T024	013							
WEOT	UM	0002	T024	014	12000	12013	01002	01003	12000	12013	

*:ABORT ← Bailed out and aborted
JOB ABORTED!

END JOB EXMP1 RUN=0011 MIN. 52.2 SEC. EXEC=0000 MIN. 00.0 SEC.

OPERATIONAL DIFFERENCE SUMMARY (PART 1)

CONDITION	DOS	DOSM
SYSTEM START-UP	Outputs the following: INPUT FR = FRESH; CO = CONTINUATION	Does not output this message. Outputs INPUT :DATE,XXXXXXXX,H,M (H and M are omitted if system does not have Time Base Generation)
:OFF Directive	Does not exist. Must use :ABORT to terminate the current job.	New Directive to abort without terminating current job.
:DD Directive	Does not exist. SDUMP program must be used to create backup copies on Mag. Tape	New Directive to perform disc to disc dumps. Backup copy may be put on cartridge disc.
:SS Directive	Does not exist.	New Directive to enable multi-disc file searching.
:IN Directive	Does not exist. Discs are not labeled.	New Directive to label or unlabeled discs.
:UD Directive	Does not exist.	New Directive to change current user disc.
System Recognition of Operator Attention by outputting *	Following are valid entries at this time: :ABORT, :DN, :EQ, :LU, :TYPE, :UP	Following are valid entries at this time: :OFF, :PAUSE, :ABORT, :DN, :EQ, :LU, :TYPE, :UP
:JOB Directive	Current time is always printed on the System Teleprinter and List device along with the job name and date. TBG is System requirement.	Current Time is only printed on the system Teleprinter and list device when Time Base Generator is in system. TBG is an option.

OPERATIONAL DIFFERENCE SUMMARY (PART 2)

CONDITION	DOS	DOSM
:EJOB Directive	Not Applicable	System resets :SS condition to be only standard user disc.
	System condenses User file. Only one User File Area.	System condenses all user discs following :SS condition.
	Not Applicable	User Disc subchannel assignment reset to standard subchannel # unless standard is "NOT READY" or new cartridge has been inserted with different label.
	Message is printed on System Teleprinter and standard List device with job name, execution and run times. TBG is a System Requirement.	Execution and Run times are not printed if the Time Base Generator is not in the system. TBG is optional.
:PROG Directive	Not Applicable Only one user area in system.	File Search for program specified follows :SS condition. User files are searched first, then system files.
:RUN Directive	Optional "time parameter" always used. TBG is System requirement.	"Time parameter" is ignored if Time Base Generator is not in system. TBG is optional.
	Not Applicable. Only one user area in system.	File search for <u>User</u> program follows :SS condition.

OPERATIONAL DIFFERENCE SUMMARY (PART 3)

CONDITION	DOS	DOSM
:TRACKS DIRECTIVE	REQUIRES THAT THE OPERATOR INFORM SYSTEM OF THE FAULTY TRACKS ON A FRESH START-UP FOLLOWING THE DATE DIRECTIVE.	DOES NOT INCLUDE THIS OPTION BECAUSE A RECORD IS MAINTAINED IN THE LABEL SECTOR ON EACH DISC FOR NUMBER OF FAULTY TRACKS, THE ADDRESS OF NEXT SPARE TRACK, ETC...
	REPORTS TRACK NUMBERS THAT ARE FAULTY.	REPORTS TOTAL NUMBER OF TRACKS THAT HAVE BEEN REPLACED BY SPARES.
:STORE DIRECTIVE	CHECKS USER AREA FOR DUPLICATE FILE NAMES.	CHECKS ALL ACTIVE SUBCHANNELS (ACCORDING TO :SS CONDITION) FOR DUPLICATE FILE NAME. STORE ACUALLY DONE ON CURRENT USER DISC.
	ONE SECTOR = 64 WORDS	ONE SECTOR = 128 WORDS
:JFILE DIRECTIVE	SOURCE FILE SPECIFIED IS IN ONE USER AREA.	SOURCE FILE SPECIFIED MAY BE ON ANY ACTIVE SUBCHANNEL (ACCORDING TO :SS CONDITION).
:EDIT DIRECTIVE	SOURCE FILE SPECIFIED IS IN ONE USER AREA.	SOURCE FILE SPECIFIED MAY BE ON ANY ACTIVE SUBCHANNEL (ACCORDING TO :SS CONDITION).
	UPDATED OR NEW SOURCE FILE IS STORED IN ONLY ONE USER AREA.	IF NEW FILE NAME IS SPECIFIED, THIS FILE IS STORED ON SAME SUBCHANNEL AS OLD FILE.
:PURGE DIRECTIVE	FILES SPECIFIED ARE ONLY IN ONE USER	FILES SPECIFIED MAY BE ON ANY ACTIVE SUBCHANNEL (ACCORDING TO :SS CONDITION). ALL ASSOCIATED USER DISCS ARE REPACKED FOR EFFICIENCY. USE :IN,* TO PURGE ALL USER FILES ON A GIVEN USER DISC.

OPERATIONAL DIFFERENCE SUMMARY (PART 4)

CONDITION	DOS	DOSM
:LIST DIRECTIVE	DOSE NOT HAVE P-BIT FIELD FOR DIRECTORY LISTINGS.	HAS ALL FIELDS OF DOS WITH ADDITIONAL FIELD, P-BIT. ENTRY UNDER THIS FIELD WILL BE "T" TO INDICATE THAT THE ASSOCIATED FILE IS TEMPORARY AND WILL BE PURGED AT :EJOB IF NOT STORED WITH :STORE.
	USER DIRECTORY IS ONLY ON ONE DISC.	USER DIRECTORY LISTING HAS SUBCHANNEL NUMBERS PRECEDING USER FILES ON THAT SUBCHANNEL.
	NOT APPLICABLE	CURRENT USER DISC SUBCHANNEL NUMBER IS RESTORED FOLLOWING :LIST,U.
	SOURCE FILE SPECIFIED IS ON ONE USER AREA.	SOURCE FILE SPECIFIED MAY BE ON ANY ACTIVE SUBCHANNEL (ACCORDING TO :SS CONDITION).
:DUMP DIRECTIVE	USER FILES ONLY ON ONE DISC.	FILE SPECIFIED MAY BE ON ANY ACTIVE SUBCHANNEL (ACCORDING TO :SS CONDITION)
:SA OR :SO DIRECTIVES	CALLED DISC DUMP	CALLED SECTOR DUMP TO DISTINGUISH FROM :DD (DISC DUMP).
	DUMP IS TO SYSTEM TELEPRINTER (LU # 1)	DUMP IS TO STANDARD LIST DEVICE (LU #6).
	ANY PORTION OF DISC(S) ON SYSTEM MAY BE DUMPED.	DUMP ANY PORTION OF CURRENT USER DISC EVEN IF USER AREA IS ON SYSTEM DISC.
:DATE DIRECTIVE	HOURS AND MINUTES ENTRIES ARE ALWAYS MEANINGFUL. TB6 IS SYSTEM REQUIREMENT	IF TIME BASE GENERATOR IS NOT PRESENT IN SYSTEM, HOURS AND MINUTES ARE SET TO ZERO.

CHANGE USER DISC EXEC CALL

(GENERAL FORMAT)

PURPOSE

TO CHANGE THE SUBCHANNEL ASSIGNMENT FOR THE USER DISC.

ASSEMBLY LANGUAGE

```
EXT EXEC
.
.
.
JSB EXEC                (TRANSFER CONTROL TO DOS-M)
DEF *+3 (OR 4)          (POINT OF RETURN FROM DOS-M)
DEF RCODE                (REQUEST CODE)
DEF LABEL                (DISC LABEL)
DEF SUBCH                (DISC SUBCHANNEL; OPTIONAL)
RETURN POINT
.
.
.
RCODE DEC 23            (REQUEST CODE = 23)
LABEL ASC 3, xxxxxx     (LABEL = xxxxxx)
SUBCH DEC (Ø TO 7)
```

FORTRAN

```
IRCDE = 23
DIMENSION LABEL (3)
LABEL (1) = xx
LABEL (2) = xx
LABEL (3) = xx
ICHNL = M      (Ø THROUGH 7)
CALL EXEC (IRCDE, LABEL, ICHNL)
```

CHANGE USER DISC EXEC CALL -- FORM # 1
(LABEL AND SUBCHANNEL SPECIFIED)

CALLING SEQUENCE:

JSB EXEC
 DEF *+4
 DEF RCODE
 DEF LABEL
 DEF SUBCH
 (RETURN POINT)

TRANSFER CONTROL TO EXEC
 DEFINE RETURN POINT
 DEFINE REQUEST CODE LOCATION
 DEFINE LABEL LOCATION
 DEFINE SUBCHANNEL LOCATION

RCODE DEC 23
 LABEL ASC 3,xxxxxx
 SUBCH DEC N

23 FOR REQUEST CODE
 6 CHARACTER DISC LABEL OR "*" "
 N = 0-7 FOR SUBCHANNEL #

SYSTEM ACTION	OPERATOR ACTION
CHECKS IF SUBCHANNEL N IS LABELED AS SPECIFIED IN CALL (LABEL NAME OR "**")	NONE REQUIRED
<u>MATCH</u> - MAKES ASSIGNMENT AND RETURNS	NONE REQUIRED
<p><u>No MATCH</u> - PRINTS MESSAGE: LBL = (LABEL NAME FOUND ON SUBCHANNEL N) OR UNLBL IF "**" xxxxx SUSP WHERE xxxxx IS NAME OF EXECUTING PROGRAM.</p>	<p>1. <u>IF CORRECTLY LABELED DISC ON HAND:</u> MOUNT IN DRIVE AND "READY" DRIVE, THEN ENTER :GO FOR SYSTEM TO EXECUTE AT START OF EXEC CALL. OR 2. <u>IF NO PROPERLY LABELED DISC ON HAND:</u> <u>HAND:</u> ENTER: :ABORT OR :OFF</p>

~~CHANGE USER DISK EXEC CALL TO EXEC # 4~~

(ONLY LABEL SPECIFIED)

CALLING SEQUENCE:

JSB EXEC
 DEF *+3
 DEF RCODE
 DEF LABEL
 (RETURN POINT)

TRANSFER CONTROL TO EXEC
 DEFINE RETURN POINT
 DEFINE REQUEST CODE LOCATION
 DEFINE LABEL LOCATION

RCODE DEC 23
 LABEL ASC 3,xxxxxx

23 FOR REQUEST CODE
 6 CHARACTER LABEL OR "***"

SYSTEM ACTION	OPERATOR ACTION
SEARCHES FOR LABEL OR "*** DISC STARTING WITH THE HIGHEST SUBCHANNEL NUMBER.	NONE REQUIRED
<u>MATCH</u> - MAKES ASSIGNMENT AND RETURNS	NONE REQUIRED
<u>NO MATCH</u> - PRINTS MESSAGE: DISC NOT ON SYST xxxxx SUSP WHERE xxxxx IS NAME OF EXECUTING PROGRAM.	1. <u>IF PROPERLY LABELED DISC ON HAND:</u> MOUNT IN DRIVE AND "READY" DRIVE. THEN ENTER :GO FOR SYSTEM TO EXECUTE AT START OF EXEC CALL. OR 2. <u>IF NO APPROPRIATELY LABELED DISC ON HAND:</u> ENTER: :ABORT OR :OFF

DOS/DOSM GENERAL PURPOSE EXEC CALLS WITH NEGATIVE REQUEST CODES

REQUEST CODE	FUNCTION	CALLING SEQUENCE
-19	BASE PAGE STORE (STA B.1)	LDA "VALUE TO STORE" LDB "DESTINATION ADDRESS" JSB EXEC DEF *+2 DEF RCODE (RETURN WITH B = FORMER VALUE +1) . . RCODE DEC - 19
-20	TO LOAD AND START EXECUTION OF A PROGRAM WHOSE DIRECTORY ENTRY IS IN LOCATIONS 141-153 OCTAL	STORE DIRECTORY ENTRY OF DESIRED PROGRAM IN LOCATIONS 141-153B JSB EXEC DEF *+2 DEF RCODE (RETURN) . . RCODE DEC - 20
-21	TO INITIALIZE TBG (IF IN SYSTEM) FOR .1 SECOND TIMED INTERRUPTS	JSB EXEC DEF *+2 DEF RCODE (RETURN) . . RCODE DEC - 21
-22	TO EXECUTE AN I/O INSTRUCTION	LDA "I/O INSTRUCTION" JSB EXEC DEF *+2 DEF RCODE (RETURN) . . RCODE DEC - 22

DOSM DISC I/O WITH EXEC CALLS
(ABSOLUTE DISC ADDRESSING)

GENERAL CALLING SEQUENCE:

JSB EXEC (TRANSFER TO EXEC)
 DEF RTN (DEFINE RETURN ADDRESS)
 DEF RCODE (SEE BELOW)
 DEF CNTLW (SEE BELOW)
 DEF BUFFR (DEFINE BUFFER ADDRESS)
 DEF BUFFL (DEFINE BUFFER LENGTH)
 DEF TRCK (DEFINE TRACK #)
 DEF SECT (DEFINE SECTOR #)
 RTN (RETURN POINT)

RCODE	CNTLW	DISC AREA ADDRESSED
+1 (READ) +2 (WRITE)	2	"WORK AREA" ON <u>SYSTEM DISC</u> ONLY. SYSTEM CHECKS FOR LEGALITY OF TRCK/SECT IN CALL.
-1 (READ) -2 (WRITE)	2	"ANY AREA" ON <u>SYSTEM DISC</u> . SYSTEM DOES NOT CHECK FOR LEGALITY OF TRCK/SECT IN CALL.
	3	"ANY AREA" ON <u>CURRENT USER DISC</u> . SYSTEM DOES NOT CHECK FOR LEGALITY OF TRCK/SECT IN CALL.
	-3	"ANY AREA" ON <u>CURRENT JOB FILE</u> (<u>JFILE</u>) DISC. SYSTEM DOES NOT CHECK FOR LEGALITY OF TRCK/SECT IN CALL.

NOTE: SYSTEM WILL HALT (WITH T-REG. =102031 OCTAL)
 IF DISC PROTECT OVERRIDE SWITCH IS "OFF" (DOWN)
 AND REQUEST MADE TO WRITE ON A SECTOR THAN IS
 FLAGGED PROTECTED (PCI=1).

BINARY TAPES NEEDED FOR SYSTEM GENERATION (PART 1)

PROGRAM(S)	# TAPES	COMMENTS
SYSTEM GENERATOR	1	OPERATES IN SIO ENVIRONMENT, THEREFORE THE FOLLOWING SIO DRIVERS MAY BE NEEDED: TELETYPE, PHOTOREADER, PUNCH (IF SIO DUMP TO BE USED), AND MAGNETIC TAPE. GENERATOR CONTAINS DISC I/O DRIVER INTERNAL TO ITSELF, THEREFORE, NO SIO DISC DRIVER NEEDED.
DISC MONITOR (CORE RESIDENT SYSTEM)	1	ALWAYS MADE CORE RESIDENT BY GENERATOR. GOOD PRACTICE TO LOAD AS FIRST PROGRAM FOR SYSTEM COMPATABILITY BETWEEN PROGRAMS LOADED ON OTHER SYSTEMS.
EXECUTIVE MODULES AND SUBROUTINES	1	MUST BE INCLUDED IN SYSTEM GENERATION. CONTAINS \$EX01 - \$EX20 EXEC MODULES AND SUBROUTINES \$LBL, \$SRCH, \$ADDR, ASCII, DUMRX. ALL EXEC MODULES ARE PROGRAM TYPE 1 (SYSTEM DISC RESIDENT), BUT MAY BE MADE SYSTEM CORE RESIDENT DURING GENERATION (PROGRAM TYPE 0). CAUTION: IF CERTAIN EXEC MODULES ARE MADE SYSTEM CORE RESIDENT, THEIR ASSOCIATED SUBROUTINES MUST ALSO BE DECLARED CORE RESIDENT.
I/O DRIVERS	1 PER DRIVER	DVR31 (IOMEC DISC DRIVER) MUST ALWAYS BE INCLUDED. IT IS DECLARED PROGRAM TYPE 0 (SYSTEM CORE RESIDENT) AND MUST NOT BE REDECLARED. DVR05 DVR00 ONE OF THESE DRIVERS MUST BE INCLUDED. BOTH ARE DECLARED PROGRAM TYPE 0 (SYSTEM CORE RESIDENT). THE ONE TO BE USED AS SYSTEM TELETYPE MUST NOT BE REDECLARED AS DISC RESIDENT. DVR05 IS SHORTED IN CORE REQUIREMENTS. ALL OTHER DRIVERS ARE DECLARED PROGRAM TYPE 4 (DISC RESIDENT I/O DRIVER) AND MAY BE REDECLARED PROGRAM TYPE 0 IF DESIRED.
JOB PROCESSOR	1	MUST ALWAYS BE INCLUDED IN GENERATION. MUST ALWAYS BE DISC RESIDENT.
RELOCATING LOADER	1	DOES NOT HAVE TO BE INCLUDED IN SYSTEM GENERATION, BUT IF NOT INCLUDED NO PROGRAMS COULD BE RELOCATED INTO CORE IMAGE ABSOLUTE FORM BY THE SYSTEM THAT IS GENERATED. DECLARED PROGRAM TYPE 3 (USER MAIN) AND MAY NOT BE MADE CORE RESIDENT. MUST ALWAYS BE DISC RESIDENT.

BINARY TAPES NEEDED FOR SYSTEM GENERATION (PART 2)

PROGRAM(S)	# TAPES	COMMENTS
EXTENDED ASSEMBLER	7	DOES NOT HAVE TO BE INCLUDED IN SYSTEM GENERATION. ONE TAPE IS THE MAIN PROGRAM (TYPE 3) AND SIX TAPES ARE SEGMENTS (PROGRAM TYPE 5). THE MAIN PROGRAM (ASMB) MUST BE LOADED PRIOR TO ITS SEGMENTS. MUST ALWAYS BE DISC RESIDENT.
HP BASIC FORTRAN COMPILER	5	DOES NOT HAVE TO BE INCLUDED IN SYSTEM GENERATION. ONE TAPE IS THE MAIN PROGRAM (TYPE 3) AND FOUR TAPES ARE SEGMENTS (PROGRAM TYPE 5). THE MAIN PROGRAM (FTN) MUST BE LOADED PRIOR TO ITS SEGMENTS. MUST ALWAYS BE DISC RESIDENT.
HP ALGOL COMPILER	2	DOES NOT HAVE TO BE INCLUDED IN SYSTEM GENERATION. ONE TAPE IS THE MAIN PROGRAM (TYPE 3) AND ONE SMALL TAPE IS THE ONLY SEGMENT (PROGRAM TYPE 5). THE MAIN PROGRAM (ALGOL) MUST BE LOADED PRIOR TO THE SEGMENT. MUST ALWAYS BE DISC RESIDENT. REQUIRES 16K MINIMUM CORE.
HP FORTRAN IV COMPILER	19	DOES NOT HAVE TO BE INCLUDED IN SYSTEM GENERATION. ONE TAPE IS THE MAIN PROGRAM (TYPE 3) AND 18 OTHER TAPES ARE ITS SEGMENTS (PROGRAM TYPE 5). THE MAIN PROGRAM (FTN4) MUST BE LOADED PRIOR TO THE 18 SEGMENTS. MUST ALWAYS BE DISC RESIDENT.
CROSS REFERENCE TABLE GENERATOR	1	DOES NOT HAVE TO BE INCLUDED IN SYSTEM GENERATION. DECLARED PROGRAM TYPE 3 (USER DISC RESIDENT MAIN). MUST BE DISC RESIDENT.
LIBRARIES	5	THE LIBRARIES INCLUDED DURING SYSTEM GENERATION WILL DEPEND ON THE PARTICULAR SYSTEM THAT IS BEING GENERATED AND WILL VARY ACCORDINGLY. FACTORS THAT WILL HELP DETERMINE ARE: <ol style="list-style-type: none"> 1. Is EAU TO BE USED. 2. Is FORTRAN IV COMPILER TO BE INCORPORATED INTO SYSTEM. 3. Is PLOTTING EQUIPMENT TO BE USED.
ANY USER PROGRAMS TO BE MADE A PERMANENT PART OF SYSTEM	?	SAME CONVENTIONS MUST BE FOLLOWED IN SEGMENTATION. USER MAIN MUST BE LOADED PRIOR TO SEGMENTS ETC. LIBRARY PROGRAMS MUST BE DECLARED TYPE 6 OR 7.

NOTE: IF THE FORTRAN IV LIBRARY IS TO BE INCLUDED IN AN 8K SYSTEM, CERTAIN RULES MUST BE FOLLOWED:

1. THE SYSTEM MUST BE GENERATED WITHOUT ANY COMPILERS OR AN ASSEMBLER.
2. A MAGNETIC TAPE SIO DRIVER CANNOT BE USED WITH DSGEN.
3. THE COMPILERS AND ASSEMBLER MUST BE LOADED INTO THE SYSTEM DURING OPERATION (USING THE LOADER).

DOSM GENERAL CORE LAYOUT

2x example

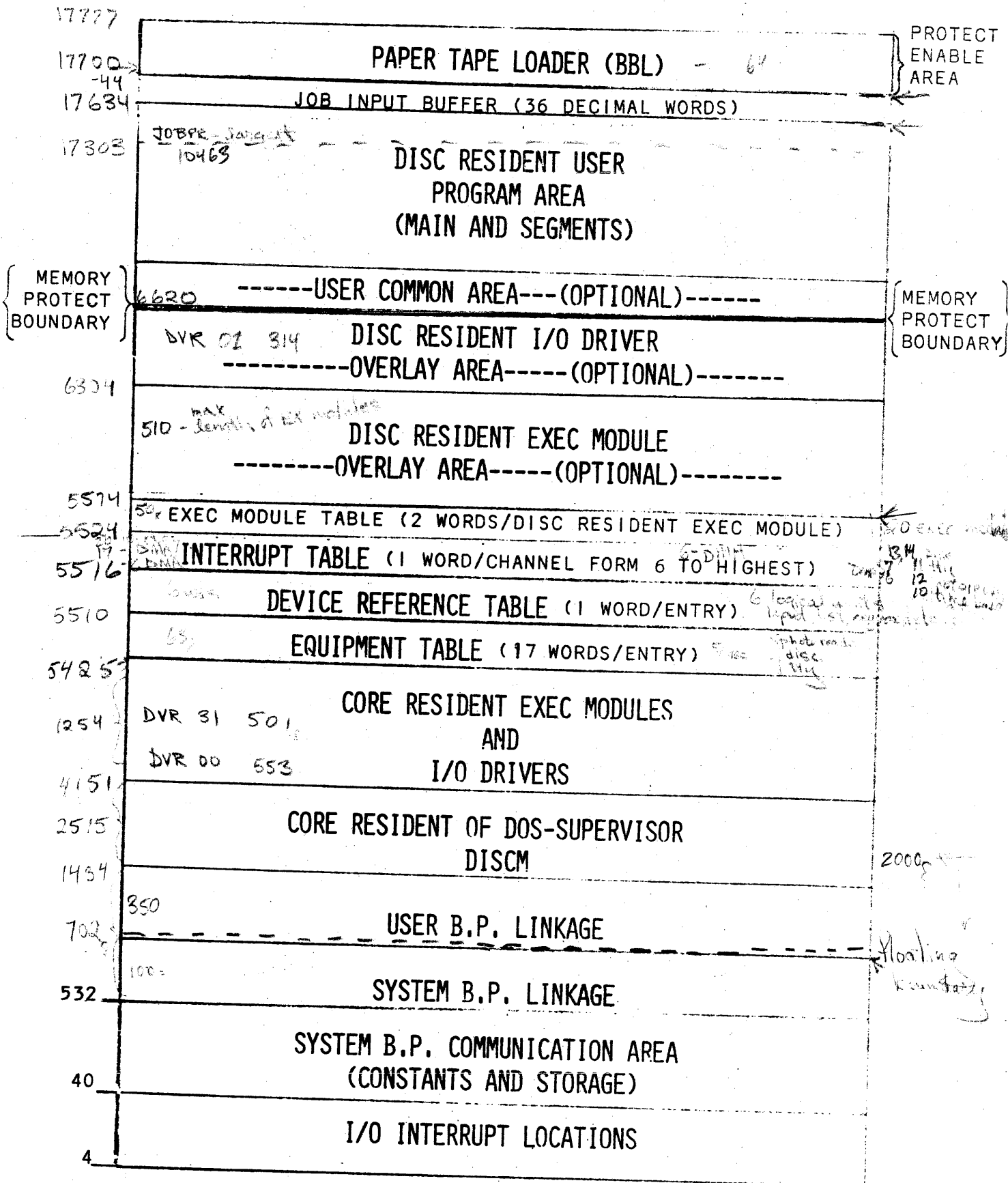

SYSTEM SOFTWARE SIZE BREAKDOWN ("A" VERSIONS)

PROGRAM NAME	LENGTH (OCTAL)	LENGTH (DECIMAL)	EXTERNAL ROUTINES
DISCM	2515	1357	-----
\$EX01	62	50	\$ADDR
\$EX02	50	40	\$ADDR
\$EX03	35	29	-----
\$EX04	315	205	ASCII
\$EX05	156	110	\$SRCH
\$EX06	37	31	\$ADDR, \$SRCH
\$EX07	157	111	\$ADDR
\$EX08	143	99	\$ADDR
\$EX09	261	177	ASCII
\$EX10	156	110	-----
\$EX11	164	116	\$SRCH
\$EX12	172	122	-----
\$EX13	342	226	ASCII
\$EX14	360	240	ASCII
\$EX15	272	186	ASCII
\$EX16	133	91	-----
\$EX17	373	251	\$LBL
✓ \$EX18	510	328	-----
\$EX19	320	208	\$LBL
\$EX20	306	198	ASCII
\$LBL	73	59	
\$SRCH	304	196	
\$ADDR	15	13	
ASCII	72	58	
DUMRX	64	52	
✓ DVR00 <i>Hy (photo reader) capability</i>	553	363	
✓ DVR01 <i>photo reader</i>	314	204	
DVR02	202	130	
DVR05	250	168	
DVR10	135	93	
DVR12	527	343	
DVR15	325	213	
DVR22	634 <i>797 0</i>	412	
DVR23	566	374	
DVR30	252	170	
✓ DVR31 <i>Disc</i>	501	321	
✓ JOBPR	10463	4403	
LOADR	7032	3610	

DOSM SYSTEM GENERATION EXAMPLE ("A" VERISION TAPES USED)

- 9000 **SYS GEN CODE?** *written in label field of system disc for ident. (decimal #)*
- 14 **SYS DISC CHNL?** *select code of disc controller (octal #)*
- 12 **# SECTORS/TRACK?** *12 for 2770 (same disc)*
- 200 **SYS DISC SIZE?** *# tracks*
- 1 **# DRIVES?**
- 0 **FIRST SYSTEM TRACK?**
- 3 **FIRST SYSTEM SECTOR?**

INITIALIZATION PHASE

- 1 **SYS DISC SUBCHNL?**
- 1 **USER DISC SUBCHNL?**
- 12 **TIME BASE GEN CHNL?**
- NO **IS 2114?**

if type of TRG is not present

→ 37677 **LWA MEM?** *last word of available core memory - [basic binary loader (BBL) starts in 37700]*

→ YES **ALLOW :SS?** *(system search) directive*

→ PT **PRGM INPT?** *(type of 1st input unit for relocatable prog. module)*

→ PT **LIBR INPT?** *(type of optional input unit for RPL's)*

- DF - disc file
 - TY - teletype
 - PT - paper tape
 - MT - mag. tape
- for prog. input phase*

→ TY **PRAM INPT?** *(type of input unit for parameters in ^{param.} input phase [PT or TY])*

*EOT
*EOT
*EOT
*EOT
*EOT
*EOT
*EOT
*EOT
*EOT
*EOT
*EOT
*EOT
*EOT
*EOT
*EOT
*EOT
*EOT
*EOT
*EOT
*EOT
*EOT

- signifies end of tape when reading off it

press ~~key~~ switch on bits 001
EPR
...

01 terminates
00 prgm input
10 library input

PROGRAM INPUT PHASE

input all prog to be made permanent part of DOS M (must input main before segments)

NO UNDEF EXTS

ENTER PROG PARAMETERS

- SEX01,0 - Disc work Tracks Status
- SEX02,0 - " Limits
- SEX06,0 - User file name search
- SEX11,0 - System file name search - for file read/write
- SEX17,0 (I/O Process 0)
- SEX18,0 I/O Initiation Processor
- SADDR,0 Buffer addr validity check
- SLBL,0 Service routine for label checking
- SSRCH,0 Search system of user directory

PARAMETER INPUT PHASE (From TX in this)

- # SYSTEM LINKS? # of system linkages required in base page (130 min response)
- 177
- # USER LINKS? # of user linkages in B.P. (320 min #)
- 477

SYSTEM

DISCM	01634
✓*SCIC	01634
*\$SSTR	04160
*\$LDEX	04154
✓*EXEC	02214
*\$DISC	03400
*\$IDL1	03511
*\$MDLD	03020
*\$RQER	02635
*\$JLOD	03744
*\$MOVE	03361
*\$TYPE	03426
*\$SYIO	04165
*\$BFND	04267
*\$EFAD	02507
*\$ABRT	04010
*\$WAIT	03244
*\$ETEQ	03345
*\$BLOP	03177
*\$SCIC3	01714
*\$AVES	03563
*\$CLER	04044
*\$OPER	02212
*\$ERR01	02653
*\$ERR03	02657
*\$ERR04	02661
*\$ERR05	02663
*\$ERR06	02665
*\$LUCHK	02553
*\$DMA	03214
*\$MBSY	03207
*\$LDVR	03143
*\$RQEQ	02576
*\$DRIVR	02700
*\$ERRTN	02631
*\$IO.40	02521
*\$GDTK	03130
*\$DISCX	03117
*..RRL	04243
*\$DEF04	02445
*\$DEF19	04302
*\$DEF20	04303

\$EX01	04314
*\$EX01	04314
\$EX02	04376
*\$EX02	04376
\$EX06	04446
*\$EX06	04446
\$EX11	04505
*\$EX11	04505
\$EX17	04671

relative starting location
entry points

DISC LOADING PHASE



(CORE RESIDENT SECTION)

DISC LOADING PHASE (CON'T)

```

*SEX17  04671
SEX18   05264
*SEX18  05264

$ADDR   05774
*$ADDR  05774

$SRCH   06011
*$SRCH  06011
*$CMPR  06266

$LBL    06315
*$LBLIO 06354
*$ISLBL 06336
*$LBLMV 06330
*$CHSUM 06315
*$MESSG 06372

DVR05   06410
*I.05   06410
*C.05   06464

DVR31   06660
*I.31   06660
*C.31   06743
    
```

(CORE RESIDENT SECTION)



* EQUIPMENT TABLE ENTRY

- 11, DVR05, R teleprinter ^{let core → I/O slot} _{driven core resident} (B) TBG
- 13, DVR01 photoreader
- 14, DVR31, R, D JOMEC Disc ^(SYS Disc CHNL) **BUILD EQT TABLE**
- 16, DVR02 Punch
- 22, DVR22, D ^{DMA channel required} _{3030 mag tape}
- /E

* DEVICE REFERENCE TABLE

- 1 = EQT #? ^{logical unit} system teleprinter
- 1 entry in eqt table
- 2 = EQT #? user mass storage ^{DVR 31} (JOMEC disc)
- 3 = EQT #? System mass storage
- 3 = EQT #? Standard punch device **BUILD DRT TABLE**
- 4 = EQT #? standard input device (photoreader)
- 2 = EQT #? standard list device (teleprinter)
- 1 = EQT #? mag tape
- 7 = EQT #?
- 5 = EQT #?
- 8 = EQT #?
- /E

IT generated:

0 - no interrupt

* INTERRUPT TABLE

- 11, 1 *entry*
- 13, 2
- 15, 3
- 16, 4
- 23, 5
- /E

6	0	14	0
7	0	15	addr
10	0	16	addr
11	addr	17	0
12	TBG	20	0
13	addr	21	0
		22	0
		23	addr

14 locations in memory

BUILD INTERRUPT TABLE

EXEC SUPERVISOR MODULES

DISC LOADING PHASE (CON'T)

- SEX03 07567
- *SEX03 07567
- SEX04 07567
- *SEX04 07567
- ASCII 10104
- *CNDEC 10104
- *CNOCT 10110
- SEX05 07567
- *SEX05 07567
- SEX07 07567
- *SEX07 07567
- SEX08 07567
- *SEX08 07567
- SEX09 07567
- *SEX09 07567
- ASCII 10050
- *CNDEC 10050
- *CNOCT 10054
- SEX10 07567
- *SEX10 07567
- SEX12 07567
- *SEX12 07567
- SEX13 07567
- *SEX13 07567
- ASCII 10131
- *CNDEC 10131
- *CNOCT 10135
- SEX14 07567
- *SEX14 07567
- ASCII 10147
- *CNDEC 10147
- *CNOCT 10153
- SEX15 07567
- *SEX15 07567
- ASCII 10061
- *CNDEC 10061
- *CNOCT 10065

Main entry pt. subroutine



(DISC RESIDENT SECTION)

DISC LOADING PHASE (CON'T)

SEX16 07567
*SEX16 07567

SEX19 07567
*SEX19 07567

SEX20 07567
*SEX20 07567

ASCII 10075
*CNDEC 10075
*CNOCT 10101

I/O DRIVER MODULES

DVR01 10241
*I.01 10241
*C.01 10313

DVR02 10241
*I.02 10241
*C.02 10320

DVR22 10241
*I.22 10241
*C.22 11001

LWA SYS 11075 *last addr +1 of supervisor*

FWA USER? 12000 *1st wd of user prog. area*

USER SYSTEM PROGRAMS

LOADR 12000
*LOADR 12000

JOBPR 12000
*JOBPR 12000

ASMB 12000
*ASMB 16522
*?ASCN 13700
*?ASMB 12554
*?BNCN 14510
*?BPKU 15326
*?CHOP 12646
*?CHPI 15610
*?DCOD 15616
*?ENDS 15230
*?ERPR 15150

(DISC RESIDENT SECTION)

*?GETC	15654
*?MOVE	13437
*?MSYM	14775
*?RLUN	16375
*?AFLG	16430
*?LSTL	14717
*?LUNI	16436
*?RFLG	16425
*?Z	16446
*?ASM1	13371
*?LABE	13407
*?OKOL	15307
*?ORRP	14603
*?PNLE	16443
*?SETM	15674
*?SUP	15303
*?LPER	15306
*?PERL	15271
*?LOUT	15336
*?LTFL	15275
*?DRFL	16433
*?LTSA	15560
*?LTSB	15561
*?ORGS	15301
*?CNTR	15370
*?TSTR	16434
*?ASII	16452
*?ICSA	15146
*?FLGS	16422
*?RFLG	16423
*?LFLG	16424
*?TFLG	16426
*?X	16445
*?MESX	12505
*?ASCI	16451
*?LINC	15110
*?LINS	14765
*?LIST	14653
*?LUNP	16440

*?OPLK	12600
*?OPER	15640
*?PKUP	15321
*?PLIT	15406
*?PNCH	13632
*?PRNT	15033
*?RSTA	13105
*?LWA	16444
*?RDSC	16401
*?WEOF	16021
*?WRIF	16102
*?LGFL	16432
*?SEGM	12541
*?SYMK	13506
*?V	15633

DISC LOADING PHASE (CONT)



(DISC RESIDENT SECTION)

DISC LOADING PHASE (CON'T)

*?ARTL	15472
*?LST	15274
*?PLIN	16435
*?PCOM	15112
*?SECT	16420
*?NEAU	12443
*?HA38	15347
*?XRFI	12540
ASMBD	17120
*ASMBD	17442
ASMB1	17120
*ASMB1	17366
*?LITI	20030
*?CMQ	17560
*?INSR	17726
*?HA3Z	17527
*?ENP	17662
*?EXP	17645
ASMB2	17120
*ASMB2	17351
*?ART	20021
*?BREC	17475
*?LKLI	20535
*?SKPR	17441
*?SPCR	17444
ASMB3	17120
*ASMB3	17630
ASMB4	17120
*ASMB4	17366
*?INS?	17541
ASMB5	17120
*ASMB5	17351
FTN	12000
*%WLIC	13042
*%FTN0	12000
*%WPRN	12735
*%ERRR	12701
*%RDIS	12557
*%WDIS	12244
*%SEGN	12224
*%WTRA	12236
*%WSEC	12237
*%RTRA	12347
*%RSEC	12350
*%RBFA	12352
*%LUNO	12203
*%LUNI	12204

(DISC RESIDENT SECTION)

DISC LOADING PHASE (CONT)

*%TYP 12887
 *%WLIN 13017
 *%WPAG 13043
 *%TILT 13074
 *%RDSI 13044
 *%WDSI 13056
 *%WOUT 12334
 *%RBFW 12623
 *%LABL 12733
 *%CONA 12734
 *%ENDP 13105
 *%WDLU 12241
 *%RDLU 12346
 *%RFLG 12554
 *%WBFW 12341
 *%WBFA 12232
 *%HEDN 13010
 *%DUP8 12373
 *%NXDV 12402
 *%NELM 12352
 *%STYP 12433
 *%LGO 12202

FTN01 13127
 *%FTN1 16550
 SREAD 21241
 *%READ 21241
 *%JFIL 21707
 *%RDSC 21663
 .OPSY 21774
 *.OPSY 21774
 DUMRX 22034
 *%LIBR 22034
 *%LIBX 22062

FTN02 13127
 *%FTN2 13741

FTN03 13127
 *%FTN3 15117

FTN04 13127
 *%FTN4 13702
 %WRIT 17515
 *%WRIT 17700
 *%WRIF 17577
 *%WBUF 17777
 FADSB 20213
 *.FAD 20213

(DISC RESIDENT SECTION)

*.FSB 20222
 .OPSY 20363
 *.OPSY 20363
 .FLUN 20423
 *.FLUN 20423
 .PACK 20444
 *.PACK 20444
 DUMRX 20560
 *SLIBR 20560
 *SLIBX 20606
 .ZRLB 20644
 *.ZRLB 20644
 DLDST 20705
 *.DLD 20705
 *.DST 20715

*SYSTEM STORED ON DISC

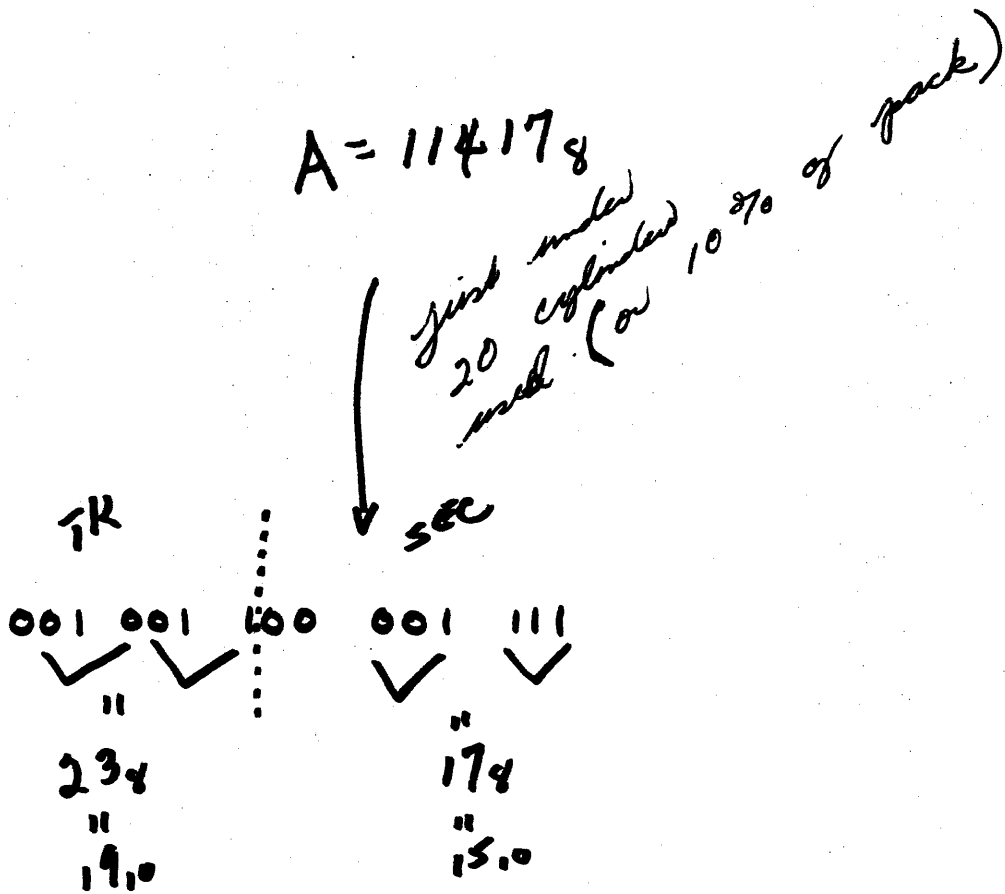

[SLIDE 40J]

FORMATTING USER DISCS OR CARTRIDGES

PURPOSE: TO FORMAT A USER DISC OR CARTRIDGE ANYTIME A NEW DISC IS ADDED OR AN OLD SYSTEM DISC IS TO BE REUSED AS A USER DISC.

WHAT SYSTEM DOES: CREATES AN UNLABELED DISC READY FOR USE IN DOSM SYSTEM BY

1. WRITING NEW LABEL SECTOR ON SECTOR 0 WITH
 - A. FIRST TWO WORDS AS 0,DO
 - B. GENERATION CODE # ENTERED BY OPERATOR
 - C. THREE LABEL WORDS AS *Y,ST,EM
 - D. # BAD TRACKS AS 0
2. WRITING NEW BOOTSTRAP ON SECTORS 1 AND 2
3. CLEARING ALL PCI AND DCI ON ALL SECTORS

OPERATION PROCEDURE:

1. ALL EQUIPMENT ON. "READY" DRIVE.
2. DISC PROTECT OVERRIDE SWITCH "ON".
3. LOAD CONFIGURED SYSTEM GENERATOR (DSGEN) INTO MEMORY USING BBL.
4. LOAD ADDRESS 100 OCTAL.
5. SWITCH 15 "UP".
6. PRESET AND RUN.
7. ANSWER REQUESTS PRINTED ON TTY.
8. SYSTEM GENERATOR HALTS WITH T=102007 AT END. PRESS "RUN" TO DO ANOTHER DISC (WITH SWITCH 15 STILL "UP") OR PUT SWITCH 15 DOWN AND PRESS "RUN" TO BEGIN SYSTEM GENERATION PROPER.

FORMATTING USER DISCS EXAMPLE

SYS GEN CODE?
→ 9000

SYS DISC CHNL?
→ 14

SECTORS/TRACK?
→ 12

USER DISC SUBCHNL?
→ 0

TURN ON DISC PROTECT OVERRIDE - PRESS RUN

USER DISC SUBCHNL?
→ 1

FORMATTED FIXED
DISC

FORMATTED
CARTRIDGE

SYS GEN CODE?
→ 9000

SYS DISC CHNL?
→ 14

SECTORS/TRACK?
→ 12

SYS DISC SIZE?
→ 200

DRIVES?
→ 1

FIRST SYSTEM TRACK?
→ 0

FIRST SYSTEM SECTOR?
→ 3

SYS DISC SUBCHNL?
→ 1

USER DISC SUBCHNL?
→ 1

TIME BASE GEN CHNL?
→ 12

IS 2114?
→ NO

LWA MEM?
→ 37677

ALLOW :SS?
→ YES

PRGM INPT?
→ PT

LIBR INPT?
→ PT

WENT DIRECTLY INTO
STANDARD SYSTEM GENERATION
BY PUTTING SWITCH 15 DOWN
AND PRESSING "RUN"

DOSM ABSOLUTE DISC FILE FORMAT
(ENTRY TYPES 1, 2, 3, 4, AND 5)

11 WORD DIRECTORY ENTRY

(WORD 4 GIVES TRACK/SECTOR ORIGIN)

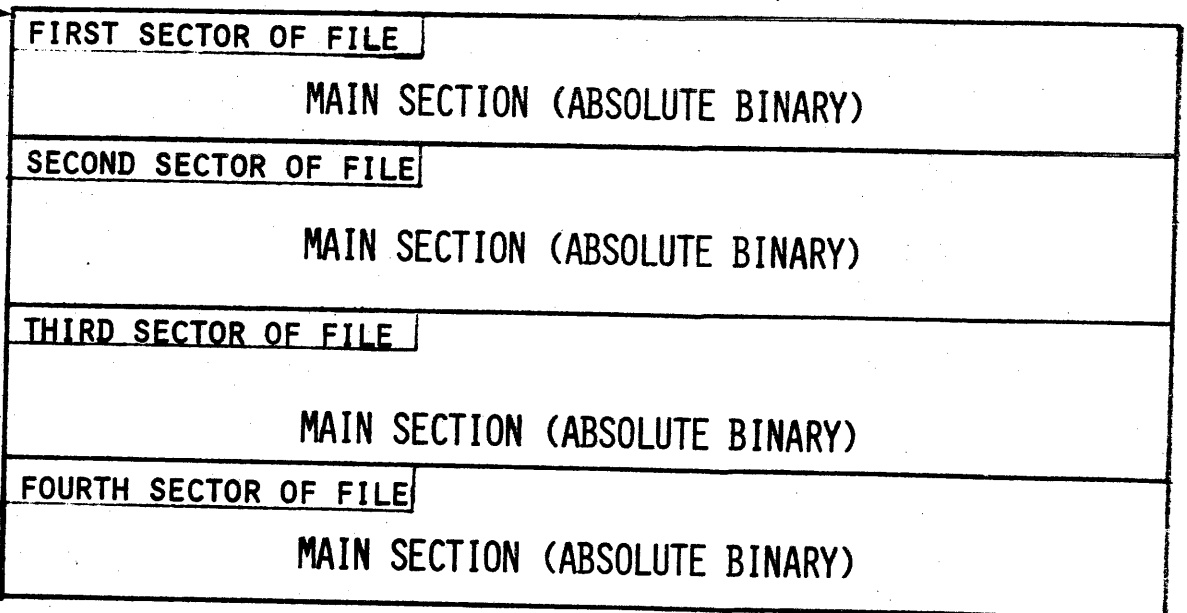

⋮

ALWAYS
SECTOR
BOUNDARY

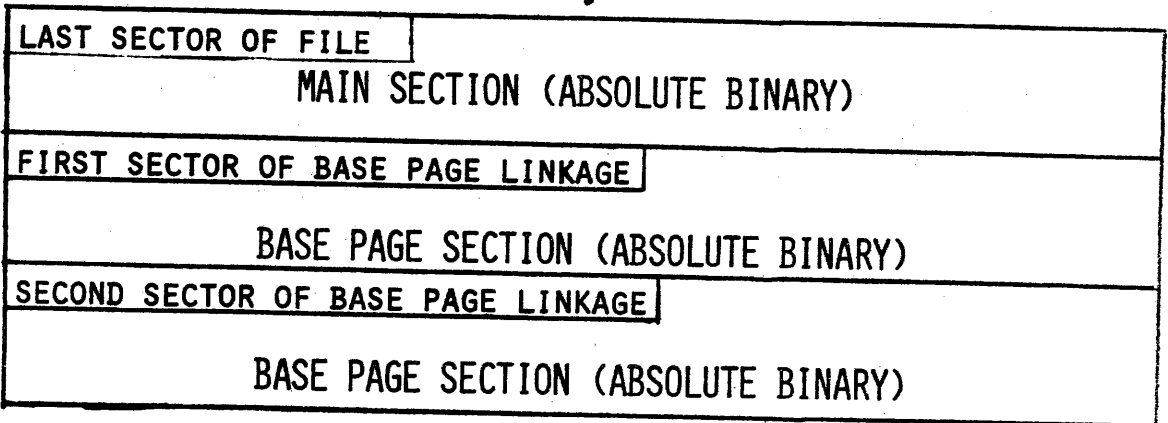

⋮

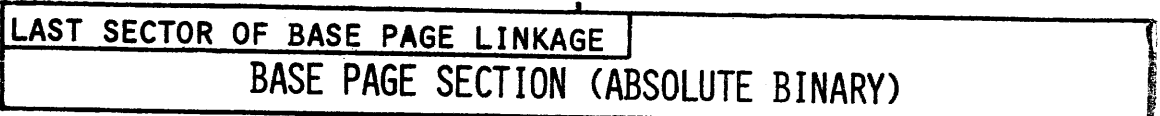

DOSM RELOCATABLE DISC FILE FORMAT
(ENTRY TYPES 6, 7 AND 8)

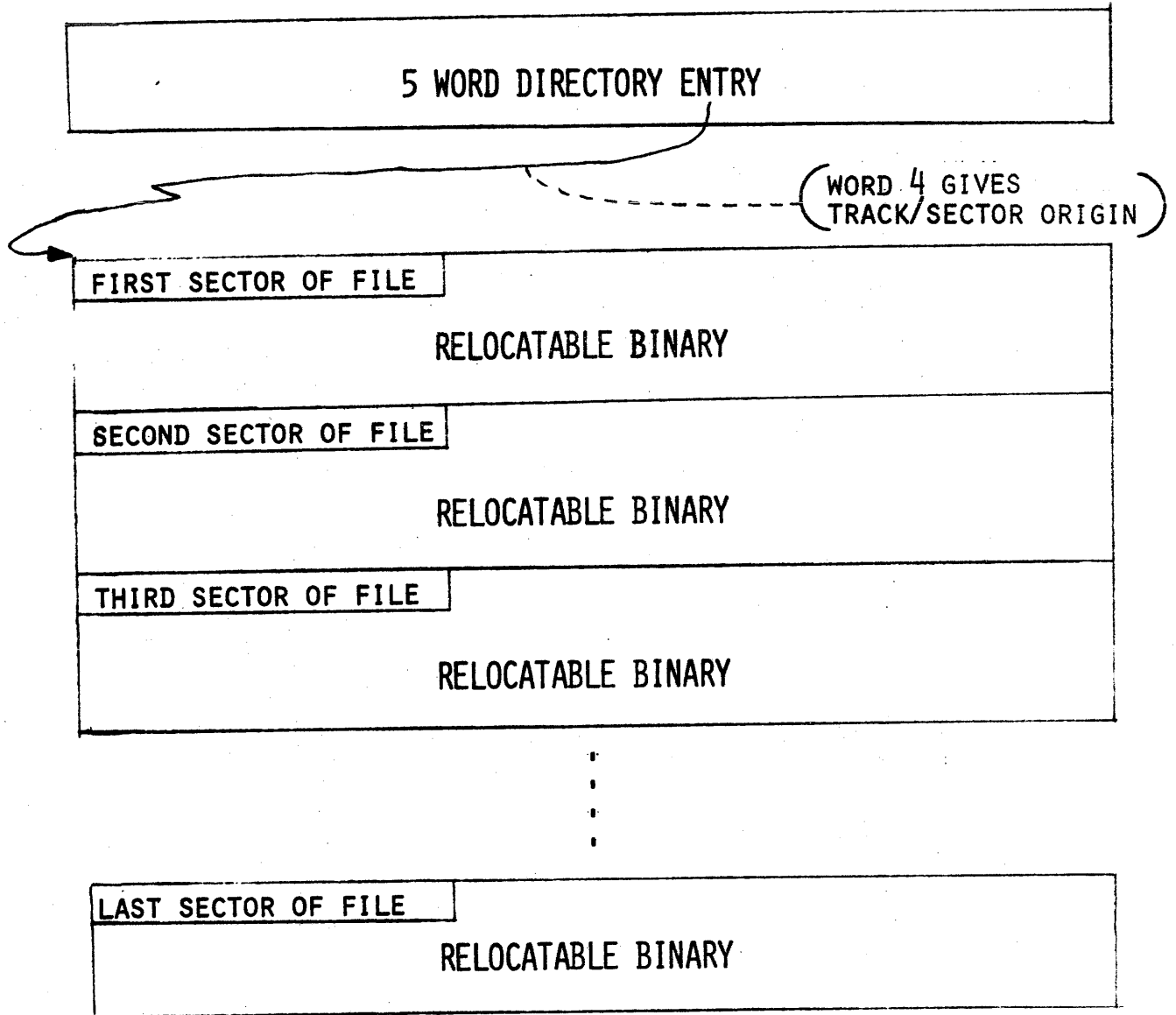

NOTE: "NAM" RECORD LENGTH FOR RTE/DOS/DOSM SYSTEMS IS 17 WORDS IN LENGTH WHICH IS INCOMPATIBLE TO "NAM" RECORD LENGTH OF 9 WORDS OF BCS SYSTEMS.

DOSM ASCII SOURCE STATEMENT DISC FILE FORMAT
(ENTRY TYPE 9)

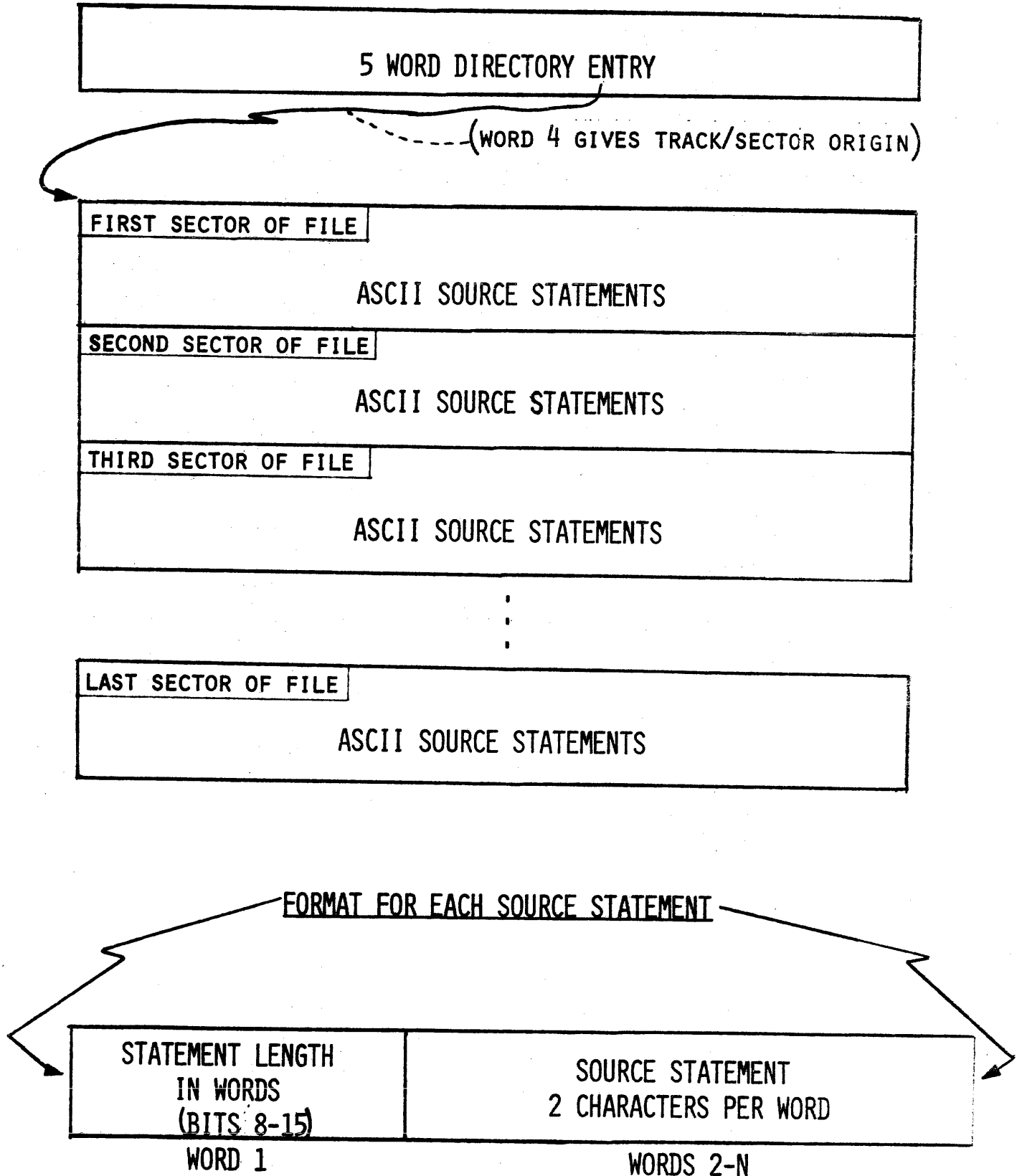

ASCII SOURCE FILE FORMAT EXAMPLE

INPUT :DATE,XXXXXXXXXX,H,M

@:DA,27.OCT.70,9,15

SUBCHAN=1

LBL=QQQQQ

@

:JOB,ASCII

JOB ASCII 27.OCT.70 TIME=0555 MIN. 16.0 SECS.

@

:ST,S,SORSE,1

AAAA
BBBBB
CCCCC
DDDDDD

SOURCE FILE CREATED

::

0004 LINES

@

:LIST,U,1,SORSE

NAME TYPE SCTRS DISC ORG PROG LIMITS B.P. LIMITS ENTRY LIBR. P-BIT

USCHAN=1

SORSE SS 0001 T055 003

@

:SO,55,3

	AA	AA	BB	BB	BB	
001	001000	040501	040501	001400	041102	041102
	041503	041503	041503	002000	042104	042104
	000000	177777	020000	036164	000000	041456
	036164	000000	046117	040504	051000	036155
	041120	051000	036146	000000	040523	046502
	000000	037501	051503	047000	036137	000000
	041000	036137	000000	037502	047103	047000
	037502	050113	052400	036137	000000	037503
	033403	000000	000312	000024	177767	040523
	031067	027117	041524	027067	030040	000000
	000000	000000	000000	000000	000000	000005
	000003	000004	000002	000001	000005	000000
	050521	050421	044456	031461	020000	037515
	036137	000000	037522	046125	047000	036137
	043114	043400	036137	000000	037514	051524
	000000	037514	052516	044400	036137	000000
						037522
						051502

2 WORDS

EOF

3 WORDS

3 WORDS

DOSM "SYSTEM" DISC LAYOUT FOR GENERATION EXAMPLE

DISC ADDRESS
(TK/SEC)

SYSTEM LABEL/USER BUFFER SECTOR		0,0
DISC RESIDENT BOOTSTRAP (2 Sectors)		0,1
SYSTEM DIRECTORY		0,3
DISC MONITOR EXEC MODULES AND SUBROUTINES I/O DRIVERS	CORE RESIDENT SYSTEM PART 2	0,10
EQUIPMENT TABLE DEVICE REFERENCE TABLE INTERRUPT TABLE	CORE RESIDENT SYSTEM PART 3	1,9
DISC RESIDENT EXEC MODULES AND SUBROUTINES		1,11
DISC RESIDENT I/O DRIVERS		3,1
DISC RESIDENT SYSTEM MAIN PROGRAMS AND THEIR SEGMENTS (JOBPR, LOADR, ASMB, FTN, ALGOL, ETC.)		3,12
EXEC MODULE DOUBLET TABLE	CORE RES. SYS. PART 4	13,6
DISC RESIDENT RELOCATABLE LIBRARY		13,7
BASE PAGE SECTION OF CORE RESIDENT SYSTEM (TRAP CELLS, CONSTANTS, COMMUNICATION, LINKAGE)	CORE RESIDENT SYSTEM PART 1	19,11
SPECIAL SYSTEM TRACK		21,0
USER LABEL/SYSTEM BUFFER SECTOR		22,0
USER DIRECTORY		22,1
USER FILES AND PROGRAMS		23,0
WORK AREA		55,3
JOB BINARY AREA		
3 SPARE TRACKS (END OF DISC)		200,0

(HARDWARE PROTECTED)

(SOFTWARE PROTECTED)

"SYSTEM" DISC (LABEL SECTORS DESCRIPTION)

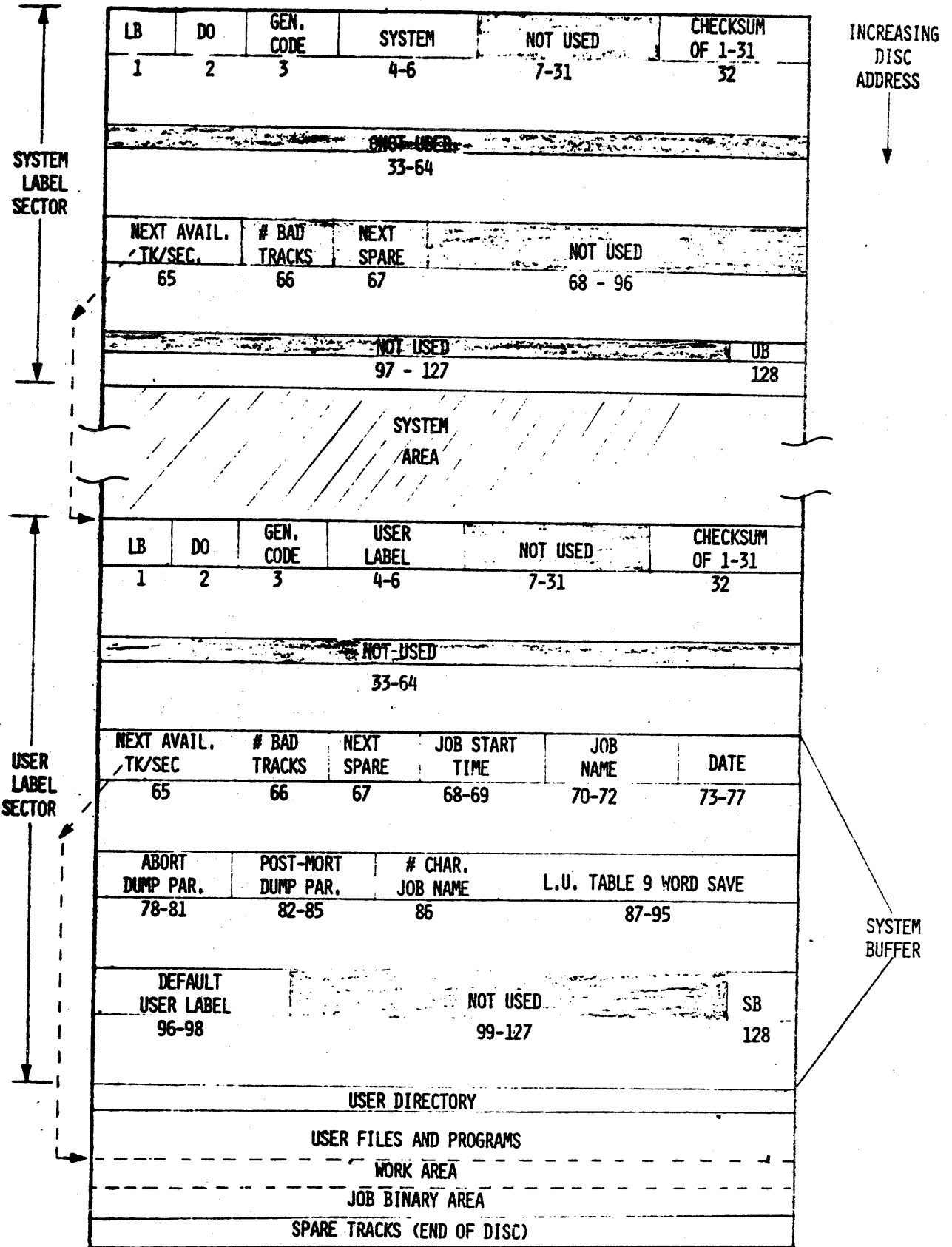

DIRECTORY ENTRY FORMAT

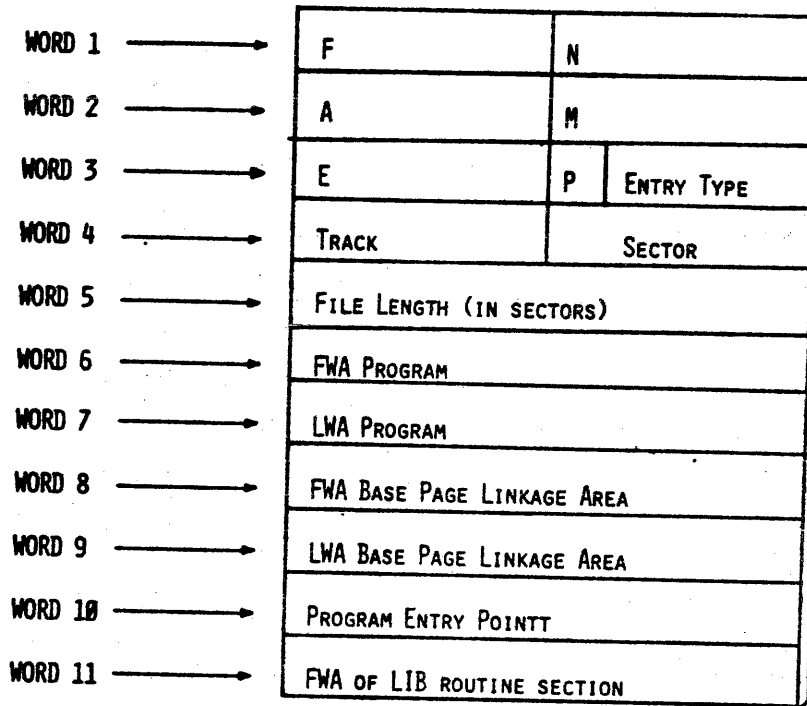

FOR SYSTEM GENERATED
BINARY PROGRAMS ONLY

ENTRY TYPE

FILE

0	_____	SYSTEM RESIDENT
1	_____	DISC RESIDENT EXECUTIVE SUPERVISOR MODULE
2	_____	CURRENTLY UNUSED
3	_____	USER PROGRAM, MAIN
4	_____	DISC RESIDENT DEVICE DRIVER
5	_____	USER PROGRAM, SEGMENT
6,7	_____	LIBRARY
10 ₈	_____	RELOCATABLE BINARY
11 ₈	_____	ASCII SOURCE STATEMENTS
12 ₈	_____	BINARY DATA
13 ₈	_____	ASCII DATA

'P' BIT

0 = NO ACTION

1 = PURGE THIS ENTRY AT THE END OF THE JOB OR FOLLOWING ANY EXECUTION OF :PU DIRECTIVE. THIS BIT IS SET BY THE LOADER AND CLEARED BY A :STORE,P,[file-name] REQUEST.

THE LAST DIRECTORY ENTRY IN EACH SECTOR IS FOLLOWED BY A WORD CONTAINING '-1' UNLESS THE GIVEN SECTOR IS EXACTLY FILLED WITH ENTRIES.

THE LAST ENTRY IN THE DIRECTORY IS FOLLOWED BY A WORD CONTAINING ZERO.

CORE MAP FOR DOSM SYSTEM GENERATION EXAMPLE (16K)

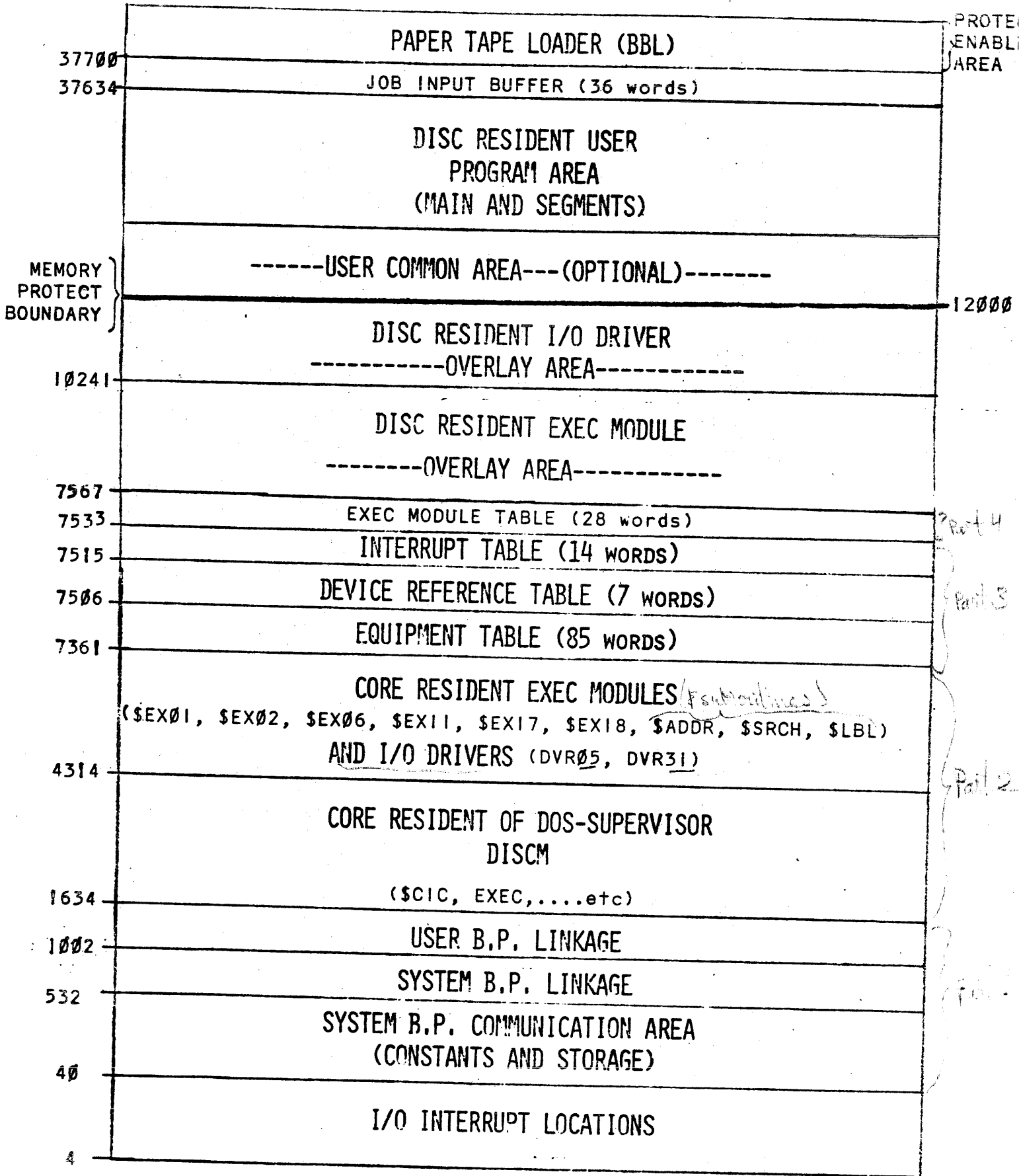

EQUIPMENT TABLE ENTRY FORMAT

WORD	CONTENTS															
1	DRIVER "INITIATION" SECTION ADDRESS															
2	DRIVER "CONTINUATION" SECTION ADDRESS															
3	D	R					UNIT #	CHANNEL #								
4	AV		EQUIPMENT TYPE CODE				STATUS									
5	(SAVED FOR DRIVER USE)															
6	(SAVED FOR DRIVER USE)															
7	REQUEST RETURN ADDRESS															
8	REQUEST CODE															
9	CURRENT I/O REQUEST CONTROL WORD															
10	REQUEST BUFFER ADDRESS															
11	REQUEST BUFFER LENGTH															
12	TEMPORARY OR DISC TRACK #															
13	TEMPORARY OR STARTING SECTOR #															
14	TEMPORARY STORAGE FOR DRIVER															
15	UPPER MEMORY ADDRESS OF MAIN DRIVER AREA															
16	UPPER MEMORY ADDRESS OF DRIVER LINKAGE AREA															
17	STARTING TRACK #								STARTING SECTOR #							
BITS	15	14	13	12	11	10	9	8	7	6	5	4	3	2	1	0

D
R
UNIT #
CHANNEL #

- 1 IF DMA CHANNEL REQUIRED.
- 1 IF DRIVER TYPE IS CORE-RESIDENT.
- MAY BE USED FOR SUB-CHANNEL ADDRESSING.
- I/O SELECT CODE FOR DEVICE (LOWER NUMBER IF MULTIBOARD INTERFACE.)

AV

- 0 - UNIT NOT BUSY AND AVAILABLE
- 1 - UNIT DISABLED (DOWN)
- 2 - UNIT BUSY
- 3 - UNIT WAITING FOR AN AVAILABLE DMA CHANNEL (THIS FIELD SET BY SYSTEM)

STATUS - ACTUAL OR SIMULATED UNIT STATUS AT END OF OPERATION (DRIVER MUST SET THIS FIELD)

EQUIPMENT TYPE CODE - IDENTIFIES TYPE OF DEVICE AND ASSOCIATED SOFTWARE DRIVER. ASSIGNED EQUIPMENT TYPE CODES IN OCTAL AR

00-07 PAPER TYPE DEVICES

- 00 TELEPRINTER
- 01 PUNCHED TAPE READER
- 02 HIGH SPEED PUNCH
- 05 TELETYPE (SYSTEM)

10-17 UNIT RECORD DEVICES

- 10 RESERVED FOR PLOTTER
- 12 LINE PRINTER
- 15 MARK SENSE CARD READER

20-37 MAGNETIC TAPE/MASS STORAGE AND OTHER DEVICES CAPABLE OF BOTH INPUT AND OUTPUT.

- 22 3030 MAGNETIC TAPE
- 31 MOVING-HEAD DISC

0's IF CORE-RESIDENT

FOR EQUIPMENT TYPE CODES 1 THROUGH 17, ODD NUMBER INDICATE INPUT DEVICES AND EVEN NUMBER INDICATE OUTPUT DEVICES (EXCEPT 05, WHICH IS BOTH INPUT AND OUTPUT).

AVAILABLE FOR DRIVER TEMPORARY

DEVICE REFERENCE TABLE FORMAT

EACH ENTRY IN THIS TABLE REQUIRES ONLY ONE WORD IN MEMORY. THE VALUE OF EACH ENTRY (DECIMAL NUMBER, 1-63) ASSOCIATES A LOGICAL UNIT NUMBER WITH AN EQUIPMENT TABLE ENTRY FOR THE SYSTEM IN THE FOLLOWING MANNER:

SEQUENCE IN MEMORY TABLE	LOGICAL UNIT #	FUNCTION
1	1	SYSTEM TELEPRINTER
2	2	USER MASS STORAGE
3	3	SYSTEM MASS STORAGE
4	4	STANDARD PUNCH DEVICE
5	5	STANDARD INPUT DEVICE
6	6	STANDARD LIST DEVICE
7-63	7-63	ANY DEVICE

INTERRUPT TABLE FORMAT

EACH ENTRY IN THIS TABLE REQUIRES ONLY ONE WORD IN MEMORY AND IS ASSOCIATED WITH EACH I/O CHANNEL IN THE COMPUTER (STARTING WITH LOCATION 6) WHICH CAN CAUSE AN INTERRUPT. EACH LOCATION IN THIS TABLE HAS AN ENTRY VALUE. MEMORY LOCATIONS ARE ASSOCIATED IN CONSECUTIVE INCREASING ORDER WITH AN I/O CHANNEL. TABLE VALUES ARE ZERO FOR AN I/O CHANNEL NOT REQUIRING INTERRUPT. I/O CHANNELS REQUIRING INTERRUPT CONTAIN THE START ADDRESS OF THE EQUIPMENT TABLE ENTRY OF THE ASSOCIATED DEVICE.

SYSTEM DIRECTORY LISTING FOR GENERATION EXAMPLE

NAME	TYPE	SCTRS	DISC	ORG	PROG	LIMITS	B.P.	LIMITS	ENTRY	LIBR.	P-RIT
SUBCHAN=1											
SEX03	XS	0002	T001	011	07567	07624	00732	00733	07567	07624	
SEX04	XS	0004	T001	013	07567	10176	00732	00741	07567	10176	
SEX05	XS	0002	T001	017	07567	07745	00732	00733	07567	07745	
SEX07	XS	0002	T001	019	07567	07746	00732	00733	07567	07746	
SEX08	XS	0002	T001	021	07567	07732	00732	00733	07567	07732	
SEX09	XS	0003	T001	023	07567	10142	00732	00763	07567	10142	
SEX10	XS	0002	T002	002	07567	07745	00732	00733	07567	07745	
SEX12	XS	0002	T002	004	07567	07761	00732	00733	07567	07761	
SEX13	XS	0004	T002	006	07567	10223	00732	00754	07567	10223	
SEX14	XS	0004	T002	010	07567	10241	00732	00751	07567	10241	
SEX15	XS	0003	T002	014	07567	10153	00732	00763	07567	10153	
SEX16	XS	0002	T002	017	07567	07722	00732	00733	07567	07722	
SEX19	XS	0003	T002	019	07567	10107	00732	01000	07567	10107	
SEX20	XS	0003	T002	022	07567	10167	00732	00761	07567	10167	
DVR01	DR	0003	T003	001	10241	10555	01000	01002	10241	10555	
DVR02	DR	0003	T003	004	10241	10443	01000	01002	10241	10443	
DVR22	DR	0005	T003	007	10241	11075	01000	01002	10241	11075	
LOADF	UM	0032	T003	012	12000	21032	01002	01425	12000	21032	
JOBPR	UM	0038	T004	020	12000	22463	01002	01414	12000	22463	
ASMR	UM	0023	T006	010	12000	17120	01002	01362	16522	17120	
ASMRD	US	0004	T007	009	17127	17647	01362	01363	17442	17647	
ASMR1	US	0006	T007	013	17366	20542	01362	01424	17366	20542	
ASMR2	US	0007	T007	019	17345	20550	01362	01410	17351	20550	
ASMR3	US	0003	T008	002	17473	17771	01362	01363	17630	17771	
ASMR4	US	0004	T008	005	17366	20027	01362	01371	17366	20027	
ASMR5	US	0006	T008	009	17345	20425	01362	01404	17351	20425	
FTN	UM	0006	T008	015	12000	13127	01002	01047	12000	13127	
FTN01	US	0031	T008	021	13254	22120	01047	01502	16550	22120	
FTN02	US	0025	T010	004	13254	21027	01047	01356	13741	21027	
FTN03	US	0024	T011	005	13254	20600	01047	01277	15117	20600	
FTN04	US	0025	T012	005	13254	20750	01047	01360	13702	20750	
LIBRY	LR	0147	T013	007							

EXEC MODULE DOUBLET TABLE FORMAT

(TWO WORDS PER DISC RESIDENT EXEC MODULE)

WORD #1	# SECTORS - 1	EXEC MODULE ID #
	15-11	10-0

WORD #2	START TRACK #	START SECTOR #
	15-8	7-0

CORE MAP FOR DOSM SYSTEM GENERATION EXAMPLE (16K)

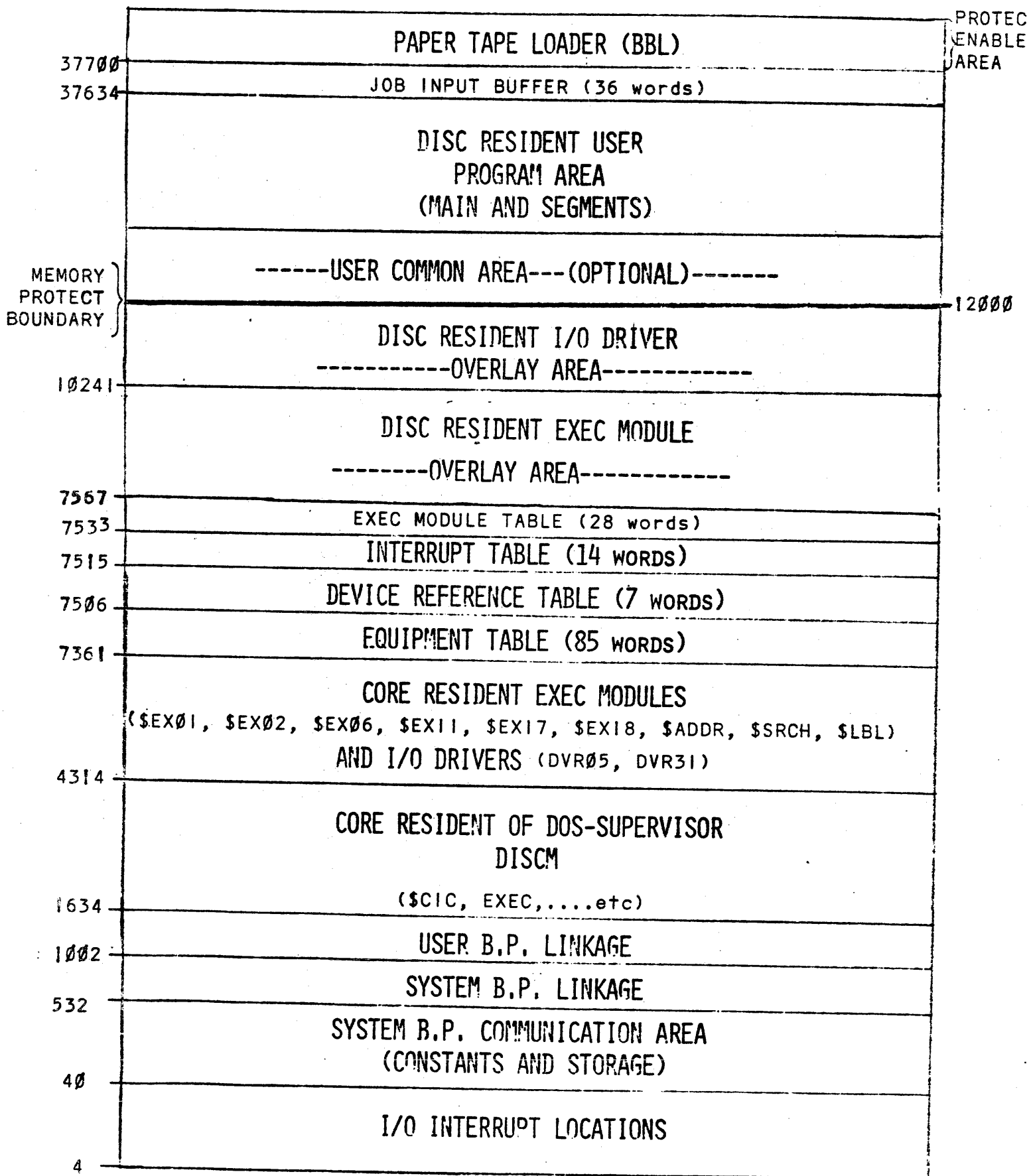

"SYSTEM" DISC (LABEL SECTORS DESCRIPTION)

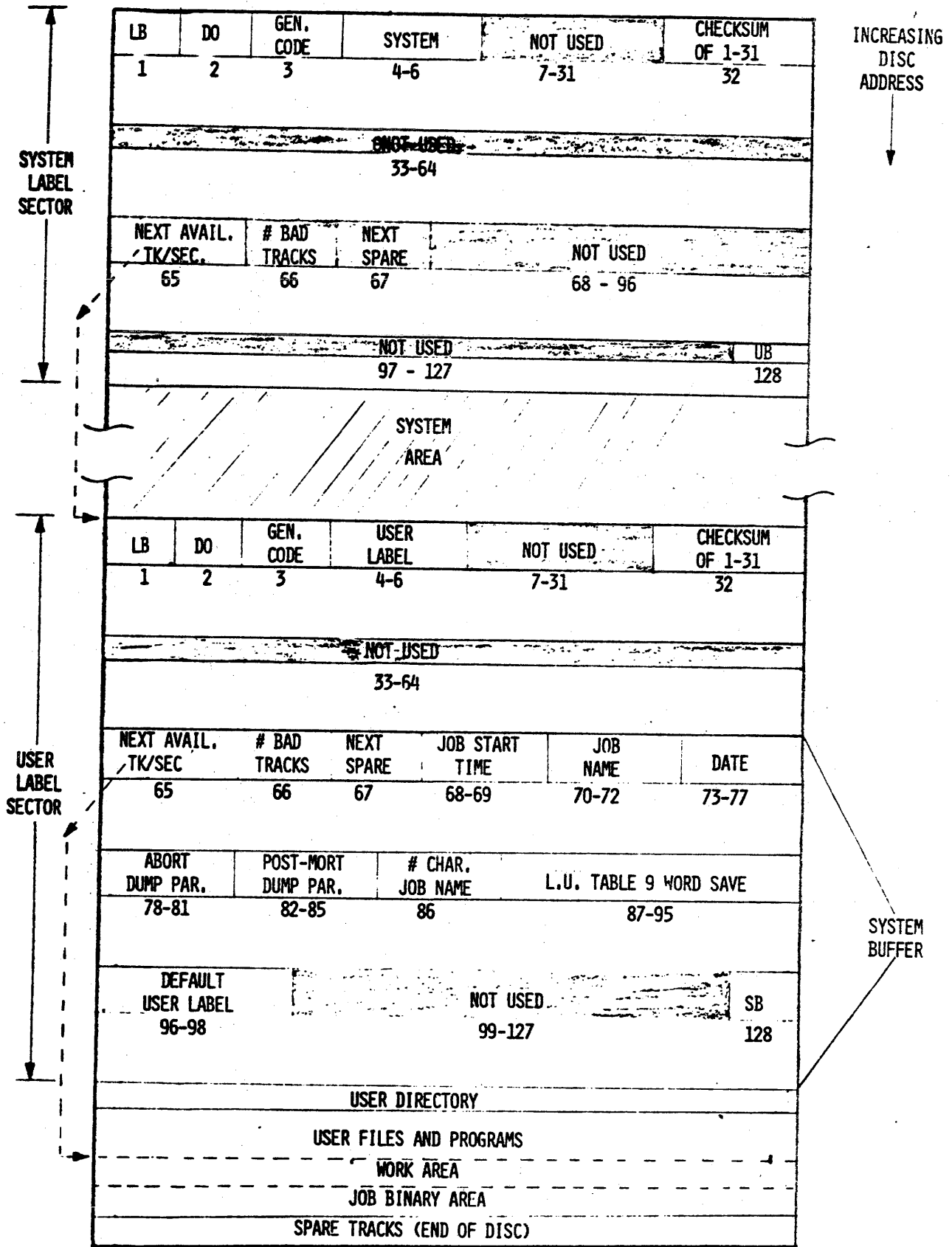

DIRECTORY ENTRY FORMAT

WORD 1	→	F	N
WORD 2	→	A	M
WORD 3	→	E	P ENTRY TYPE
WORD 4	→	TRACK	SECTOR
WORD 5	→	FILE LENGTH (IN SECTORS)	
WORD 6	→	FWA PROGRAM	
WORD 7	→	LWA PROGRAM	
WORD 8	→	FWA BASE PAGE LINKAGE AREA	
WORD 9	→	LWA BASE PAGE LINKAGE AREA	
WORD 10	→	PROGRAM ENTRY POINTT	
WORD 11	→	FWA OF LIB ROUTINE SECTION	

FOR SYSTEM GENERATED
BINARY PROGRAMS ONLY

ENTRY TYPE

FILE

0	———	SYSTEM RESIDENT
1	———	DISC RESIDENT EXECUTIVE SUPERVISOR MODULE
2	———	CURRENTLY UNUSED
3	———	USER PROGRAM, MAIN
4	———	DISC RESIDENT DEVICE DRIVER
5	———	USER PROGRAM, SEGMENT
6,7	———	LIBRARY
10 ₈	———	RELOCATABLE BINARY
11 ₈	———	ASCII SOURCE STATEMENTS
12 ₈	———	BINARY DATA
13 ₈	———	ASCII DATA

'P' BIT

0 = No ACTION

1 = PURGE THIS ENTRY AT THE END OF THE JOB OR FOLLOWING ANY EXECUTION OF :PU DIRECTIVE. THIS BIT IS SET BY THE LOADER AND CLEARED BY A :STORE,P,[file-name] REQUEST.

THE LAST DIRECTORY ENTRY IN EACH SECTOR IS FOLLOWED BY A WORD CONTAINING '-1' UNLESS THE GIVEN SECTOR IS EXACTLY FILLED WITH ENTRIES.

THE LAST ENTRY IN THE DIRECTORY IS FOLLOWED BY A WORD CONTAINING ZERO.

USER DIRECTORY LISTING IN GENERATION EXAMPLE SYSTEM

NAME	TYPE	SCTRS	DISC	ORG	PROG	LIMITS	B.P.	LIMITS	ENTRY	LIBR.	P-BIT
SUBCHAN=1											
XREF	UM	0013	T023	000	12000	14750	01002	01036	12000	14071	
EOT1	SS	0001	T023	013							
WEOT	UM	0002	T023	014	12000	12013	01002	01003	12000	12013	
XREFR	RB	0016	T023	016							
DISCM	RB	0020	T024	008							
EXECS	RB	0063	T025	004							
DVR05	RB	0003	T027	019							
DVR31	RB	0005	T027	022							
LIBRY	RB	0143	T028	003							
DVR02	RB	0002	T034	002							
DVR01	RB	0003	T034	004							
DVR22	RB	0007	T034	007							
LODR	RB	0049	T034	014							
JOBP	RB	0065	T036	015							
ASMBL	RB	0040	T039	008							
ASMD	RB	0004	T041	000							
ASM3	RB	0004	T041	004							
ASM4	RB	0006	T041	008							
ASM5	RB	0010	T041	014							
FRTN	RB	0008	T042	000							
FTN1	RB	0048	T042	008							
FTN2	RB	0045	T044	008							
FTN3	RB	0042	T046	005							
FTN4	RB	0031	T047	023							
ASM1	RB	0012	T049	006							
ASM2	RB	0011	T049	018							
SI01	SS	0005	T050	005							
BASC1	SS	0009	T050	010							
BOOT	SS	0021	T050	019							
FTNH	SS	0001	T051	016							
EOF	UM	0001	T051	017	12000	12013	01002	01002	12000	12013	
FSPACE	UM	0001	T051	018	12000	12013	01002	01002	12000	12013	
RWIND	UM	0001	T051	019	12000	12013	01002	01002	12000	12013	
D.00S	SS	0067	T051	020							
TSRTS	SS	0006	T054	015							
TSRTR	RB	0005	T054	021							
CLEAR	BD	0001	T055	002							

RB
 0013
 0001
 0002
 0016
 0020
 0063
 0003
 0005
 0143
 0002
 0003
 0007
 0049
 0065
 0040
 0004
 0004
 0006
 0010
 0008
 0048
 0045
 0042
 0031
 0012
 0011
 0005
 0009
 0021
 0001
 0001
 0001
 0001
 0067
 0006
 0005
 0001

0004*
0005* **SEEK RECORD** **000000**
0006*

0007	00002	000000	SEEK	NOP	
0008	00003	004155	LDB	CYL	CYLINDER (TRACK) NUMBER
0009	00004	100610	OTB	DC	OUTPUT CYL# TO DATA CHNL
0010	00005	100710	STC	DC,C	
0011	00006	000136	LDA	SRCMD	LOAD SEEK COMMAND
0012	00007	054154	CPB	LSTSK	* IF CYL# = LAST CYL# ACCESSED,
0013	00010	030151	TOR	MSIGN	* CHANGE CMND TO ADDRS RECORD
0014	00011	074154	STB	LSTSK	* UPDATE LAST SEEK INDICATOR
0015	00012	030157	TOR	DRV	INCLUDE DRIVE#
0016	00013	100711	CLC	CC	
0017	00014	100611	OTA	CC	OUTPUT SEEK/ADDRESS COMMAND
0018	00015	100711	STC	CC,C	TO CMND CHNL
0019	00016	102310	SFS	DC	
0020	00017	024010	JMP	*-1	← WAIT FOR CYL# ACCEPTANCE
0021	00020	060156	LDA	HDSECT	HEAD;BITS 15-8; SECTOR;BITS 7-0
0022	00021	100610	OTA	DC	OUTPUT HEAD/SECTOR TO DATA CHNL
0023	00022	100710	STC	DC,C	NOTE 3
0024	00023	102311	SFS	CC	* IN INTERRUPT MODE, EXIT HERE
0025	00024	024023	JMP	*-1	* AND RETURN ON INTERRUPT
0026	00025	014121	JSB	STAT	← (CHECK STATUS)
0027	00026	124002	JMP	SEEK,I	

0028*
0029* NOTE: EITHER A SEEK (000000) OR AN ADDRESS RECORD (1300000)
0030* COMMAND MUST BE ISSUED PRIOR TO ANY OTHER DISC COMMAND
0031* EXCEPT STATUS CHECK. ADDRESS RECORD MAY BE ISSUED ONLY
0032* IF THE HEAD (ON THE SELECTED DRIVE) IS ALREADY IN POSITION
0033* FOR THE CURRENT ACCESS; IT WILL EXECUTE FASTER THAN A
0034* SEEK UNDER THESE CONDITIONS. THE CODING IN THE EXAMPLE
0035* FOR CHECKIN THIS CONDITION IS APPLICABLE ONLY TO A SINGLE
0036* DRIVE SYSTEM. IN A MULTI-DRIVE ENVIRONMENT, PROVISION
0037* MUST BE MADE TO MAINTAIN AND CHECK THE HEAD POSITION
0038* INDICATOR FOR EACH DRIVE.
0039*

NOTE 1 : BITS 0-7 = CYLINDER # ; BITS 8-15 = 0

NOTE 2 : BITS 12-15 = COMMAND CODE ; BITS 0-1 = DRIVE #

NOTE 3 : BITS 8-9 = HEAD # ; BITS 0-3 = SECTOR #

0041*					
0042*	READ DATA				
0043*					
0044	00027	000000	READ	NOP	
0045	00030	000152		LDA DMACW	LOAD DMA CONTROL WORD,
0046	00031	030153		ZOR DCHNL	INCLUDE DATA CHNL#,
0047	00032	102606		OTA 6	AND OUTPUT TO DMA CHNL
0048	00033	100702		CLC 2	
0049	00034	060160		LDA CORAD	LOAD CORE BUFFER ADDRESS,
0050	00035	030151		ZOR MSIGN	INCLUDE DIRECTION BIT,
0051	00036	102602		OTA 2	AND SET IN MEMORY ADDRESS REG
0052	00037	102702		STC 2	
0053	00040	060161		LDA WDCNT	LOAD NEG # OF WORDS
0054	00041	102602		OTA 2	AND SET IN WORD COUNT REG
0055	00042	103710		STC DC,C	SET DATA CHNL FOR INPUT NOTE 1
0056	00043	060140		LDA RDCMD	LOAD READ COMMAND
0057	00044	030157		ZOR DRV	INCLUDE DRIVE#
0058	00045	100711		CLC CC	NOTE 2
0059	00046	102611		OTA CC	OUTPUT READ COMMAND TO CHNL
0060	00047	103706		STC 6,C	START DMA
0061	00050	103711		STC CC,C	START DATA TRANSFER
0062	00051	100706		CLC 6	INHIBIT DMA INTERRUPT
0063	00052	102311		SFS CC	* IN INTERRUPT MODE, EXIT HERE
0064	00053	024052		JMP 0-1	* AND RETURN ON INTERRUPT
0065	00054	014121		ZOR STAT ←	(CHECK STATUS)
0066	00055	124027		END READ, I	

NOTE 1 : PULSE DATA CHANNEL TO RECEIVE DATA FROM CONTROLLER

NOTE 2 : BITS 13-15 = READ COMMAND ; BITS 0-1 = DRIVE #

0068*

0069* ***** WRITE *****

0070*

0071 00056 000000 WRITE NOP

0072 00057 060152 LDA DMACW LOAD DMA CONTROL WORD,

0073 00060 030153 IOR DCNHL INCLUDE DATA CHNL#,

0074 00061 102606 OTA 6 AND OUTPUT TO DMA CHNL

0075 00062 100702 CLC 0

0076 00063 060160 LDA CORAD LOAD CORE BUFFER ADDRESS

0077 00064 102602 OTA 2 AND SET IN MEMORY ADDRESS REG

0078 00065 102702 STC 2

0079 00066 060161 LDA WDCNT LOAD NEG # OF WORDS

0080 00067 102602 OTA 2 AND SET IN WORD COUNT REG

0081 00070 102110 STC DC SET DATA CHANNEL FOR OUTPUT

0082 00071 060144 LDA WRCMD LOAD WRITE COMMAND

0083 00072 030157 IOR DRVY INCLUDE DRIVE#

0084 00073 100711 CLC CC

0085 00074 102611 OTA CC OUTPUT WRITE CMND TO CMND CHNL

0086 00075 103706 STC 0,C START DMA

0087 00076 103711 STC CC,C START DATA TRANSFER

0088 00077 100706 CLC 6 INHIBIT DMA INTERRUPT

0089 00100 102311 SFS CC * IN INTERRUPT MODE, EXIT HERE

0090 00101 024100 JMP *-1 * AND WAIT FOR INTERRUPT

0091 00102 014121 JNB STAT ← (CHECK STATUS)

0092 00103 124056 JMP WRITE,I

0093*

0094* NOTE: THE *WRITE* SEQUENCE ABOVE MAY BE USED,
0095* WITH THE APPROPRIATE COMMAND, AS FOLLOWS:
0096*

0097* COMMAND (OCTAL) FUNCTION

0098*
0099* 010000 WRITE DATA

0100* 110000 INITIALIZE DATA

0101* (USED TO INITIALIZE ADDRESS
0102* FIELDS OF A NEW DISC)

0103* 110400 FLAG DEFECTIVE CYLINDER

0104* 111000 FLAG PROTECTED CYLINDER

0105*

0106* ALL EXCEPT WRITE DATA REQUIRE THAT THE
0107* DISC PROTECT OVERRIDE SWITCH BE TURNED ON
0108*

0109* ALL OF THESE COMMANDS ACTUALLY WRITE DATA IN

0110* THE SECTOR(S) BEING PROCESSED. IF THE WCR
0111* GOES TO ZERO BEFORE THE END OF THE SECTOR

0112* IS REACHED, THE REMAINDER OF THE SECTOR

0113* WILL BE FILLED WITH ZEROS; THUS IF ZERO

0114* WORDS ARE SPECIFIED, THE ENTIRE SECTOR IS

0115* WRITTEN WITH ZEROS.

0116*

0117* FLAG CYLINDER PROTECTED OR DEFECTIVE ARE SUBSETS

0118* OF THE INITIALIZE DATA COMMAND, AND WRITE THE

0119* ADDRESS FIELD(S) OF THE SECTOR(S) BEING PROCESSED.

0120*

0120*

0120*

0120*

0120*

0120*

0122*					
0123*	***** CHECK DATA *****				
0124*					
0125	00104	000000	CHECK	NOP	
0126	00105	060162	LDA	SCTRS	LOAD SECTOR COUNT TO BE CHECKED
0127	00106	102610	OTA	DC	AND OUTPUT TO DATA CHANNEL
0128	00107	103710	STC	DC,C	
0129	00110	060141	LDA	CHCMD	LOAD CHECK DATA COMMAND NOTE 1
0130	00111	030157	IOR	DRV	INCLUDE DRIVE#
0131	00112	100711	CLC	CC	
0132	00113	103611	OTA	CC,C	OUTPUT CHECK COMMAND NOTE 2
0133	00114	103711	STC	CC,C	TO CMND CHNL
0134	00115	102311	SFS	CC	* IN INTERRUPT MODE, EXIT HERE
0135	00116	024115	JMP	*-1	* AND RETURN ON INTERRUPT
0136	00117	014121	JSB	STAT	(CHECK STATUS)
0137	00120	124104	JMP	CHECK,I	

NOTE 1: A = + (# SECTORS TO BE CHECKED) BITS 0-4

NOTE 2: BITS 12-15 = CHECK DATA COMMAND
BITS 0-1 = DRIVE #

THE CONTROLLER EXECUTES THIS COMMAND MUCH AS IT DOES READ DATA; HOWEVER, NO TRANSFER OF DATA OCCURS. RESULTS OF CHECK MAY BE OBTAINED WITH STATUS COMMAND CALL.

0139*
 0140* ***** STATUS CHECK *****

0141*
 0142 00121 000000 STAT NOP
 0143 00122 100100 CLP 0 (TURN OFF INTERRUPT SYS IF IT'S ON)
 0144 00123 100710 STC DC,C SET DATA CHANNEL FOR INPUT
 0145 00124 060157 LSA DRV LOAD DRIVE#
 0146 00125 100711 CLC CC
 0147 00126 102611 OTA CC OUTPUT STATUS COMMAND
 0148 00127 100711 STC CC,C TO CMND CHANNEL
 0149 00130 102310 SFS DC
 0150 00131 024130 JMP ←-1
 0151 00132 100711 CLC CC
 0152 00133 102510 LSA DC GET STATUS FROM DATA CHNL
 0153 00134 102100 STP 0 (RESPI INTERRUPT SYS IF IT WAS ON)
 0154 00135 124121 JMP STAT,I
 0155*

0156* NOTE: IUMEC STATUS BITS

- 0157*
- 0158* 15 - ATTENTION - OPERATION COMPLETED
- 0159* 14 - FIRST SEEK - DRIVE HAS GONE FROM NOT READY TO READY
- 0160* 13 - OVERRUN - LATE DATA TRANSFER - HARDWARE FAILURE
- 0161* 12 - READ/WRITE UNSAFE - HARDWARE FAILURE
- 0162* 11 - ACCESS UNSAFE - HARDWARE FAILURE
- 0163* 10 - ACCESS HUNTING - HARDWARE FAILURE
- 0164* 9 - SEEK INCOMPLETE - HARDWARE FAILURE
- 0165* 8 - SEEK CHECK - SOFTWARE ERROR (E.G., CYL# > 202)
- 0166* 7 - (NOT USED)
- 0167* 6 - NOT READY (ALSO SET WHEN BITS 11 AND/OR 12 SET)
- 0168* 5 - END OF CYLINDER - SOFTWARE ERROR - ATTEMPTED TO WRITE PAST THE END OF A CYLINDER
- 0169*
- 0170* 4 - ADDRESS ERROR - ADDRESS ISSUED DOES NOT AGREE WITH DISC ADDRESS - HARDWARE FAILURE OR DISC NOT INITIALIZED - OR - IF BIT 3 IS ALSO ON, THEN THE CYLINDER BEING PROCESSED HAS BEEN FLAGGED DEFECTIVE.
- 0171*
- 0172*
- 0173*
- 0174*
- 0175* 3 - FLAGGED CYLINDER - SET IF CYLINDER BEING PROCESSED HAS BEEN FLAGGED PROTECTED OR (IF BIT 4 IS ALSO SET) DEFECTIVE - OR - INITIALIZE DATA COMMAND HAS BEEN ISSUED WITH DISC PROTECT OVERRIDE SWITCH OFF
- 0176*
- 0177*
- 0178*
- 0179* 2 - DRIVE BUSY - SEEK IN PROCESS
- 0180* 1 - DATA ERROR - CYCLIC CHECK INCORRECT
- 0181* 0 - ANY ERROR - TURNED ON WHEN ANY OF THE ABOVE EXCEPT BIT 15 OR, ON A READ OR CHECK DATA, BIT 3, IS SET.
- 0182*
- 0183*

0184* NOTE: ANY HARDWARE FAILURE WHICH DOES NOT SET BIT 6 MAY BE RECOVERABLE ON RETRY.
 0185*

0186*

0188*

0189***** DATA CONSTANT AND STORAGE AREA *****

0190*

0191	00010		DC	EQU 10B	DATA CHANNEL (HIGH PRIORITY)
0192	00011		CC	EQU 11B	COMMAND CHANNEL (LOW PRIORITY)

0193*

0194	00136	030000	SKCMD	OCT 030000	SEEK RECORD COMMAND
0195	00137	130000	ADCMD	OCT 130000	ADDRESS RECORD COMMAND

0196 00140 020000 RDCMD OCT 020000

READ DATA COMMAND

0197 00141 060000 CHCMD OCT 060000

CHECK DATA COMMAND

0198 00142 000000 STCMD OCT 000000

STATUS CHECK COMMAND

0199 00143 050000 RFCMD OCT 050000

REFINE SECTOR COMMAND

0200*

0201	00144	000000	WRCMD	NOP	STORAGE FOR CURRENT WRITE CMND
------	-------	--------	-------	-----	--------------------------------

0202*

0203	00145	010000	WDCMD	OCT 010000	WRITE DATA COMMAND
------	-------	--------	-------	------------	--------------------

0204	00146	110000	INCMD	OCT 110000	INITIALIZE DATA COMMAND
------	-------	--------	-------	------------	-------------------------

0205 00147 111000 PCCMD OCT 111000

FLAG PROTECTED CYLINDER CMND

0206 00150 110400 DCCMD OCT 110400

FLAG DEFECTIVE CYLINDER CMND

0207*

0208 00151 100000 MSIGN OCT 100000

BIT 15

0209 00152 120000 LMACW OCT 120000

UMA CONTROL WORD

0210*

0211	00153	000010	DCMNL	OCT 10	DISC DATA CHNL# (HP)
------	-------	--------	-------	--------	----------------------

0212	00154	000313	LSTSK	DEC 203	LAST SEEK IND. (INIT. > 202)
------	-------	--------	-------	---------	------------------------------

0213*

0214	00155	000000	CYL	NOP	CYLINDER#
------	-------	--------	-----	-----	-----------

0215	00156	000000	FLSCT	NOP	HEAD#(15-8), SCTR#(7-0)
------	-------	--------	-------	-----	-------------------------

0216	00157	000000	DRV	NOP	DRIVE#
------	-------	--------	-----	-----	--------

0217	00160	000000	CCRAD	NOP	CORE BUFFER ADDRESS
------	-------	--------	-------	-----	---------------------

0218	00161	000000	WICNT	NOP	NEG #WORDS TO BE TRANSFERRED
------	-------	--------	-------	-----	------------------------------

0219	00162	000000	SCTRS	NOP	POS #SCTRS TO BE CHECKED
------	-------	--------	-------	-----	--------------------------

0220*

0221 END

** NO ERRORS*

DOS-M SUPPLIED BOOTSTRAP ("A" VERSION)

BOOTSTRAP PROPER

```

0001          ASMB,L,A
0002*
0003 00002          ORG 2B
0004 00002 024223  JMP CONFIG ← GO CONFIGURE BOOTSTRAP
0005*
0006 00005          ORG 5B
0007 00005 102501  BOOT LIA 1          GET SYSTEM SUBCHNL
0008 00006 010200  AND M7
0009 00007 000065  CLE,ERA
0010 00010 070166  STA DRV#          SET DRIVE#
0011 00011 006400  CLB
0012 00012 106600  OTB DC           OUTPUT TRK#
0013 00013 103700  STC DC,C         FOR SEEK
0014 00014 030204  IOR SEEK
0015 00015 102601  OTA CC           OUTPUT SEEK CMND
0016 00016 103701  STC CC,C         TO COMMAND CHNL
0017 00017 102300  SFS DC
0018 00020 024017  JMP *-1 ← WAIT FOR TRACK # RECEIVED
0019 00021 060206  LDA HDSCT
0020 00022 002040  SEZ
0021 00023 010200  AND M7           SUBCHNL ON REMOVABLE PACK?
0022 00024 102600  OTA DC           -YES, SET HEAD# = 0
0023 00025 103700  STC DC,C         OUTPUT HEAD/SCTR
0024 00026 010203  AND M1774       TO DATA CHNL
0025 00027 070170  STA HDMSK
0026 00030 060207  LDA DMACW
0027 00031 102606  OTA 6           OUTPUT DMA CNTRL WORD
0028 00032 106702  CLC 2
0029 00033 060210  LDA MEMAD
0030 00034 102602  OTA 2           OUTPUT BFR ADDRS
0031 00035 102702  STC 2
0032 00036 060173  LDA N256
0033 00037 102602  OTA 2           OUTPUT WORD COUNT
0034 00040 102301  SFS CC           WAIT FOR SEEK
0035 00041 024040  JMP *-1         TO COMPLETE
0036 00042 014056  JSB STAT ← CHECK STATUS
0037 00043 060205  LDA READ
0038 00044 030166  IOR DRV#
0039 00045 106701  CLC CC
0040 00046 102601  OTA CC           OUTPUT READ COMMAND
0041 00047 103700  STC DC,C         SET DATA CHNL FOR READ
0042 00050 103706  STC 6,C         START DMA
0043 00051 103701  STC CC,C         START READ OPERATION
0044 00052 102301  SFS CC           WAIT FOR READ
0045 00053 024052  JMP *-1         TO COMPLETE
0046 00054 014056  JSB STAT ← CHECK STATUS
0047*
0048 00055 024110  JMP RELOC       GO RELOCATE BOOTSTRAP
0049*
0050 00056 000000  STAT NOP
0051 00057 103700  STC DC,C
0052 00060 060166  LDA DRV#
0053 00061 106701  CLC CC
0054 00062 102601  OTA CC           OUTPUT STATUS CMND
0055 00063 103701  STC CC,C         TO COMMAND CHNL
0056 00064 102300  SFS DC
    
```

BOOTSTRAP PR. FR

0057	00065	024064	JMP *-1	
0058	00066	102500	LIA DC	← GET STATUS
0059	00067	000010	SLA	ANY ERROR?
0060	00070	102011	HLT 11B	-YES
0061	00071	124056	JMP STAT,I	
0062*				
0063	00100		ORG 100B	BOOTSTRAP START ADDRESS
0064	00100	024005	JMP BOOT	
0065	00105		ORG 105B	
0066	00105	000222	DFEND DEF CHSUM	
0067*				
0068	00110		ORG 110B	
0069*				
0070	00110	002400	RELOC CLA	
0071	00111	170212	STA CLER1,I	
0072	00112	170213	STA CLER2,I	
0073	00113	060170	LDA HDMSK	
0074	00114	170214	STA ABHDM,I	SAVE HEAD# FOR DISC-RES. BOOT
0075	00115	060166	LDA DRV#	
0076	00116	170220	STA ADRV,I	
0077	00117	060165	LDA CHAN	
0078	00120	170215	STA ACHNL,I	SAVE DISC I/O CHNLS
0079	00121	170216	STA ADCHN,I	
0080	00122	002004	INA	FOR DISC-RESIDENT
0081	00123	170217	STA ACCHN,I	BOOTSTRAP
0082*				
0083	00124	064221	LDB SPPNT	
0084	00125	144221	ADB SPPNT,I	
0085	00126	160001	LDA B,I	GET ADDRESS OF ASPBF
0086	00127	010202	AND M76K	ISOLATE PAGE BITS
0087	00130	040176	ADA N2KB	SUBTRACT 1 PAGE
0088	00131	070171	STA PGMSK	
0089	00132	160001	LDA B,I	
0090	00133	010201	AND M1777	
0091	00134	030171	IOR PGMSK	
0092	00135	170001	STA B,I	ADJUST ASPBF ADDRESS
0093	00136	044175	ADB N1	
0094	00137	160001	LDA B,I	
0095	00140	010201	AND M1777	
0096	00141	030171	IOR PGMSK	
0097	00142	170001	STA B,I	ADJUST DEFDY
0098	00143	044175	ADB N1	
0099	00144	160001	LDA B,I	
0100	00145	010201	AND M1777	
0101	00146	030171	IOR PGMSK	
0102	00147	170001	STA B,I	ADJUST DVADR
0103	00150	060211	LDA DBOOT	
0104	00151	010201	AND M1777	
0105	00152	030171	IOR PGMSK	
0106	00153	070172	STA RELBT	SET TRANSFER ADDRESS
0107	00154	064173	LDB N256	
0108	00155	074167	STB WDCNT	
0109	00156	164211	MVMOR LDB DBOOT,I	*
0110	00157	174000	STB A,I	*
0111	00160	002004	INA	* RELOCATE
0112	00161	034211	ISZ DBOOT	* BOOTSTRAP

BOOTSTRAP PROPER

```

0113 00162 034167      ISZ WDCNT      *
0114 00163 024156      JMP MVMOR      *
0115*
0116 00164 124172      JMP RELBT,I ← TRANSFER TO DISC-RES. BOOTSTRAP
0117*
0118 00000              DC EQU 0        DISC DATA CHANNEL
0119 00001              CC EQU 1        DISC CMND CHANNEL
0120 00165 000000      CHAN NOP
0121 00166 000000      DRV# NOP
0122 00167 000000      WDCNT NOP
0123 00170 000000      HDMSK NOP
0124 00171 000000      PGMSK NOP
0125 00172 000000      RELBT NOP
0126 00173 177400      N256 DEC -256
0127 00174 177405      N251 DEC -251
0128 00175 177777      N1 DEC -1
0129 00176 176000      N2KB OCT -2000
0130 00177 177700      N100 OCT -100
0131 00200 000007      M7 OCT 7
0132 00201 001777      M1777 OCT 1777
0133 00202 076000      M76K OCT 76000
0134 00203 177400      M1774 OCT 177400
0135 00204 030000      SEEK OCT 030000
0136 00205 020000      READ OCT 020000
0137 00206 001001      HDSCT OCT 001001
0138 00207 120000      DMACW OCT 120000
0139 00210 115400      MEMAD OCT 115400
0140 00211 015400      DBOOT OCT 15400
0141 00212 015771      CLER1 OCT 15771
0142 00213 015772      CLER2 OCT 15772
0143 00214 015772      ABHDM OCT 15772
0144 00215 015773      ACHNL OCT 15773
0145 00216 015774      ADCHN OCT 15774
0146 00217 015775      ACCHN OCT 15775
0147 00220 015776      ABDRV OCT 15776
0148 00221 015777      SPPNT OCT 15777
0149*

```

BOOTSTRAP CONFIGURATOR

```

0151*
0152 00222 000000 CHSUM NOP
0153*
0154 00223 102501 CONFIG LIA 1 GET DISC DATA CHANNEL
0155 00224 010337 AND B77
0156 00225 070165 STA CHAN
0157 00226 030207 IOR DMACW
0158 00227 070207 STA DMACW CONFIGURE DMA CNTRL WORD
0159 00230 060337 LDA B77
0160 00231 003000 CMA
0161 00232 040327 ADA DEFBT
0162 00233 070330 STA CNTR
0163 00234 064327 LDB DEFBT
0164 00235 006004 CLOOP INB *
0165 00236 160001 LDA B,I *
0166 00237 002021 SSA,RSS * CONFIGURE ALL
0167 00240 024247 JMP CNEXT *
0168 00241 010340 AND MASK * DISC I/O
0169 00242 002002 SZA *
0170 00243 024247 JMP CNEXT * INSTRUCTIONS
0171 00244 160001 LDA B,I *
0172 00245 040165 ADA CHAN * IN BOOTSTRAP
0173 00246 170001 STA B,I *
0174 00247 034330 CNEXT ISZ CNTR
0175 00250 024235 JMP CLOOP
0176*
0177 00251 102501 LIA 1
0178 00252 002020 SSA PUNCH CONFIGURED BOOTSTRAP?
0179 00253 024256 JMP *+3 -YES
0180*
0181 00254 102077 HLT 77B
0182 00255 024254 JMP *-1 -NO (HALT IRRECOVERABLE)
0183*

```

PUNCH CONFIGURATED BOOTSTRAP

0185	00256	060334	LDA .2	
0186	00257	070326	STA ABSAD	SET BOOTSTRAP START ADDRESS
0187	00260	003004	CMA,INA	
0188	00261	040105	ADA DFEND	
0189	00262	070331	STA TEMP	SAVE BOOTSTRAP END ADDRESS
0190	00263	001727	ALF,ALF	
0191	00264	010203	AND M1774	
0192	00265	070325	STA RCLNG	SET PUNCH RECORD LENGTH
0193*				
0194	00266	002400	CLA	
0195	00267	070002	STA 2B	
0196	00270	070003	STA 3B	
0197	00271	070004	STA 4B	
0198	00272	060331	LDA TEMP	
0199	00273	003004	CMA,INA	
0200	00274	070330	STA CNTR	SET COUNTER FOR CHECKSUM
0201	00275	060326	LDA ABSAD	
0202	00276	064334	LDB .2	
0203	00277	140001	KLOOP ADA B,I	*
0204	00300	006004	INB	* GENERATE
0205	00301	034330	ISZ CNTR	* CHECKSUM
0206	00302	024277	JMP KLOOP	* FOR BBL
0207	00303	070222	STA CHSUM	*
0208*				
0209	00304	060332	PMORE LDA N50	
0210	00305	064341	LDB AFDJR	
0211	00306	114103	JSB HSPDR,I	PUNCH LEADER
0212*				
0213	00307	060333	LDA N2	
0214	00310	064324	LDB SHREC	
0215	00311	114103	JSB HSPDR,I	PUNCH RECORD LENGTH, ABS ADDR
0216*				
0217	00312	060331	LDA TEMP	
0218	00313	003004	CMA,INA	
0219	00314	002004	INA	
0220	00315	064336	LDB .4	
0221	00316	114103	JSB HSPDR,I	PUNCH BOOTSTRAP
0222*				
0223	00317	060332	LDA N50	
0224	00320	064341	LDB AFDJR	
0225	00321	114103	JSB HSPDR,I	PUNCH TRAILER
0226*				
0227	00322	102077	HLT 77B	
0228	00323	024304	JMP PMORE	
0229*				
0230	00324	000325	SHREC DEF ++1	
0231	00325	000000	RCLNG NOP	
0232	00326	000000	ABSAD NOP	
0233	00000		A EQU 0B	
0234	00001		B EQU 1B	
0235	00103		HSPDR EQU 103B	
0236	00327	000005	DEFBT DEF BOOT	
0237	00330	000000	CNTR NOP	
0238	00331	000000	TEMP NOP	
0239	00332	177716	N50 DEC -50	
0240	00333	177776	N2 DEC -2	

PAGE 0007 #01

0241	00334	000002	.2	OCT 2
0242	00335	000003	.3	OCT 3
0243	00336	000004	.4	OCT 4
0244	00337	000077	B77	OCT 77
0245	00340	070036	MASK	OCT 070036
0246*				
0247	00341	000342	AFDFR	DEF **1
0251				LST
0252*				
0253				END

** NO ERRORS*

DOS-M Disc RESIDENT BOOTSTRAP

PAGE 0127 #10

```

0350 15400          ORG 15400B
0351*
0352* THE FOLLOWING LOADER PERMITS LOADING OF THE RESIDENT PORTIONS
0353* OF THE DISC MONITOR SYSTEM. THE LOADER IS LOCATED ON SECTORS 1 & 2
0354* TRACK 0 OF THE SYSTEM DISC. IT IS GENERATED BY THE SYSTEM
0355* GENERATOR AND CONSISTS OF:
0356*
0357* (1) THE INSTRUCTIONS REQUIRED FOR LOADING THE SYSTEM
0358* (2) THE DISK AND CORE ADDRESSES SPECIFYING LOADING
0359*
0360*
0361* THE ADDRESSES REQUIRED FOR LOADING ARE THE FOLLOWING:
0362*
0363* (A) BASE PAGE LINKAGES
0364* (1) LOW CORE ADDRESS
0365* (2) HIGH CORE ADDRESS
0366* (3) DISK ADDRESS OF ABSOLUTE CODE
0367*
0368* (B) SYSTEM, M1 RESIDENT MAIN
0369* (1) LOW CORE ADDRESS
0370* (2) HIGH CORE ADDRESS
0371* (3) DISK ADDRESS OF ABSOLUTE CODE
0372*
0373*
0374*
0375*
0376*
0377 15400 000000  START NOP
0378 15401 067731  LDB DEFUD
0379 15402 017570  JSB CNFGR      CONFIG. BOOTSTRAP I/O INSTR.
0380 15403 067732  LDB ASPBF      GET APPRS OF DISC SPEC. BFR
0381 15404 077762  STB SPCAD      SET CURRENT SPBUF ADDRESS
0382 15405 017613  JSB PLOAD      LOAD BP LINKAGES
0383 15406 017613  JSB PLOAD      LOAD MAIN SYSTEM
0384 15407 017613  JSB PLOAD      LOAD I/O TABLES
0385 15410 017613  JSB PLOAD      LOAD EXEC DOUBLETS
0386*
0387 15411 064120  LDB BEQT#      GET # OF EQUIPMENT
0388 15412 007004  CMB,INB        TABLE ENTRIES AND
0389 15413 077310  STB CNTR        STORE NEGATIVE
0390 15414 064117  LDB BEQTB      GET FWA OF EQUIPMENT TABLE
0391 15415 044055  CNFG1 ADB .2
0392 15416 160001  LDA B,1 ← A = 3RD WORD OF EQT entry
0393 15417 044051  ADB .2N
0394 15420 010072  AND M.77
0395 15421 070773  STA CHANL      SAVE I/O CHANNEL#
0396 15422 050774  CPA RUND1      =RUN TIME DISC DATA CHNL?
0397 15423 077763  STB SWP1       -YES, SAVE
0398 15424 050775  CPA RUND2      =RUN TIME DISC CMND CHNL?
0399 15425 077764  STB SWP2       -YES, SAVE
0400 15426 077304  STB EQCUR      SAVE CURRENT EQPT TABLE ADDRESS
0401 15427 044056  ADB .3
0402 15430 160001  LDA B,1 ← A = 4TH WORD OF EQT entry
0403 15431 001727  ALF,ALF
0404 15432 010752  AND M.377
0405 15433 070305  STA EQPCD      SAVE EQPT TYPE CODE
    
```

RELEASED "A" VERSION 10-70

DOS-M DISC RESIDENT BOOTSTRAP

PAGE 0128 #10

0406	15434	050060	CPA .5	=SYSTEM TELETYPE?
0407	15435	02/460	JMP CNFG4	-YES
0408	15436	053765	CPA DISK	=DISC ?
0409	15437	02/445	JMP CNFG3	-YES
0410	15440	06/304	CNFG2 LDB EQCUR	
0411	15441	04/056	ADB .17D	INCR TO NEXT EQPMT TABLE ENTRY
0412	15442	03/310	ISZ CNTR	CHECKED ALL ENTRIES?
0413	15443	02/415	JMP CNFG1	-NO
0414	15444	02/505	JMP CNFG7	-YES
0415	15445	044052	CNFG3 ADB .1N	
0416	15446	160001	LDA B,I	
0417	15447	023773	XOR CHANL	
0418	15450	033774	IOR RUND1	
0419	15451	170001	STA B,I	SET DISC EQPT TABLE AT RUN TIME
0420	15452	063773	LDA CHANL	
0421	15453	073302	STA GEND1	SAVE DISC I/O CHN2 AT GEN. TIME
0422	15454	002004	INA	
0423	15455	073303	STA GEND2	SAVE GEN. DISC CMND CHNL
0424	15456	063774	LDA RUND1	
0425	15457	073773	STA CHANL	SET CHAN= RUN TIME DISC CHNL
0426	15460	06/304	CNFG4 LDB EQCUR	
0427	15461	160001	LDA B,I	
0428	15462	073730	STA DVADR	SAVE DRIVER ENTRY POINT
0429	15463	164000	LDB A,I	GET CONFIGURATION STOP POINT
0430	15464	01/570	JSB CNFGR	← CONF. ALL I/O INST. IN DRIVER
0431*				
0432	15465	063305	LDA EQPCD	GET EQPMT TYPE CODE
0433	15466	050060	CPA .5	=SYSTEM TELETYPE?
0434	15467	02/440	JMP CNFG2	-YES
0435	15470	006004	INB	-NO, MUST BE DISC
0436	15471	160001	LDA B,I	
0437	15472	033773	IOR CHANL	CONFIGURE DMA CNTRL WORD
0438	15473	170001	STA B,I	AND STORE
0439	15474	006004	INB	
0440	15475	063747	LDA #SPIK	* SET + AND -
0441	15476	170001	STA B,I	* SECTORS/TRACK
0442	15477	006004	INB	* IN
0443	15500	003004	CMA,INA	* DISC DRIVER
0444	15501	170001	STA B,I	*
0445	15502	06/304	LDB EQCUR	SAVE ADDRESS OF
0446	15503	07/311	STB EQDSK	DISC EQPMT TABLE
0447	15504	02/440	JMP CNFG2	
0448*				
0449	15505	060154	CNFG7 LDA BDSCU	* CONTINUE
0450*				
0451	15506	001722	ALF,RAL	*
0452	15507	013767	AND M.740	* SET RUN TIME
0453	15510	033774	IOR RUND1	* DISC CHANNEL
0454	15511	001727	ALF,ALF	* IN *DISCU*
0455	15512	001723	ALF,RAR	*
0456	15513	070154	STA BDSCU	*
0457*				
0458	15514	063763	LDA SWP1	*
0459	15515	06/302	LDB GEND1	* SET NEW ENTRIES
0460	15516	01/606	JSB INSWP	* IN SYS GEN. TIME
0461	15517	063764	LDA SWP2	* DISC CHANNEL

DOS-M DISC RESIDENT BOOTSTRAP

PAGE 0129 #10

0462	15520	06/303	LDB GEND2	* INTERRUPT TABLE LOCATIONS
0463	15521	017606	JSB INSWP	*
0464*				
0465	15522	002400	CLA	*
0466	15523	06/774	LDB RUND1	* SET RUN TIME
0467	15524	017606	JSB INSWP	* DISC CHANNELS
0468	15525	063311	LDA EQDSK	* IN
0469	15526	06/775	LDB RUND2	* INTERRUPT TABLE
0470	15527	017606	JSB INSWP	*
0471*				
0472	15530	06/763	LDB SWP1	*
0473	15531	006003	SZB,RSS	*
0474	15532	02/540	JMP SWAP2	* SET NEW I/O CHANNELS
0475	15533	044055	ADB .2	*
0476	15534	160001	LDA B,I	* IN EQUIPMENT TABLE ENTRIES
0477	15535	023774	XOR RUND1	*
0478	15536	033302	IOR GEND1	* OF DEVICES
0479	15537	170001	STA B,I	*
0480	15540	06/764	SNAP2 LDB SWP2	* SWAPPED
0481	15541	006003	SZB,RSS	*
0482	15542	027546	JMP SWPSC	* WITH RUN TIME DISC
0483	15543	023775	XOR RUND2	*
0484	15544	033303	IOR GEND2	*
0485	15545	170001	STA H,I	*
0486*				
0487	15546	063776	SNPSC LDA BURV#	
0488	15547	001200	RAL	
0489	15550	06/772	LDB BHMSK	
0490	15551	006003	SZB,RSS	← PACK BOOTSTRAPPED UP?
0491	15552	002004	INA	← YES! SET S.C. odd...
0492	15553	064155	LDB BSYSC	
0493	15554	070155	STA BSYSC	SET RUN TIME SYS SUBCHNL
0494	15555	054175	CPB BUDSC	
0495	15556	070175	STA BUDSC	
0496	15557	006400	CLB	
0497	15560	050175	CPA BUDSC	SYS SC = USER SC?
0498	15561	064115	LDB BSYBF	-YES,
0499	15562	074200	STB BDISCL	SET DISCL
0500	15563	047757	ADB .400	
0501	15564	074157	STB BUNTS	= SYSTEM NEXT IRK/SCTR
0502	15565	064175	LDB BUDSC	
0503	15566	074161	STB BDISC	
0504*				
0505	15567	124003	JMP JB,I	GO START DOS ← GO START SYSTEM
0506*				
0507	15570	000000	CNFGR NOP	
0508	15571	05/730	CPB DVADR	DONE CONFIGURING THIS DRIVER?
0509	15572	12/570	JMP CNFGR,I	-YES
0510	15573	03/730	ISZ DVADR	-NO, INCR TO NEXT INSTRUCTION
0511	15574	163730	LDA DVADR,I	LOAD INSTRUCTION
0512	15575	002021	SSA,RSS	*
0513	15576	02/571	JMP CNFGR+1	* CHECK IF INSTRUCTION
0514	15577	013766	AND MASK	* IS I/O
0515	15600	002002	SZA	* FOR DEVICE (EXCLUDING DMA)
0516	15601	02/571	JMP CNFGR+1	*
0517	15602	163730	LDA DVADR,I	-YES,

DOS-M DISC RESIDENT BOOTSTRAP

PAGE 0130 #10

0518	15603	043773	ADA CHANL	CONFIGURE INSTRUCTION
0519	15604	173730	STA DVADH,I	AND STORE
0520	15605	027571	JMP CNFGR,I	
0522	15606	000000	INSWP NOP	*
0523	15607	044045	ADB .6N	* THIS SUBROUTINE
0524	15610	044201	ADB BINT0	* IS USED TO SWAP
0525	15611	170001	STA B,I	* INTERRUPT TABLE ENTRIES
0526	15612	127606	JMP INSWP,I	*

DISC READ ROUTINE

0528	15613	000000	FLOAD NOP	
0529	15614	167762	LDB SPCAD,I	GET LOW CORE ADDRESS
0530	15615	037762	ISZ SPCAD	INCR CURRENT SPBUF ADDRESS
0531	15616	163762	LDA SPCAD,I	GET HIGH CORE ADDRESS
0532	15617	037762	ISZ SPCAD	INCR CURRENT SPBUF ADDRESS
0533	15620	003304	CMA,CCE,INA	COMPLEMENT, SET DIRECTION BIT
0534	15621	040001	ADA B	SET A = TOTAL WORD COUNT
0535	15622	005225	RBL,ERB	SET DIRECTION BIT IN CORE ADDR
0536	15623	106702	CLC 2	
0537	15624	100602	OTB 2	SET MEMORY ADDRESS REGISTER
0538	15625	167762	LDB SPCAD,I	GET DISK ADDRESS OF ABSOLUTE COD
0539	15626	037762	ISZ SPCAD	INCR CURRENT SPBUF ADDRESS

0541	15627	002021	SLOAD SSA,RSS	SKIP - MORE SECTORS TO LOAD
0542	15630	127613	JMP PLOAD,I	RETURN - THIS SECTION LOADED
0543	15631	043754	ADA P,128	ADJUST FOR NEXT COUNT
0544	15632	073761	STA RECNT	SET REMAINING COUNT
0545	15633	002020	SSA	SKIP - LESS THAN 128 WORDS
0546	15634	002400	CLA	
0547	15635	043753	ADA N,128	SET A = CURRENT SECTOR COUNT
0548	15636	102702	STC 2	
0549	15637	102602	OTA 2	SET WORD COUNT REGISTER
0550	15640	060001	LDA B	LOAD CURRENT DISK ADRS INTO A,
0551	15641	001767	ALF,CLE,ALF	ROTATE TO LU BITS,
0552	15642	013752	AND M,377	AND ISOLATE TRK#
0553	15643	102600	LSKA OTA 0	OUTPUT TRK#
0554	15644	103700	STC 0,C	TO DATA CHANNEL
0555	15645	063755	LDA SKCMD	LOAD SEEK COMMAND
0556	15646	033776	IOR BDRV#	INCLUDE DRIVE #
0557	15647	100701	CLC 1	
0558	15650	102601	OTA 1	OUTPUT SEEK/ADDRESS CMND
0559	15651	103701	STC 1,C	TO COMMAND CHANNEL
0560	15652	102300	SFS 0	CHECK DATA CHNL FLAG,
0561	15653	027652	JMP *-1	LOOP UNTIL SET
0562	15654	060001	LDA B	LOAD CURRENT DISK ADDRESS INTO A
0563	15655	013752	AND M,377	ISOLATE SECTOR#
0564	15656	043751	ADA #SPTN	ADD NEG #SCTRS/TRK
0565	15657	002021	SSA,RSS	CHECK IF SCTR# > #SCTRS/TRK
0566	15660	033757	IOR .400	-YES, SET LOWER HEAD#
0567	15661	002020	SSA	
0568	15662	043747	ADA #SPTK	-NO, ADD #SCTRS/TRK BACK IN
0569	15663	033772	IOR BHMSK	INCLUDE SYS HEAD# MASK
0570	15664	102600	OTA 0	OUTPUT HEAD/SECTOR
0571	15665	103700	STC 0,C	TO DATA CHANNEL
0572	15666	102301	SFS 1	CHECK CMND CHNL FLAG,
0573	15667	027666	JMP *-1	WAIT UNTIL SET

WAIT FOR SEEK

DOS-M DISC RESIDENT BOOTSTRAP

0574	15670	017714	JSB BSTAT ←	
0575	15671	063756	LDA RDCMD	LOAD READ COMMAND
0576	15672	033776	LOR BURV#	INCLUDE DRIVE#
0577	15673	102601	OTA 1	OUTPUT COMMAND FOR READ
0578	15674	103700	STC 0,C	
0579	15675	100701	CLC 1	
0580	15676	103706	STC 6,C	INITIATE DMA
0581	15677	103701	STC 1,C	INITIATE DATA TRANSFER
0582	15700	102301	SFS 1	CHECK CMND CHNL FLAG,
0583	15701	027700	JMP +=1	WAIT UNTIL SET
0584	15702	017714	JSB BSTAT ←	
0585	15703	060001	LDA B	LOAD CURRENT DISC ADDRESS INTO A
0586	15704	013752	AND M.377	AND ISOLATE
0587	15705	053750	CPA #SPCY	CHECK IF LAST SECTOR ON CYL
0588	15706	002001	RSS	-YES
0589	15707	002405	CLA,INA,RSS	-NO
0590	15710	063700	LDA #MASK	
0591	15711	044000	ADB A	INCR TO NEXT DISC ADDRESS (TRACK)
0592	15712	063761	LDA RECNT	GET REMAINING COUNT
0593	15713	027627	JMP SLOAD	LOAD NEXT NUMBER
0594*				SECTOR
0595	15714	000000	BSTAT NOP	
0596	15715	103700	STC 0,C	
0597	15716	063776	LDA BURV#	
0598	15717	106701	CLC 1	OUTPUT STATUS
0599	15720	102601	OTA 1	COMMAND
0600	15721	103701	STC 1,C	
0601	15722	102300	SFS 0	
0602	15723	027722	JMP +=1	
0603	15724	102500	DSKY LIA 0 ←	GET STATUS
0604	15725	000010	SLA	
0605	15726	102031	HLT 31B	
0606	15727	127714	JMP BSTAT,1	
0607*				DATA AREA
0608*				
0609	15730	015642	DVADR DEF DSKA-1	
0610	15731	015724	DEFDY DEF DSKY	
0611*				
0612	15732	015733	ASPF BF DEF ++1	
0613	15733	000000	BSS 12	CONTAINS 4 Entries (3 words each) for loading CRS.
0614*				
0615	15747	000000	#SPTK NOP	#SCTR/TRK (phys.cyl)
0616	15750	000000	#SPCY NOP	#SCTR/CYL - 1
0617	15751	000000	#SPTN NOP	NEG # SCTR/TRK (phys.cyl)
0618	15752	000377	P.377 OCT 377	
0619	15753	177600	N.128 DEC -128	
0620	15754	000200	P.128 DEC 128	
0621	15755	030000	SKCMD OCT 030000	SEEK COMMAND
0622	15756	020000	RDCMD OCT 020000	READ COMMAND
0623	15757	000400	.400 OCT 400	LOWER HEAD# BIT
0624	15750	000351	#MASK OCT 351	INCR. TRK# MASK
0625	15761	000000	RECNT OCT 0	CURRENT REMAINING COUNT
0626	15762	000000	SPCAD OCT 0	CURRENT DISK SPEC. BUFFER ADDR
0627*				
0628	15300		SPBF EQU 15300B	
0629	15302		GEND1 EQU SPBF+2	

STATUS SUBRTN.

DATA AREA

CONTAINS 4 Entries (3 words each) for loading CRS.

DOS-M DISC RESIDENT BOOTSTRAP

PAGE 0132 #10

0630	15303		GEND2	EQU	SPBF+3
0631	15304		EGCCK	EQU	SPBF+4
0632	15305		EGPCD	EQU	SPBF+5
0633	15310		GNTR	EQU	SPBF+8
0634	15311		EGDSK	EQU	SPBF+9
0635*					
0636	00053		#	EQU	538
0637	00045		.6N	EQU	#-6
0638	00051		.2N	EQU	#-2
0639	00052		.1N	EQU	#-1
0640	00055		.2	EQU	#+2
0641	00056		.3	EQU	#+3
0642	00060		.5	EQU	#+5
0643	00066		.17D	EQU	#+11
0644	00071		M.37	EQU	#+14
0645	00072		M.77	EQU	#+15
0646*					
0647	00100		#	EQU	100B
0648	00115		BSYBF	EQU	#+13
0649	00117		BEQTB	EQU	#+15
0650	00120		BEGT#	EQU	#+16
0651	00154		BDSCU	EQU	#+44
0652	00155		BSYSL	EQU	#+45
0653	00157		BLNLS	EQU	#+47
0654	00160		BSNLS	EQU	#+48
0655	00161		BCDSC	EQU	#+49
0656	00175		BLDSC	EQU	#+61
0657	00200		BDSCU	EQU	#+64
0658	00201		BINTB	EQU	#+65
0659*					
0660	15763	000000	SWP1	NOP	
0661	15764	000000	SWP2	NOP	
0662	15765	000031	DISK	OCT	31
0663	15766	070036	MASK	OCT	070036
0664	15767	177740	M.740	OCT	177740
0665*					
0666	15777		END	EQU	15777B
0667	15772		BPMASK	EQU	END-5
0668	15773		CFANL	EQU	END-4
0669	15774		KLND1	EQU	END-3
0670	15775		KLND2	EQU	END-2
0671	15776		BDRV#	EQU	END-1
0672*					
0673	15777		ORG		15777B
0674	15777	177733	ABS	ASPF-	*
0675*					
0676			END	DGEN	
**	NO ERRORS*				

BASE PAGE
COMMUNICATION
AREA LOCATIONS

HALTS IN DOS-M DURING SYSTEM OPERATION

T-REGISTER CONTENTS	PROGRAM LOCATION	CAUSE OF HALT	RECOVERY ACTION
102000	\$EX18	SYSTEM WAS UNABLE TO USE INTERRUPT TABLE TO MATCH CHANNEL # IN EQUIPMENT TABLE FOR GIVEN I/O REQUEST.	CHECK INTERRUPT TABLE ENTRIES AND PATCH IF POSSIBLE. REGENERATE CORRECT SYSTEM. IRRECOVERABLE HALT.
102004	DISCM	POWER UP OR DOWN WITH DOS-M SYSTEM IN CORE WITH P.F. OPTION PRESENT	BOOTSTRAP SYSTEM BACK UP FROM DISC AND RESTART.
102011	\$EX20	DISC PARITY ERROR. HALT OCCURS AFTER PRINTING MESSAGES ON SYSTEM TTY TO INFORM OPERATOR WHERE ERROR OCCURRED. (TRACK #, SECTOR #, AND SUB-CHANNEL #).	TURN ON "DISC PROTECT OVERRIDE SWITCH" AND PRESS "RUN" FOR SYSTEM TO ASSIGN NEXT SPARE TRACK.
102077	\$EX20	FOLLOWS MESSAGE TELLING OPERATOR TO TURN OFF "DISC PROTECT OVERRIDE SWITCH" AFTER SPARE TRACK ASSIGNMENT.	TURN OFF "DISC PROTECT OVERRIDE SWITCH" AND PRESS "RUN". SYSTEM ABORTS JOB THAT WAS RUNNING.
102031	DVR31	TRYING TO WRITE ON CYLINDER THAT HAS BEEN FLAGGED PROTECTED WITH "DISC PROTECT OVERRIDE SWITCH" OFF.	PRESS "RUN" TO EXIT DRIVER WITH NO ACTION TAKEN ON DISC.

DISC DUMP FOR DOSM GENERATION EXAMPLE

φ,φ	LB	DO	900φ	SY	ST	EM		
001	046102	042117	021450	051531	051524	042515	044456	031461
	020000	036173	000723	021456	031461	020000	036173	000724
	044456	031062	020000	036164	000000	041456	031062	020000
	036164	000000	046117	000000	001000	036164	000000	071373 CS.
	041120	051000	036146	000000	040523	046502	020000	036137
	000000	037501	051503	047000	036137	000000	037501	051515
	041000	036137	000000	037502	047103	047000	036137	000000
	037502	050113	052400	036137	000000	037503	044117	050000
	013000	000000	000312	044120	044400	036137	000000	037504
	041517	042000	036137	000000	037505	047104	051400	036137
	000000	037505	051120	051000	036137	000000	037515	051531
	051400	036137	000000	037507	042524	041400	036137	000000
	037515	047526	042400	036137	000000	037515	051531	046400
	036137	000000	037522	046125	047000	036137	000000	037501
	043114	043400	036137	000000	037514	051524	046000	036137
	000000	037514	052516	044400	036137	000000	037522	052502 CB
01	000000	067731	017570	067732	077762	017613	017613	017613
	017613	064120	007004	077310	064117	044055	160001	044051
	010072	073773	053774	077763	053775	077764	077304	044056
	160001	001727	013752	073305	050060	027460	053765	027440
	067304	044056	037310	027015	027505	044052	160001	023773
	033774	170001	063773	073302	002004	073303	063774	073773
	067304	160001	073730	164000	017570	063305	050060	027440
	006004	160001	033773	170001	006004	063747	170001	006004
	003004	170001	067304	077311	027440	060154	001722	013767
	033774	001727	001723	070154	063763	067302	017606	063764
	067303	017606	002400	067774	017606	063311	067775	017606
	067763	006003	027540	044055	160001	023774	033302	170001
	067764	006003	027546	023775	033303	170001	063776	001200
	067772	006003	002004	064155	070155	054175	070175	006400
	050175	064115	074200	047757	074157	064175	074161	124003
	000000	057730	127570	037730	163730	002021	027571	013766
02	002002	027571	163730	043773	173730	027571	000000	044045
	044045	170001	127606	000000	167762	037762	163762	037762
	003304	040001	005225	106702	106602	167762	037762	002021
	127613	043754	023761	002020	002400	043753	102702	102602
	060001	001767	013752	102600	103700	063755	033776	106701
	102601	103701	102300	027552	000001	013750	043751	002021
	033757	042020	043747	033772	102600	103700	102301	027666
	017714	063756	033776	102601	103700	106701	103706	103701
	102301	027700	017714	060001	013752	053750	002001	002405
	063760	044000	063761	027627	000000	103700	063776	106701
	102601	103701	102300	027722	102500	000010	102031	127714
	015642	015724	037733	000002	000732	011413	001634	007301
	000012	007361	007567	000411	007533	007567	006406	000014
	000427	177764	000377	177600	000200	030000	020000	000400
	000351	000000	000000	000000	000000	000031	070036	177740
	015771	046511	000000	000015	000015	000016	000000	177763
03	022105	054060	031401	000413	000002	007567	007624	000732
	000733	007567	007624	022105	054060	032001	000415	000004
	007567	010176	000732	000741	007567	010176	022105	054060
	007624	000421	000002	007567	007745	000732	000733	007567
	007745	022105	054060	033401	000423	000002	007567	007745
	007732	000733	007567	007745	022105	054060	034001	000421
	000002	007567	007732	000732	000733	007567	007732	022105
	054060	034401	000427	000003	007567	010142	000732	000763

SYSTEM LABEL / USER BOOTER SECTOR

DESC RESIDENT BOOTSTRAP

MEMORY BOUNDS & DESC ADDRESSES FOR C.R. SYSTEM

SYSTEM DIRECTORY

\$EX03
\$EX04
\$EX05
\$EX07
\$EX08
\$EX09

SYSTEM
DIRECTORY

007567	013142	022105	054061	030001	001002	000002	007567	\$EX10
007745	000732	000733	007567	007745	022105	054061	031001	
001004	000002	007567	007745	000732	000733	007567	007745	\$EX12
022105	054061	031001	001002	000002	007567	010023	000732	\$EX13
000754	007567	010023	007745	054061	032001	001012	000004	\$EX14
007567	010241	000732	000751	007567	010241	022105	054061	
032401	001016	000003	007567	010153	000732	000763	007567	\$EX15
010153	177777	000000	000000	000000	000000	000000	000000	

LAST DIRECTORY ENTRY THIS SECTOR

005	022105	054061	033001	001021	000002	007567	007732	000732	\$EX16
	000733	001002	007732	022105	054061	034401	001023	000003	\$EX19
	007567	010107	000732	001000	007567	010107	022105	054061	
	030001	001026	000003	007567	010167	000732	000761	007567	\$EX20
	010167	042126	051060	030404	001401	000003	010241	010555	DVR01
	001002	001022	010241	010555	042126	051060	031004	007745	DVR02
	000003	010241	010443	001002	001002	010241	010443	042126	DVR22
	051062	031004	001002	000003	010241	011005	001000	001002	
	010241	011075	046117	040504	051003	001414	000040	012000	LOADR
	021032	001002	001425	012000	021032	045117	041120	051003	
	002024	000046	012000	022463	001002	001414	012000	022463	JOBPR
	040523	046502	020003	003012	000027	012000	017120	001002	ASMB
	001362	016522	017120	040523	046502	042005	033411	000004	ASMBD
	017127	017647	001362	001363	017442	017647	040523	046502	ASMB1
	030405	003415	000006	017366	020542	001362	001424	017366	
	020542	177777	000000	000000	000000	000000	000000	000000	

LAST DIRECTORY ENTRY THIS SECTOR

006	040523	046502	031005	003423	000007	017345	020550	001362	ASMB2
	001410	017351	020550	040523	046502	031405	004002	000003	ASMB3
	017423	017771	001362	001363	017630	017771	040523	046502	
	032005	004005	000004	017366	020027	001362	001371	017366	ASMB4
	020027	040523	046502	032405	004011	000006	017345	020425	ASMB5
	001362	001404	017351	020425	043124	047060	020003	004017	FTN
	000006	012000	013127	001002	001047	012000	013127	043124	
	047060	030405	000025	000037	013254	022120	001047	001502	FTN01
	016550	022120	043124	000000	051005	005004	000031	013254	FTN02
	021027	001047	001356	013741	021027	043124	047060	031405	
	005405	000030	013254	020630	001047	001277	015117	020600	FTN03
	043124	047060	032005	006005	000031	013254	020750	001047	FTN04
	001360	013702	020750	045111	041122	054406	006407	000223	LIBRY
	000000	000000	000000	000000	000000	000000	000000	000000	
	000000	000000	000000	000000	000000	000000	000000	000000	
	000000	000000	000000	000000	000000	000000	000000	000000	

LAST DIRECTORY ENTRY

007	000000	000000	000000	000000	000000	000000	000000	000000	
	000000	000000	000000	000000	000000	000000	000000	000000	
	000000	000000	000000	000000	000000	000000	000000	000000	
	000000	000000	000000	000000	000000	000000	000000	000000	
	000000	000000	000000	000000	000000	000000	000000	000000	
	000000	000000	000000	000000	000000	000000	000000	000000	
	000000	000000	000000	000000	000000	000000	000000	000000	
	000000	000000	000000	000000	000000	000000	000000	000000	
	000000	000000	000000	000000	000000	000000	000000	000000	
	000000	000000	000000	000000	000000	000000	000000	000000	
	000000	000000	000000	000000	000000	000000	000000	000000	
	000000	000000	000000	000000	000000	000000	000000	000000	
	000000	000000	000000	000000	000000	000000	000000	000000	
	000000	000000	000000	000000	000000	000000	000000	000000	
	000000	000000	000000	000000	000000	000000	000000	000000	
	000000	000000	000000	000000	000000	000000	000000	000000	
	000000	000000	000000	000000	000000	000000	000000	000000	
	000000	000000	000000	000000	000000	000000	000000	000000	
	000000	000000	000000	000000	000000	000000	000000	000000	
	000000	000000	000000	000000	000000	000000	000000	000000	
	000000	000000	000000	000000	000000	000000	000000	000000	
	000000	000000	000000	000000	000000	000000	000000	000000	

not
used

CRS₂

DISCM

070241	127736	000000	003000	040254	002020	037746	127746
034105	027761	063775	070105	034104	060106	002020	027714
034107	027714	063775	070107	034106	060108	050110	124631
027714	176650	170217	070531	174200	017331	060513	003004
050203	070513	060202	000010	034030	050101	002003	000070
160212	002020	003004	050054	002001	026070	007400	044111
044121	003400	140001	114632	040117	050203	002001	026070

011

012	160214	160000	010075	150633	002001	026070	160211	114634
	026070	060123	072052	160214	066207	017361	002052	160220
	164215	006001	026061	002004	001100	070530	160206	012211
	170206	160211	070242	026651	160217	002002	026152	160206
	012211	170206	160213	012210	002002	026163	160211	070505
	164220	114634	026150	164635	154636	026204	060260	002003
	026143	003400	140121	114630	040117	040056	160000	002020
	026143	052212	002002	026141	160206	070237	164220	074240
	160211	070242	006400	074260	027426	006400	074260	164220
	160206	102100	102705	124505	160206	124505	050056	002301
	026641	160206	110637	150640	026644	060056	026641	063213
	002003	026171	064513	002021	027256	160205	010072	053204
	027244	063220	002003	124554	017003	027271	124554	027271
	060203	072213	027244	177734	020000	037777	000000	000000
	000000	103100	114641	052214	040052	002001	102505	070512
	070242	072424	036424	160000	012473	052475	002001	026633

012

013	160512	012474	160000	052476	002001	026315	066424	160001
	114634	026635	160001	070225	007004	040001	002003	026635
	040052	070204	002020	026635	040042	002021	026635	064043
	002400	017301	000226	004224	007004	030424	062266	070505
	162424	014507	170505	034505	036424	006006	026274	160226
	052500	002001	026325	114642	170001	006004	102100	102705
	124225	052477	026320	026633	114642	114577	000000	134532
	124643	002000	026635	052501	124534	052502	026346	052503
	026340	052504	026425	026352	060237	072342	000000	026312
	034105	026312	060103	002003	026344	032505	072357	060103
	032506	072360	060056	000000	000000	026312	002021	003004
	042461	002020	026635	160226	002020	003004	070514	050064
	026400	050065	002001	026402	060063	070514	050060	026312
	042436	160000	050052	026635	052437	026431	070474	062462
	070475	002404	064514	154475	027020	002004	034475	026417
	000000	160644	070474	060056	027020	006400	160645	070474

013

014	062470	027020	002436	002431	002431	002431	100612	177777
	100605	100606	100607	100607	100607	100611	177777	002431
	002431	002431	100603	100604	100610	000022	002453	000020
	000021	000006	000007	000010	000022	000013	000004	176000
	001777	114000	002214	004243	177755	177754	177753	177752
	000027	102500	103700	000000	002003	026635	050054	026635
	001275	002001	126507	160000	025510	140646	070514	060232
	070472	066552	074473	160647	070474	062471	027020	006003
	026665	060514	050055	002001	026432	060001	040055	160000
	010071	050065	026432	052471	026432	026631	002533	000000
	010072	002003	026653	007400	044000	003004	040122	002020
	026653	044121	160001	002003	026655	040052	114632	040117
	017345	126553	000000	164226	174212	006020	007004	060225
	170211	160227	050050	003004	170213	050230	054056	160230
	170214	160231	170215	060232	154650	026625	154651	026625
	160232	170216	160233	170217	126576	006400	026670	064054

014

015	026670	054055	026670	064056	026670	064057	070473	026670
-----	--------	--------	--------	--------	--------	--------	--------	--------



CRS₂

CRS

DISCM

007400	170206	016776	164652	026670	164653	026670	064060
026670	064061	026670	064062	026670	064063	026670	064064
026670	064065	000512	002001	000242	070472	002400	070245
160654	070474	160653	027020	000000	160205	002021	006723
000001	070205	017000	026701	000000	160205	110007	150040
026717	034257	026721	060060	026774	060203	170001	160213
010077	070001	160212	002020	003004	150650	026740	150651
026742	030001	170213	026744	002404	026735	060055	026735
160205	010072	160203	114001	020510	002102	026766	160205
001222	000010	026762	000513	003004	070513	160206	130655
170205	126700	000056	002307	017331	000440	016776	000510
036700	126700	000000	060526	002003	126776	124000	000000
064201	002400	150001	027017	060165	002002	027016	006004
150001	037003	037003	127003	073116	077115	060243	070477
060244	002003	124474	003004	070500	000245	002020	027222
016 053116	027110	160477	000000	053116	027047	034477	034477
034500	027036	124474	003004	070245	064246	074167	007004
044247	074170	160477	001722	010071	034477	164477	074166
036212	002003	027106	001722	001222	070001	003004	040170
002021	074170	017117	060174	070166	064250	074167	007004
044251	074170	017117	072212	067115	063116	003004	070245
124246	000000	000000	000000	060100	017100	063127	006404
017400	002400	127117	000166	000000	006400	114577	177770
060154	010074	003004	044000	006021	026663	127130	000000
070513	064252	074167	007004	140650	144000	074170	040055
160000	070166	017117	060174	070166	064253	007004	000513
140651	144000	006003	127143	060253	070167	036212	074170
017117	072212	100143	070000	072206	000200	073205	027244
000000	000000	000000	000000	060203	073213	027244	000000
073221	060203	073220	027244	000000	000000	037236	063115
073240	063116	073237	060474	073241	060472	073242	060473
017 073243	027244	000000	000000	000000	000000	000000	000000
063204	002003	007256	160205	001222	010000	002002	027256
073204	127206	063213	002003	027271	060513	002020	027271
063213	017345	002400	073213	127207	063220	002003	027304
017003	027277	027304	063220	017345	002400	073220	127221
063236	002003	027325	060245	002020	027325	002400	073236
063242	070472	063243	070473	063241	070474	063237	067240
027020	100100	003400	007400	027325	000000	064201	060203
150001	027342	006004	150001	002001	127331	002400	170001
127331	000000	067360	074474	067357	170001	002004	006004
034474	027351	127345	000203	177757	000000	070503	074505
167361	074504	037361	006400	002002	164503	174504	034503
034504	034505	027367	127361	000000	077412	064203	077423
073424	060055	073413	063424	073414	114545	000000	000000
003414	000000	003420	027244	063423	017345	127400	000000
000000	000000	077561	017563	034261	067561	063556	006002
017 063553	073441	114545	000002	000001	003441	000002	003463
063561	002002	027244	060520	114634	027244	060517	103101
000035	100101	060515	064515	100100	100205	124520	017563
060123	073471	114545	000001	000401	003471	000044	003475
027444	077562	017563	002400	070261	067562	017575	060471
150656	027430	150657	027430	027444	060111	050054	027544
073532	064123	077533	016553	160205	001222	000010	027530
060203	050513	002001	017143	114545	000001	003532	003533
000044	003537	027244	160123	010075	150633	017575	027511
060261	002003	027551	034260	027244	007400	027426	003554

DISCM

006412	040137	003557	006412	025137	000000	000000	000000
060237	070515	060240	070516	060241	070517	060242	070520
127563	000000	074530	074472	067575	074473	064123	160001
010075	150033	027631	034261	114545	000002	000001	004140
177770	003605	064471	104000	027001	000520	114634	124004
027452	002410	070261	017563	127575	160001	006004	164001

0.18

010	114577	177770	170635	064471	154660	027677	150661	124662
150636	124663	150664	124665	150666	124662	154656	002001	
027702	150665	004401	027714	074471	062213	002002	027670	
160667	070474	062463	027020	070213	150656	027447	017345	
160211	070505	026141	150660	027743	027607	154657	027736	
006002	027607	064262	004010	027714	064141	006003	027743	
150670	027731	150671	027725	150672	027731	150673	027731	
027607	160674	070474	060004	027020	160675	070474	160650	
064530	027020	150657	027743	150676	027743	027607	002400	
114556	002400	070260	160677	070141	160700	070142	160701	
070143	060263	070166	060254	070167	060264	070170	017117	
060174	070166	060255	070167	060265	070170	002400	070471	
017117	002400	070261	070260	064530	070530	102100	102705	
124254	060112	070111	006400	074475	060106	032150	070106	
016044	070262	070245	067276	070474	064475	052313	124540	
064242	074475	062106	000471	104702	070471	170703	124544	

CRS₂

0.19

020	000000	060141	002003	124704	060262	032150	070262	124705
000000	060120	003004	070474	074475	064117	044055	160001	
010072	032141	072076	000004	160001	001265	012304	052305	
002041	024073	002072	040006	170001	124706	004045	052153	
032152	170001	107700	100007	034474	006003	102106	107706	
102107	107707	064201	002400	170001	070513	170710	170711	
170712	170713	070261	070260	170703	006004	170001	126044	
040502	050101	043517	045117	042512	046125	042521	052520	
042116	042101	052131	047506	044507	047117	051105	042040	
107700	045117	041120	051040	160000	035000	000040	000400	
062271	070474	060005	124540	106700	062273	070474	062310	
124540	000000	062165	002004	160000	114565	160206	001222	
010056	002003	026204	007400	046165	160205	010072	124553	
160206	012304	052305	002001	026217	114714	026217	003401	
003400	042165	124506	162165	002021	003004	170212	030165	
162165	170213	035165	162166	170214	036165	162165	170215	

0.20

021	036165	162165	170211	036165	114572	126165	026240	000000
072260	162243	072261	062260	036243	000066	005600	002040	
002004	036261	026251	126243	000000	000000	000000	070001	
001700	040001	126262	000470	100613	100614	100615	100616	
100617	100620	100621	100622	100623	100624	100625	100626	
037400	014400	177764	177763	000014	000015	000016	000017	
060224	040047	002002	026373	060231	114715	160226	002020	
026353	060150	006400	114577	177770	002002	006004	007004	
144230	005021	026341	006400	026365	006400	060154	010074	
003000	140227	140230	002003	026363	002021	026365	164230	
144227	007004	060154	010074	002004	040001	002020	026337	
164230	174231	002000	070000	102100	102705	124225	002400	
070245	124541	060224	040047	002002	026443	060227	114715	
060230	114715	060231	114715	060160	006400	114577	177770	
002002	006004	174227	060102	002003	026431	006400	114577	
177770	002002	044002	074000	026433	000154	010074	170230	

\$EX01

\$EX02

0.21

022	060115	170231	002400	070245	102100	102705	124225	002400
070245	124541	060000	040224	002002	026502	060230	114715	

\$EX06

064227	034162	060200	002004	114716	026477	064227	060114	\$EX06
114716	026477	002400	170230	002400	070245	044052	160001	
102100	102100	124225	044052	100001	026467	002400	070245	
124541	060472	072664	060473	072664	060200	052666	026537	
060202	002002	034162	002004	114716	026477	002004	002004	
066647	076641	062664	114717	026614	066641	044063	076641	
056663	026505	026526	062664	066577	114717	026596	062664	
066573	114717	026562	034162	060200	002004	066664	114716	
026567	006401	008577	000400	070245	126668	060573	064046	
114543	000200	066647	076641	060577	064046	114543	000133	\$EX11
062664	064046	114543	000133	000556	000400	066667	114543	
000270	034162	060200	002004	066664	114716	026630	026555	
066641	044060	160001	070161	006004	160001	070157	006004	
160001	070200	066641	026567	076664	062663	040043	052647	
023	026644	072641	040043	064043	114543	000000	062641	026632
062664	064046	114543	000270	060161	070275	060157	070276	
060200	070277	062670	172663	034525	066647	026567	000460	
000000	000000	177765	177607	022124	026707	062771	002020	
026772	062704	006002	062705	070473	017250	064057	027051	
047122	059100	004672	060161	073261	060200	073262	064224	
044047	006020	026724	160231	050054	027074	002024	027120	
062705	070020	000106	003000	006001	160230	072771	002020	
027013	070161	017215	017126	063030	114721	026747	064227	
017200	027025	027101	160227	002003	027043	010075	053000	
027101	027043	062771	003000	070161	017215	063030	114721	
027001	064227	017200	026772	027006	000000	036771	026756	
063162	066777	027045	177766	025000	160227	010075	053000	
027000	026772	000202	000000	017230	017126	027101	160227	
002002	026756	072771	017230	017215	017126	063030	114721	
027043	063031	064041	027045	005034	005032	046102	046075	
024	000000	000000	000000	000040	052516	046102	046040	063037
064046	114722	017250	064055	047154	002400	073154	070526	\$EX17
070245	160000	070474	060057	124540	006400	074245	074526	
063154	002002	027050	063263	102100	102705	124225	005046	
160230	070161	063073	070526	017215	006400	077263	074126	
074133	067177	017200	027115	006404	060370	070200	063227	
114720	064370	074157	027061	070245	160601	070474	063125	
124540	000023	000000	060176	050272	027136	070472	060272	
070473	037154	060271	053105	127126	007161	053156	067167	
057161	063160	073164	077165	063163	064043	114722	127126	
000000	042117	052123	041040	037477	037440	005166	005164	
000000	000000	042111	051503	020116	047524	020117	047040	
051531	051524	042515	005174	000000	160001	050273	000005	
127200	160001	050274	006005	127200	160001	050275	037200	
127200	000000	006400	060161	060155	064115	074200	063227	
006404	114720	127215	000200	000000	060161	033241	001727	
025	073247	063242	054042	114722	127230	000060	005243	051525
041103	044101	047075	000000	000000	063261	070161	063262	
070200	060074	070163	073263	127250	000000	000000	000000	
006002	027700	160227	064161	077314	050050	003004	114660	
060514	053313	002001	027335	017766	160206	170230	064224	\$EX18
054056	027310	164220	174231	102100	102705	124225	000015	
000000	000010	040201	040045	073766	164000	006003	027331	
044055	160001	010072	053334	002001	037315	060203	127315	
000000	160205	010072	073334	017315	027356	063334	002004	
017315	027356	060001	017315	027356	060002	017315	027356	
102000	027354	060004	160001	064514	054056	027411	001222	

010056	002003	027411	050054	027402	050055	027376	063375
124566	005266	017766	063334	064512	124553	060512	070470
063410	070471	017766	124544	043517	063334	017315	173766
063334	002004	017315	173766	160200	001222	000010	027427
064513	004000	114552	064514	000054	027435	050055	007435
026	027443	160227	050050	003004	010072	050056	034102
160226	002021	027462	160206	013456	053457	027565	027667
017766	124574	037400	014400	000016	000017	000014	050056
027667	004230	007000	044234	000021	124561	017766	044230
002040	124562	007004	044100	000020	124562	160200	013456
053457	002001	027667	060514	063460	027454	053461	027454
060102	002003	027523	001727	010074	040052	027525	060154
010076	070535	060160	006400	114577	177770	002002	006004
160232	010074	170232	003000	040001	002021	124563	063765
006400	114577	177767	002002	006004	144233	002400	044511
006020	027560	002004	027553	140232	003004	040505	002000
124563	160233	040511	002021	124563	160232	001727	130233
070171	060230	070172	160231	070173	060224	040045	002002
124560	050255	114565	114571	064177	160227	050050	074161
063753	170214	114570	027054	067314	074161	050050	027642
050055	027650	050056	002001	027645	060203	070472	160600
027	070474	017765	067641	060057	124540	000022	063644
005616	050057	002001	124573	017766	160206	006400	027310
017766	063314	070161	160227	050050	003004	013666	002003
124551	027310	020000	160205	001222	000010	027015	060203
050513	027615	114570	027016	160233	003004	067764	074504
044057	140001	070000	017766	000161	073314	006400	063765
114577	177747	006002	002004	003004	040505	002020	124564
064504	044056	160001	006400	114577	177770	077756	001727
140233	070505	040511	002020	027744	037756	070505	027736
067756	005727	060505	030001	070171	034162	027075	000171
000126	000000	000000	164231	005121	027764	005100	007004
077756	127705	000000	000245	002020	003004	070245	127705
000000	003000	070001	040254	002021	026006	044100	006020
026006	124723	002400	070245	124541	000000	072125	076126
060161	072107	060162	072123	002400	070162	072130	060115
040075	064055	010252	016135	062123	002003	026114	064527
028	056057	026111	006020	026000	004005	006043	026111
002041	026054	062130	052107	026054	016202	026054	016136
036130	066131	026040	047117	060156	003000	072130	062130
003000	052107	026072	016202	026072	016136	036130	026063
026111	062124	066110	114543	006123	000161	052107	026115
002400	070126	026115	000000	177765	062107	016202	000000
036011	060115	040075	006404	016252	066100	126011	000000
000000	000000	000000	000000	000000	000000	000000	000000
000000	000001	000000	062125	016244	062264	072124	062126
066124	016265	026075	066124	044055	160001	010073	040045
002020	044051	044056	076124	007000	144546	006020	026172
162124	002003	126136	050052	002001	026143	036125	062125
010073	003004	040116	002002	026137	126136	000000	070161
060074	070163	062237	070526	002400	070200	016244	062241
050273	050274	052242	060275	052243	002001	026226	060370
070200	016244	060370	070157	060200	002004	072125	036202
029	002400	070526	126202	006240	026234	051531	051524
000000	066123	074162	006404	016252	126244	000000	070160
052264	070147	062263	070170	062265	114536	126252	000200

\$ADDR

\$SRCH

000270	044166	040000	072127	160001	152127	002001	026313
006004	036127	160001	152127	002001	026313	006004	036127
162127	010075	072127	160001	010075	052127	002001	036266
126266	000000	062327	072334	003400	066370	120001	006004
036337	026327	126315	177343	000000	076334	064050	114543
000000	126330	000000	064000	062352	016330	060270	052353
002001	126336	016315	050327	036336	126336	000273	046102
000000	070170	076334	064200	074166	062370	070167	062371
066334	034162	114536	126354	000270	000166	000000	072401
076402	034261	114545	000002	000001	000000	000000	006405
124551	000000	070261	126320	06643	150213	052577	026436
026431	032633	002311	001425	102600	016446	000015	016464
102700	002400	170220	126410	006424	120213	052577	026436
LS							
030	060057	126410	164214	006021	007004	174217	005300
	060055	026415	000000	164214	005200	174216	164215
	005010	007004	001310	026462	006003	007400	174217
	000000	062464	052430	026476	160206	002020	026476
	036464	126464	164213	005332	026611	102500	010073
	026541	052422	026537	050065	026562	006020	026537
	026544	164216	004065	134216	002041	001727	072446
	002340	001707	110001	032446	170001	160213	001421
	000000	001405	170213	036464	026606	016446	160213
	016553	044052	174216	160217	040052	170217	026537
	160214	001000	150216	026537	164216	126553	005421
	016553	004065	160001	010075	032534	002040	170001
	164215	002004	000021	001100	006020	007300	044000
	001521	102600	103700	002400	126464	062464	052430
	102500	010074	050074	006003	002400	002400	150216
	150217	026645	160216	134216	000065	004010	062630
031							
	006051	001727	010074	134217	026643	052657	026574
	026537	062422	150220	060065	170220	052422	026643
	174216	026643	004000	000137	007332	064162	060155
	060161	073350	000065	073347	002441	063344	073352
	006002	062163	073353	063347	017211	000400	010067
	026737	160213	010056	001510	026714	067145	063336
	063337	002341	026726	160213	010077	001225	053340
	060057	126660	067332	077062	073346	060041	170220
	072743	026764	006737	060056	006400	074162	126660
	063347	106001	006003	026755	002400	004033	026755
	026751	017211	027115	067333	106606	164217	124001
	164214	006004	160001	002003	027071	073354	006004
	002021	003005	001100	002003	003400	073355	044051
	010075	073300	120001	073351	003004	040116	001727
	043355	002020	027034	001727	001200	010074	003004
	050116	062701	043350	070174	002400	006004	170001
032							
	044055	003004	170001	043355	073355	044052	003004
	170001	044052	063350	042701	170001	017126	017241
	063346	053336	047343	106702	106602	067355	000000
	017241	063346	053337	017172	026764	060200	002302
	060162	067053	002041	002003	074164	002041	002002
	002400	070162	164215	006020	007004	126743	000000
	170217	002400	036743	126743	000000	033347	106701
	103701	127120	000000	063351	043335	002021	032701
	043334	033352	070001	063350	001767	017143	127126
	102600	103700	053353	002300	073353	063341	001225
	102300	027154	106600	103700	017112	127140	000000
	106602	103706	017120	106706	017112	127162	000000

\$LBL

DVR05

DVR31

LS

LS

063355	003004	040073	001727	001200	010071	102600	103700
063342	017120	017112	017241	127172	000000	102106	103700
100701	102601	100701	100700	027217	100500	073357	010074
073356	003007	001205	002440	027207	100000	010075	033356
033	170206	037211	127211	070525	127211	000000	063357
	127241	001422	001727	000010	027262	001723	000312
	057340	127241	134220	027276	001200	002021	002405
	006400	074102	067360	074126	067351	074130	067350
	005727	126743	063252	006500	017143	002400	006500
	027001	001332	027315	067346	073336	027204	027313
	027104	017126	067345	106702	106602	063336	007400
	017162	063350	010075	073350	034525	027051	102100
	000000	000000	020000	010000	110400	030000	060000
	001000	107300	000000	000000	000000	000000	000000
	000000	000000	000000	000000	000000	000000	000000
	000000	000000	000000	000000	000000	000000	000000
	000000	000000	000000	000000	000000	000000	000000
	000000	000000	000000	000000	000000	000000	000000
	000000	000000	000000	000000	000000	000000	000000
	000000	000000	000000	000000	000000	000000	000000
	000000	000000	000000	000000	000000	000000	000000

CRS 2

NOT USED

034	006410	006403	040011	002400	000000	000000	000000
	000000	000000	000000	000000	000000	000000	000000
	000000	010241	010313	000013	000440	000000	000000
	000000	000000	000000	000000	000000	000000	000000
	001000	001401	006660	006743	100014	014400	000000
	000000	000000	000000	000000	000000	000000	000000
	000000	000000	000000	010241	010313	000010	001000
	000000	000000	000000	000000	000000	000000	000000
	000000	010443	001002	001404	010241	011001	100022
	000000	000000	000000	000000	000000	000000	000000
	000000	000000	011075	001002	001407	000001	000003
	000004	000002	000001	000005	000006	000007	000000
	000000	007402	000000	007403	007444	000000	000000
	000000	007455	000000	000000	000000	000000	000000
	000000	000000	000000	000000	000000	000000	000000
	000000	000000	000000	000000	000000	000000	000000
	000000	000000	000000	000000	000000	000000	000000
	000000	000000	000000	000000	000000	000000	000000
	000000	000000	000000	000000	000000	000000	000000
	000000	000000	000000	000000	000000	000000	000000
	000000	000000	000000	000000	000000	000000	000000
	000000	000000	000000	000000	000000	000000	000000
	000000	000000	000000	000000	000000	000000	000000

EQUIPMENT TABLE
CRS 3

DEVICE REF.
INT. TABLES
CRS 3

NOT USED

035	030400	060175	050221	001200	000130	100001	002003
	072000	001600	040000	001077	103330	072000	001647
	001300	066000	001276	016000	000063	062002	133320
	001432	100000	001250	072000	001443	026000	000000
	002000	000400	001301	020102	042507	044516	000000
	042105	041125	043447	020117	000000	050105	051101
	047516	030000	000000	000000	000000	000000	000000
	000000	000000	000000	000000	000000	000000	000000
	000000	000000	000000	000000	000000	000000	000000
	000000	000000	000000	000000	000000	000000	000000
	000000	000000	000000	000000	000000	000000	000000
	000000	000000	000000	000000	000000	000000	000000
	000000	000000	000000	000000	000000	000000	000000
	000000	000000	000000	000000	000000	000000	000000
	000000	000000	000000	000000	000000	000000	000000
	000000	000000	000000	000000	000000	000000	000000
	000000	000000	000000	000000	000000	000000	000000
	000000	000000	000000	000000	000000	000000	000000
	000000	000000	000000	000000	000000	000000	000000
	000000	000000	000000	000000	000000	000000	000000

NOT USED

START DRS

036	060105	002000	027604	033622	070100	060113	002011
	002400	070245	070530	006404	124550	067623	002400
	070471	114543	000141	114556	006400	060262	074262
	124537	007400	124544	100000	177765	000000	000000

\$EX03

DRS

000000	000000	000000	000000	000000	000000	000000	000000
000000	000000	000000	000000	000000	000000	000000	000000
000000	000000	000000	000000	000000	000000	000000	000000
000000	000000	000000	000000	000000	000000	000000	000000
000000	000000	000000	000000	000000	000000	000000	000000
000000	000000	000000	000000	000000	000000	000000	000000
000000	000000	000000	000000	000000	000000	000000	000000
000000	000000	000000	000000	000000	000000	000000	000000

1.14

0614051	041224	002002	027647	060227	070475	114715	006400
063744	040105	002002	027607	170475	034475	170475	027622
017652	000045	070474	074000	001723	040001	040001	170475
034475	060474	170475	034475	006400	060104	002002	027633
170475	034475	170475	027640	017652	007745	174475	034475
170475	034475	002400	170475	070245	102100	102705	124225
002400	070245	124541	000000	077735	167652	164001	037602
006003	027733	006120	007204	077736	007004	077737	067740
077741	064051	077742	077743	067735	006021	027703	037743
007200	002002	003805	006004	002040	037742	047737	006021
027733	047736	000066	005600	047737	006021	002005	047736
037741	027711	003006	002020	002001	027733	103101	037742
003004	037743	127652	007005	102101	127652	000000	000000
000000	177760	000000	000000	000000	001130	000074	000000
000000	000000	000000	000000	000000	000000	000000	000000
000000	000000	000000	000000	000000	000000	000000	000000

\$EX07

D.P. LINK FOR \$EX07

007567	000000	000000	000000	000000	000000	000000	000000
000000	000000	000000	000000	000000	000000	000000	000000
000000	000000	000000	000000	000000	000000	000000	000000
000000	000000	000000	000000	000000	000000	000000	000000
000000	000000	000000	000000	000000	000000	000000	000000
000000	000000	000000	000000	000000	000000	000000	000000
000000	000000	000000	000000	000000	000000	000000	000000
000000	000000	000000	000000	000000	000000	000000	000000
000000	000000	000000	000000	000000	000000	000000	000000
000000	000000	000000	000000	000000	000000	000000	000000
000000	000000	000000	000000	000000	000000	000000	000000
000000	000000	000000	000000	000000	000000	000000	000000
000000	000000	000000	000000	000000	000000	000000	000000
000000	000000	000000	000000	000000	000000	000000	000000
000000	000000	000000	000000	000000	000000	000000	000000
000000	000000	000000	000000	000000	000000	000000	000000
000000	000000	000000	000000	000000	000000	000000	000000
000000	000000	000000	000000	000000	000000	000000	000000

NOTE:
 - Lines 1-4
 - 5th SINC
 - \$ADDR
 - Core 3
 - No. 1000
 - None

1.21

060224	040006	002002	027714	060230	114715	060231	114715
060232	114715	060267	002002	027613	060160	006400	114577
177770	002002	076004	074267	160227	001665	040267	070001
060100	001727	010074	002003	060154	010076	007004	040001
002021	027701	034261	114545	000002	000001	007720	177750
007641	124551	002400	070261	160227	002021	027655	003400
170230	002400	070245	102100	102705	124225	060113	006400
074245	002020	027677	063717	064111	054054	002400	070471
114555	006400	060262	074262	002021	124537	007400	124540
006400	124550	060267	170230	164227	005665	040001	071207
060005	170231	060116	170232	027650	002400	070245	124541
045117	021440	052122	040503	045523	020125	047101	053100
044514	040502	046105	000000	000000	000000	000000	000000
000000	000000	000000	000000	000000	000000	000000	000000

\$EX08

DRS

1.22

BASE PAGE LINK FOR \$EX08

007567	000000	000000	000000	000000	000000	000000	000000
000000	000000	000000	000000	000000	000000	000000	000000
000000	000000	000000	000000	000000	000000	000000	000000
000000	000000	000000	000000	000000	000000	000000	000000
000000	000000	000000	000000	000000	000000	000000	000000
000000	000000	000000	000000	000000	000000	000000	000000
000000	000000	000000	000000	000000	000000	000000	000000
000000	000000	000000	000000	000000	000000	000000	000000
000000	000000	000000	000000	000000	000000	000000	000000
000000	000000	000000	000000	000000	000000	000000	000000
000000	000000	000000	000000	000000	000000	000000	000000
000000	000000	000000	000000	000000	000000	000000	000000
000000	000000	000000	000000	000000	000000	000000	000000
000000	000000	000000	000000	000000	000000	000000	000000
000000	000000	000000	000000	000000	000000	000000	000000
000000	000000	000000	000000	000000	000000	000000	000000
000000	000000	000000	000000	000000	000000	000000	000000
000000	000000	000000	000000	000000	000000	000000	000000
000000	000000	000000	000000	000000	000000	000000	000000
000000	000000	000000	000000	000000	000000	000000	000000
000000	000000	000000	000000	000000	000000	000000	000000
000000	000000	000000	000000	000000	000000	000000	000000
000000	000000	000000	000000	000000	000000	000000	000000
000000	000000	000000	000000	000000	000000	000000	000000
000000	000000	000000	000000	000000	000000	000000	000000
000000	000000	000000	000000	000000	000000	000000	000000
000000	000000	000000	000000	000000	000000	000000	000000
000000	000000	000000	000000	000000	000000	000000	000000
000000	000000	000000	000000	000000	000000	000000	000000
000000	000000	000000	000000	000000	000000	000000	000000
000000	000000	000000	000000	000000	000000	000000	000000

1.23

064123	060866	174735	060473	170736	002400	170737	114740
114740	114740	114740	150741	002001	027627	114740	010070
170737	114740	150742	027625	150741	027757	010070	170743
160737	001723	140737	140737	140743	170737	007400	027633
002404	170737	064120	007404	174744	160737	003004	040120
002420	027757	160737	114733	073775	160737	040052	070401
001720	040001	040117	040055	170745	160000	010072	114734
170746	160747	001727	001222	010062	114733	010074	130750
001727	170751	164752	160747	002020	164753	174754	164752
160747	001222	004010	164755	174756	134745	160747	001222
010056	114734	010074	130757	170760	160747	001727	010074
114734	170751	034261	114545	000002	000001	007773	177744
007746	060520	003000	040254	002021	124554	060517	103101
000036	102101	060515	064516	102100	102705	124520	002400
070261	114555	134737	134744	027634	002400	070245	124762
034261	114545	000002	000001	010011	177764	007767	027730

\$EX09

2.0

042400	070261	114555	027754	042521	052040	000000	020103
044040	000000	020104	053122	000000	000000	000000	020125
000000	000000	044516	050125	052040	042522	051117	051040
000040	020000	051400	000000	066037	004065	160001	002041
001727	010074	005600	006004	076037	126022	000000	000000
000000	000000	000000	000000	000000	000054	020460	020104
020122	000000	064041	016060	126050	000000	064043	015060
126054	000000	076141	066117	076113	076114	076115	066112
076116	016120	146116	176116	002003	026104	016120	005727
146116	176116	036116	002002	026070	066115	062113	072115
076113	066112	126060	010113	000000	000000	000000	000000
030360	000000	006400	076140	070061	042141	036140	002021
026123	006020	026124	066141	007004	044000	062140	040052
126120	000000	000000	000000	000000	000000	000000	000000
000000	000000	000000	000000	000000	000000	000000	000000
000000	000000	000000	000000	000000	000000	000000	000000

ASCIT

2.1

007567	010050	010054	010037	010036	010042	010022	010044
110017	010041	010043	010040	010000	110040	010020	010047
010045	010046	010004	010047	010005	010021	010010	010003
110036	000000	000000	000000	000000	000000	000000	000000
000000	000000	000000	000000	000000	000000	000000	000000
000000	000000	000000	000000	000000	000000	000000	000000
000000	000000	000000	000000	000000	000000	000000	000000
000000	000000	000000	000000	000000	000000	000000	000000
000000	000000	000000	000000	000000	000000	000000	000000
000000	000000	000000	000000	000000	000000	000000	000000
000000	000000	000000	000000	000000	000000	000000	000000
000000	000000	000000	000000	000000	000000	000000	000000
000000	000000	000000	000000	000000	000000	000000	000000
000000	000000	000000	000000	000000	000000	000000	000000
000000	000000	000000	000000	000000	000000	000000	000000
000000	000000	000000	000000	000000	000000	000000	000000
000000	000000	000000	000000	000000	000000	000000	000000
000000	000000	000000	000000	000000	000000	000000	000000
000000	000000	000000	000000	000000	000000	000000	000000
000000	000000	000000	000000	000000	000000	000000	000000
000000	000000	000000	000000	000000	000000	000000	000000
000000	000000	000000	000000	000000	000000	000000	000000
000000	000000	000000	000000	000000	000000	000000	000000
000000	000000	000000	000000	000000	000000	000000	000000
000000	000000	000000	000000	000000	000000	000000	000000

BASE PAGE LINKAGES FOR \$EX09

DRS

000000	000000	000000	000000	000000	000000	000000	000000
000000	000000	000000	000000	000000	000000	000000	000000
000000	000000	000000	000000	000000	000000	000000	000000
000000	000000	000000	000000	000000	000000	000000	000000
000000	000000	000000	000000	000000	000000	000000	000000
000000	000000	000000	000000	000000	000000	000000	000000
000000	000000	000000	000000	000000	000000	000000	000000
000000	000000	000000	000000	000000	000000	000000	000000
000000	000000	000000	000000	000000	000000	000000	000000

2.2

051	134557	050254	003004	040146	002020	027660	060147	003004
	040100	002020	027660	060255	003004	040150	002020	027660
	060151	003004	040256	002020	027660	060146	070167	060144
	070166	060146	003004	040147	070170	002400	070262	064524
	006002	034162	114576	060174	070166	060150	003004	040151
	002003	027650	070170	060150	070167	064524	006002	034162
	114576	002400	070245	170557	070260	067724	102100	102705
	124152	034251	114545	000002	000001	007725	177746	007670
	124551	002400	070261	060106	002020	027677	033743	070106
	002400	067744	114543	000141	063742	070471	002400	070245
	006400	060262	074262	002021	027720	002400	070471	007400
	124544	060112	050111	027714	124537	000126	044614	046105
	043501	045040	050122	047507	051101	046440	051125	047040
	046111	046511	052123	045117	100000	177765	000000	000000

\$EX10

2.3

BASE PAGE LINKAGE FOR \$EX10

007567	000000	000000	000000	000000	000000	000000	000000	000000
000000	000000	000000	000000	000000	000000	000000	000000	000000
000000	000000	000000	000000	000000	000000	000000	000000	000000
000000	000000	000000	000000	000000	000000	000000	000000	000000
000000	000000	000000	000000	000000	000000	000000	000000	000000
000000	000000	000000	000000	000000	000000	000000	000000	000000
000000	000000	000000	000000	000000	000000	000000	000000	000000
000000	000000	000000	000000	000000	000000	000000	000000	000000
000000	000000	000000	000000	000000	000000	000000	000000	000000
000000	000000	000000	000000	000000	000000	000000	000000	000000
000000	000000	000000	000000	000000	000000	000000	000000	000000
000000	000000	000000	000000	000000	000000	000000	000000	000000
000000	000000	000000	000000	000000	000000	000000	000000	000000
000000	000000	000000	000000	000000	000000	000000	000000	000000
000000	000000	000000	000000	000000	000000	000000	000000	000000
000000	000000	000000	000000	000000	000000	000000	000000	000000
000000	000000	000000	000000	000000	000000	000000	000000	000000
000000	000000	000000	000000	000000	000000	000000	000000	000000

2.4

053	134557	060116	003004	070511	060254	102605	060115	073726
	063751	073727	063754	073730	017671	060467	053747	027634
	002400	067757	114543	000270	060160	070370	060115	017676
	070371	070372	063747	070467	060115	073726	063751	073727
	063755	073730	063731	064051	114536	060200	002002	027641
	060370	027643	060370	070157	070160	067756	060103	002003
	077655	034261	114545	000002	000001	007732	177746	007660
	124551	002400	070245	170557	070260	070261	063750	070471
	002400	124544	000000	063731	006404	114536	127671	000000
	073726	001727	043753	073725	063726	043752	073726	063751
	073727	060052	073730	017671	037725	027703	002400	070270
	067760	060525	003004	044000	060525	127676	000000	000000
	000000	000000	007726	044516	050125	052040	035104	040524
	042454	054130	054130	054130	054130	054130	026110	026115
	051502	042101	000270	000400	177470	000200	000201	177502

\$EX12

DRS

000000	000000	000000	000000	000000	000000	000000	000000
000000	000000	000000	000000	000000	000000	000000	000000
000000	000000	000000	000000	000000	000000	000000	000000
000000	000000	000000	000000	000000	000000	000000	000000
000000	000000	000000	000000	000000	000000	000000	000000
000000	000000	000000	000000	000000	000000	000000	000000
000000	000000	000000	000000	000000	000000	000000	000000
000000	000000	000000	000000	000000	000000	000000	000000
000000	000000	000000	000000	000000	000000	000000	000000
000000	000000	000000	000000	000000	000000	000000	000000

2.9
058

007567	010131	010135	010138	010100	010064	010060	010033
010052	010054	010044	010043	007724	007774	007723	007722
007623	007731	000000	000000	000000	000000	000000	000000
000000	000000	000000	000000	000000	000000	000000	000000
000000	000000	000000	000000	000000	000000	000000	000000
000000	000000	000000	000000	000000	000000	000000	000000
000000	000000	000000	000000	000000	000000	000000	000000
000000	000000	000000	000000	000000	000000	000000	000000
000000	000000	000000	000000	000000	000000	000000	000000
000000	000000	000000	000000	000000	000000	000000	000000
000000	000000	000000	000000	000000	000000	000000	000000
000000	000000	000000	000000	000000	000000	000000	000000
000000	000000	000000	000000	000000	000000	000000	000000
000000	000000	000000	000000	000000	000000	000000	000000
000000	000000	000000	000000	000000	000000	000000	000000
000000	000000	000000	000000	000000	000000	000000	000000
000000	000000	000000	000000	000000	000000	000000	000000
000000	000000	000000	000000	000000	000000	000000	000000
000000	000000	000000	000000	000000	000000	000000	000000
000000	000000	000000	000000	000000	000000	000000	000000
000000	000000	000000	000000	000000	000000	000000	000000

BASE PAGE
LINKAGES
FOR \$EX13

2.10
050

064123	004066	077745	060473	073751	002400	073753	073754
017725	017725	001727	073752	017725	033752	073752	017725
053756	002001	027632	017725	010070	073753	017725	053755
027632	053756	124734	010070	073754	063753	001723	043753
043753	043754	073753	063752	053757	027766	053760	124735
063753	002002	027650	002004	073747	064122	007004	077750
027653	073747	003400	073750	063747	003004	040122	002020
124734	063747	114733	073752	063747	040052	040121	160000
114733	073765	034261	114545	000002	000001	007761	177766
007716	060520	003000	040254	002021	124554	060517	103101
000036	102101	060515	064516	102100	102705	124520	002400
070261	114555	037747	037750	027653	124736	000000	067745
004065	160001	002041	001727	010074	005600	006004	077745
127725	000000	070001	001700	040001	127740	000000	000000
000000	000000	000000	000000	000000	000000	000040	000054
052520	042116	046125	000000	020105	050524	000000	063753

\$EX14

2.11
060

114737	040052	017740	040117	040056	073746	160000	001222
010056	050054	002001	026007	160740	012104	170740	026136
060120	003004	170741	002404	170742	064117	060001	044066
174743	040056	160000	001222	010056	050054	026033	160743
134742	134741	026015	026136	160742	114733	072056	034261
114545	000002	000001	010052	177761	010046	124744	002400
070261	114555	026026	042105	053111	041505	020043	054130
020104	047527	047040	160745	016110	150121	026123	040052
114746	040117	040056	170743	160000	012106	052107	026123
160740	012104	032105	170740	026136	037777	040000	037400
014400	000000	002003	026123	002020	026123	064120	007000
144745	006021	026123	126110	034261	114545	000002	000001
010141	177745	010133	124744	002400	070261	114555	002400
070245	124747	044516	050125	052040	042522	051117	051040
000000	064041	016157	126147	000000	064043	016157	126153
000000	076210	066216	076212	076213	076214	066211	076215

ASCII
1

2,12

ASCII

061	016217	146215	176215	002003	026203	016217	005727	146215
	176215	036215	002002	026167	066214	062212	072214	075212
	066211	126157	010212	000000	000000	000000	000000	030000
	000000	006400	076237	070001	042240	036237	002021	026222
	006020	026223	066240	007004	044000	062237	044052	126217
	000000	000000	000000	000000	000000	000000	000000	000000
	000000	000000	000000	000000	000000	000000	000000	000000
	000000	000000	000000	000000	000000	000000	000000	000000
	000000	000000	000000	000000	000000	000000	000000	000000
	000000	000000	000000	000000	000000	000000	000000	000000
	000000	000000	000000	000000	000000	000000	000000	000000
	000000	000000	000000	000000	000000	000000	000000	000000
	000000	000000	000000	000000	000000	000000	000000	000000
	000000	000000	000000	000000	000000	000000	000000	000000
	000000	000000	000000	000000	000000	000000	000000	000000
	000000	000000	000000	000000	000000	000000	000000	000000
	000000	000000	000000	000000	000000	000000	000000	000000
	000000	000000	000000	000000	000000	000000	000000	000000
	000000	000000	000000	000000	000000	000000	000000	000000

2,13

BASE PAGE LINKAGES FOR \$EX14

062	007567	010147	010123	010062	010136	010110	107746	007750
	047747	007746	007700	007753	007740	107751	010153	000000
	000000	000000	000000	000000	000000	000000	000000	000000
	000000	000000	000000	000000	000000	000000	000000	000000
	000000	000000	000000	000000	000000	000000	000000	000000
	000000	000000	000000	000000	000000	000000	000000	000000
	000000	000000	000000	000000	000000	000000	000000	000000
	000000	000000	000000	000000	000000	000000	000000	000000
	000000	000000	000000	000000	000000	000000	000000	000000
	000000	000000	000000	000000	000000	000000	000000	000000
	000000	000000	000000	000000	000000	000000	000000	000000
	000000	000000	000000	000000	000000	000000	000000	000000
	000000	000000	000000	000000	000000	000000	000000	000000
	000000	000000	000000	000000	000000	000000	000000	000000
	000000	000000	000000	000000	000000	000000	000000	000000
	000000	000000	000000	000000	000000	000000	000000	000000
	000000	000000	000000	000000	000000	000000	000000	000000

2,14

\$EX15

063	174734	060115	170735	160736	170737	160740	170741	160735
	114575	160742	006404	114536	160734	002020	002400	164743
	002002	164744	174745	006004	160746	002002	027622	164001
	006003	027644	027624	050052	027626	040254	027627	060254
	110747	170750	134745	160746	050052	027637	040254	027640
	060153	170751	114752	017744	002001	134745	134745	160746
	002021	027710	060255	110747	170750	060151	170751	114752
	060047	170753	063776	170754	160750	114733	160001	010074
	130755	170001	114756	160757	114733	114756	160757	001265
	160000	114733	114756	134750	134753	027672	017772	002021
	027657	134745	160746	002021	027723	060153	110747	170750
	060147	170751	114752	017744	002400	070245	070113	070471
	164760	114543	000141	002400	064530	006002	124542	060262
	074260	002021	124537	007400	124544	000000	060043	170753
	063776	170754	160750	114733	160001	010074	130755	170001
	114756	160757	114733	114756	134750	134753	027760	017772

2,15

064	002021	027745	127744	000000	114545	000002	000006	000333
	177670	010002	124551	062047	003004	042052	124761	000000
	162037	172051	036051	160001	172051	036051	006004	160001
	172051	036051	006004	160001	172051	036051	126006	000000
	114545	000000	001106	177777	000000	010036	124551	126026
	020040	020000	000000	000000	000000	000000	010042	000000
	000000	000000	000000	000000	177765	000200	000270	000405
	000401	177770	000000	064001	016071	126061	000000	064043

ASCII

DRS

ASCII

016071	125065	000000	076152	066130	076124	076125	076126
066123	076127	016131	146127	176127	002003	026115	016131
005727	146127	176127	036127	002002	026101	066126	062124
072126	076124	066123	126071	010124	000000	000000	000000
000000	030000	000000	006400	076151	070001	042152	036151
002021	026134	006020	026135	066152	007004	044000	062151
040052	126131	000000	000000	000000	000000	000000	000000
000000	000000	000000	000000	000000	000000	000000	000000



2,16

007567	010065	010041	010042	010055	010043	010054	010044
010045	010056	010057	010046	110046	010060	010047	010052
010026	010050	010051	010040	010006	110047	010053	107772
010061	000000	000000	000000	000000	000000	000000	000000

BASE PAGE LINKAGES FOR \$EX15

2,17

000000	077721	063710	073716	060046	073717	060123	000066
073714	060472	001200	003004	073715	017672	017672	017672
017672	002400	173716	017672	002002	027623	037716	037717
002001	027645	173716	027615	053711	027642	053713	027612
010074	043712	073720	163716	070001	001723	040001	040001
043720	173716	027612	037716	037717	027610	060470	073716
006400	074470	074471	074245	007400	002003	124544	003000
040254	002021	124537	063721	002002	114552	002400	067710
102100	102705	127716	000000	063715	002003	127672	067714
004065	160001	002041	001727	010074	037714	037715	127672
127672	000126	000054	177721	000040	000000	000000	000000

\$EX16

2,18

007567	000000	000000	000000	000000	000000	000000	000000
000000	000000	000000	000000	000000	000000	000000	000000
000000	000000	000000	000000	000000	000000	000000	000000
000000	000000	000000	000000	000000	000000	000000	000000
000000	000000	000000	000000	000000	000000	000000	000000
000000	000000	000000	000000	000000	000000	000000	000000
000000	000000	000000	000000	000000	000000	000000	000000
000000	000000	000000	000000	000000	000000	000000	000000
000000	000000	000000	000000	000000	000000	000000	000000
000000	000000	000000	000000	000000	000000	000000	000000
000000	000000	000000	000000	000000	000000	000000	000000
000000	000000	000000	000000	000000	000000	000000	000000
000000	000000	000000	000000	000000	000000	000000	000000
000000	000000	000000	000000	000000	000000	000000	000000
000000	000000	000000	000000	000000	000000	000000	000000

BASE PAGE LINK FOR \$EX16

2.19

060200	170733	064161	002400	170734	170735	054155	160733
070204	160736	006404	114720	160737	114721	002001	027705
160740	160227	010075	150741	006400	074270	160742	050273
060274	150743	060275	150744	027742	160745	070271	060176
070272	060227	164746	114724	060470	170747	114725	070327
060209	140750	064270	006002	060370	070370	070157	064161
054155	070160	160736	064270	006003	160751	074470	064055
114720	060161	050175	006405	124752	060155	070161	060115
070200	160736	114720	060227	164753	114724	160736	064055
114720	060175	070161	160733	070200	124752	060271	170754
164755	150745	164756	150757	164760	154755	160761	174762
160763	164764	114722	160765	164766	114722	114545	000001
000401	010106	177776	007734	124551	160767	150770	027007
150771	124752	027722	006003	027624	160733	170772	070200
001727	170773	170735	160736	006404	114720	060370	170774
060511	002004	170775	134772	134734	160772	070200	160736

\$EX19

2.20

060	006404	114720	160734	070200	160736	064055	114720	160735
140773	072035	036036	124775	002400	070200	062046	006404	
114720	062030	003004	042033	070370	002400	070273	072030	
124777	062105	070470	062035	006400	074245	102100	102705	
124225	000000	000000	000000	000000	000000	000000	000000	
000273	000427	020040	025000	000400	177764	177760	000200	
000201	037477	037440	054505	047117	046102	052123	041040	
042117	051440	051531	051524	042515	010073	013066	000000	
000000	045101	041105	046040	000000	000000	000000	010077	
047513	020124	047440	050125	051107	042477	000000	000000	
000000	000000	000000	000000	000000	000000	000000	000000	
000000	000000	000000	000000	000000	000000	000000	000000	
000000	030000	000000	000000	000000	000000	000000	000000	
000000	000000	000000	000000	000000	000000	000000	000000	
000000	000000	000000	000000	000000	000000	000000	000000	
000000	000000	000000	000000	000000	000000	000000	000000	
000000	000000	000000	000000	000000	000000	000000	000000	

2.21

070	007567	010030	010032	010035	010046	010064	010054	010042
010061	010062	010063	010067	010037	010105	010043	010047	
010020	010040	010066	010051	010060	010055	010056	010050	
010067	010065	010045	010076	010044	010106	010052	010053	
010031	010034	010033	010036	007762	007607	000000	000000	
000000	000000	000000	000000	000000	000000	000000	000000	
000000	000000	000000	000000	000000	000000	000000	000000	
000000	000000	000000	000000	000000	000000	000000	000000	
000000	000000	000000	000000	000000	000000	000000	000000	
000000	000000	000000	000000	000000	000000	000000	000000	
000000	000000	000000	000000	000000	000000	000000	000000	
000000	000000	000000	000000	000000	000000	000000	000000	
000000	000000	000000	000000	000000	000000	000000	000000	
000000	000000	000000	000000	000000	000000	000000	000000	
000000	000000	000000	000000	000000	000000	000000	000000	
000000	000000	000000	000000	000000	000000	000000	000000	
000000	000000	000000	000000	000000	000000	000000	000000	
000000	000000	000000	000000	000000	000000	000000	000000	
000000	000000	000000	000000	000000	000000	000000	000000	
000000	000000	000000	000000	000000	000000	000000	000000	

BASE PAGE LINKAGES FOR \$EX19

2.22

071	060127	073775	001727	114733	170734	006004	160001	010074
130735	170736	060126	070161	114733	130735	170737	060130	
114733	170740	160741	164742	017737	160743	164744	017737	
160745	170746	160747	067777	017737	102011	002400	070200	
006404	017755	160750	050273	060274	150751	060275	150752	
002001	027645	050370	070200	006404	017755	064161	060370	
070157	054155	070160	060154	010074	064372	054000	027733	
005727	077774	044075	074372	034371	064055	017755	064511	
077776	067767	070526	067775	006404	017755	000000	000000	

\$EX20

DRS

\$EX20

017755	063775	073166	063773	070167	002404	073170	067770
074526	063772	164753	034162	114536	037774	037775	037776
027670	160754	170746	160747	067777	017737	102077	006400
074245	074526	074525	124550	160755	164756	017737	027726
000000	073746	077747	034261	114545	000002	000001	000000
000000	017752	124551	002403	070261	127737	000000	070166
063771	073167	160757	070170	063772	034162	114536	127755

2.23

0770	007766	007714	000270	000166	007774	000000	000000
177732	177750	177756	177764	000200	010403	036400	047040
043106	051531	051524	042515	010014	050101	051111	052131
020105	051122	047522	010023	051503	020040	026040	020124
051113	020040	020040	026040	020123	041524	051075	000000
010040	052125	051116	020117	020040	020104	044523	041440
050122	047524	042503	052040	047526	042522	051111	042105
020123	053511	052103	044040	010064	051520	040522	042440
052122	045440	047526	042522	043114	047527	000000	064041
016105	126075	000000	064043	016105	126101	000000	076166
066144	076140	076141	076142	066137	076143	016145	146143
176143	002043	026131	016145	005727	146143	176143	036143
002002	026115	066142	062140	072142	076140	066137	126105
010140	000000	000000	000000	000000	030060	000000	006400
076165	070001	042166	036165	002021	026150	006020	026151
056156	007004	044000	062165	040052	126145	000000	000000

ASCII

3.0

077	007567	010075	010031	010005	010030	010024	010036	010013
010002	010022	010000	010006	010043	010037	010010	010011	000000
010012	010004	010007	010003	010001	010003	010101	000000	000000
000000	000000	000000	000000	000000	000000	000000	000000	000000
000000	000000	000000	000000	000000	000000	000000	000000	000000
000000	000000	000000	000000	000000	000000	000000	000000	000000
000000	000000	000000	000000	000000	000000	000000	000000	000000
000000	000000	000000	000000	000000	000000	000000	000000	000000
000000	000000	000000	000000	000000	000000	000000	000000	000000
000000	000000	000000	000000	000000	000000	000000	000000	000000
000000	000000	000000	000000	000000	000000	000000	000000	000000
000000	000000	000000	000000	000000	000000	000000	000000	000000
000000	000000	000000	000000	000000	000000	000000	000000	000000
000000	000000	000000	000000	000000	000000	000000	000000	000000
000000	000000	000000	000000	000000	000000	000000	000000	000000
000000	000000	000000	000000	000000	000000	000000	000000	000000
000000	000000	000000	000000	000000	000000	000000	000000	000000

BASE PAGE LINKAGES FOR \$EX20

3.1

074	000000	016530	160213	010056	050054	026267	006404	050055
026265	160213	001727	001222	010074	050062	002001	026264	001200
160206	032542	170206	006004	060001	126241	160214	001200	003400
170216	160215	002020	026277	001000	003004	002003	003400	102700
170217	062547	170220	160213	012541	032545	170213	102700	001727
002400	126241	000000	016530	160213	001200	072550	001727	134220
072551	000266	066550	102500	004010	042002	026340	134220	002040
026425	160206	012542	002002	026425	006400	026516	002040	026464
026355	010073	050073	026430	052553	026425	050065	026464	066551
046023	026425	050054	026451	026376	006011	026376	066551	060001
036011	026376	070001	001000	140217	002021	026375	060001	134216
170215	001000	003004	170217	060001	164216	004065	134216	032552
002041	001727	072552	060074	002040	001727	110001	032552	002020
170001	160213	012541	170213	134217	026425	062551	002020	160214
026503	160213	032546	170213	102700	036313	126313	160214	002003
001200	170215	160215	002020	026440	001000	003004	002003	003400

DVR01

3.2

075	003400	170217	062547	170220	160213	032546	170213	026425
-----	--------	--------	--------	--------	--------	--------	--------	--------

DRS

DVRØ1

160214	001200	150216	026425	160216	040052	170216	160217
040052	170217	026425	160213	012541	032545	170213	160214
001200	150216	026425	164216	004065	160001	010075	032542
002040	170001	160217	164215	006020	026514	005000	044000
004031	006004	026516	007004	044000	160206	010075	006003
032542	170206	002400	006003	060055	106700	126313	000000
032554	072324	042543	072310	072425	032544	072526	126530
037777	000000	001200	004000	100000	040000	177742	000000
000000	000000	000015	102500	000000	000000	000000	000000
000000	000000	000000	000000	000000	000000	000000	000000
000000	000000	000000	000000	000000	000000	000000	000000
000000	000000	000000	000000	000000	000000	000000	000000
000000	000000	000000	000000	000000	000000	000000	000000
000000	000000	000000	000000	000000	000000	000000	000000
000000	000000	000000	000000	000000	000000	000000	000000
000000	000000	000000	000000	000000	000000	000000	000000
000000	000000	000000	000000	000000	000000	000000	000000



3.3

BASE PAGE LINKS FOR DVRØ1

076	010241	010315	000000	000000	000000	000000	000000
000000	000000	000000	000000	000000	000000	000000	000000
000000	000000	000000	000000	000000	000000	000000	000000
000000	000000	000000	000000	000000	000000	000000	000000
000000	000000	000000	000000	000000	000000	000000	000000
000000	000000	000000	000000	000000	000000	000000	000000
000000	000000	000000	000000	000000	000000	000000	000000
000000	000000	000000	000000	000000	000000	000000	000000
000000	000000	000000	000000	000000	000000	000000	000000
000000	000000	000000	000000	000000	000000	000000	000000
000000	000000	000000	000000	000000	000000	000000	000000
000000	000000	000000	000000	000000	000000	000000	000000
000000	000000	000000	000000	000000	000000	000000	000000
000000	000000	000000	000000	000000	000000	000000	000000
000000	000000	000000	000000	000000	000000	000000	000000

3.4

077	000000	016420	160213	010056	050054	126241	050055	026300
160213	001727	001222	010073	050063	026263	050064	026267	
060055	126241	062442	170216	002400	026276	160214	002021	
003004	002203	003400	170216	060065	170217	026313	160214	
001200	170216	160215	002020	026310	001000	003004	170217	
002400	170220	062441	072320	026322	002400	126241	000000	
016420	160213	070001	001727	001200	072440	002400	150216	
026402	004010	026360	150217	026364	164216	134216	004065	
160001	062041	001727	010074	066440	134217	026354	006020	
020354	052436	026402	102600	102700	036320	126320	160217	
134216	003000	026354	062440	002020	026402	164220	062435	
056435	060065	170220	056435	026377	026354	006400	174216	
026354	102500	070001	160206	010075	030001	170206	002400	
006002	060055	164215	006020	007004	106700	126320	000000	
032437	072402	040067	072354	042433	072355	032434	072416	
126420	000000	001100	004000	000015	000137	102500	000000	

DVRØ2

3.5

078	010315	177610	000000	000000	000000	000000	000000
000000	000000	000000	000000	000000	000000	000000	000000
000000	000000	000000	000000	000000	000000	000000	000000
000000	000000	000000	000000	000000	000000	000000	000000
000000	000000	000000	000000	000000	000000	000000	000000
000000	000000	000000	000000	000000	000000	000000	000000
000000	000000	000000	000000	000000	000000	000000	000000
000000	000000	000000	000000	000000	000000	000000	000000
000000	000000	000000	000000	000000	000000	000000	000000
000000	000000	000000	000000	000000	000000	000000	000000
000000	000000	000000	000000	000000	000000	000000	000000
000000	000000	000000	000000	000000	000000	000000	000000
000000	000000	000000	000000	000000	000000	000000	000000
000000	000000	000000	000000	000000	000000	000000	000000

DRS

000000	000000	000000	000000	000000	000000	000000	000000
000000	000000	000000	000000	000000	000000	000000	000000
000000	000000	000000	000000	000000	000000	000000	000000
000000	000000	000000	000000	000000	000000	000000	000000
000000	000000	000000	000000	000000	000000	000000	000000

3.6 BASE PAGE LEVELS FOR DVR2

079	010241	013329	000000	000000	000000	000000	000000	000000
	000000	000000	000000	000000	000000	000000	000000	000000
	000000	000000	000000	000000	000000	000000	000000	000000
	000000	000000	000000	000000	000000	000000	000000	000000
	000000	000000	000000	000000	000000	000000	000000	000000
	000000	000000	000000	000000	000000	000000	000000	000000
	000000	000000	000000	000000	000000	000000	000000	000000
	000000	000000	000000	000000	000000	000000	000000	000000
	000000	000000	000000	000000	000000	000000	000000	000000
	000000	000000	000000	000000	000000	000000	000000	000000
	000000	000000	000000	000000	000000	000000	000000	000000
	000000	000000	000000	000000	000000	000000	000000	000000
	000000	000000	000000	000000	000000	000000	000000	000000
	000000	000000	000000	000000	000000	000000	000000	000000
	000000	000000	000000	000000	000000	000000	000000	000000
	000000	000000	000000	000000	000000	000000	000000	000000
	000000	000000	000000	000000	000000	000000	000000	000000
	000000	000000	000000	000000	000000	000000	000000	000000
	000000	000000	000000	000000	000000	000000	000000	000000
	000000	000000	000000	000000	000000	000000	000000	000000
	000000	000000	000000	000000	000000	000000	000000	000000

37	000000	164207	005600	064257	005623	174207	016700	073001
	002001	015536	160213	010056	050056	026401	004033	026252
	000031	026346	005310	026346	016524	016550	076550	007007
	026376	044045	160214	006121	026330	072536	060045	072524
	072612	060257	067037	050062	067046	076521	160213	001727
	001226	002541	063055	170001	006004	036612	026314	066521
	162536	170001	036536	006004	036550	026321	062521	016633
	066261	063030	016657	010266	016557	067056	062345	016657
	010336	064064	063034	016657	010342	150215	026372	016612
	060050	170217	016550	160214	016633	067057	063035	016657
	010353	016557	134217	002001	026567	067056	062361	016657
	010366	160213	010067	002002	026440	060057	126241	016536
	160213	013050	053061	026376	004033	026400	053062	026422
	053063	026440	053064	026445	053065	026452	050067	026476
	026531	016625	067056	063031	016657	010423	002400	170207
	006401	006404	063001	002020	026376	002400	127001	016524

DVR2



38	001	064056	063036	016657	010441	016625	067066	063031	016657
		010446	016521	010067	002003	026462	064056	062475	016657
		010456	067067	107627	016521	001323	001310	026472	102727
		026427	067063	062475	016657	010462	005310	026546	016612
		064064	062510	016657	010501	067070	063033	016657	010505
		016521	013071	002003	026432	067056	063032	016657	010515
		000000	102527	126521	000000	016521	013072	002103	126524
		067001	060055	006021	127001	126241	000000	005727	006020
		026546	067063	062536	016657	110536	060056	126241	000000
		164215	006321	007005	005100	076524	126550	000000	016521
		013071	002002	126557	160213	002011	026573	016521	001727
		002020	026606	102502	002002	033073	003004	016550	044000
		007004	160215	002020	005000	026436	164215	006020	007004
		026436	000000	016521	013072	002303	126612	160207	001623
		170207	002340	026531	126612	000000	016521	010067	002002
		026427	126625	000000	036635	177777	106702	001225	102602

39	002	062557	033074	102606	102702	062524	142602	126633	003400
		072635	162657	001275	160000	067063	002001	000000	170216

147627	016521	001323	001310	026650	002400	052635	103726
147272	036635	103706	063001	002007	126241	124000	000000
072557	064000	062706	016775	072706	106726	002004	072711
104727	062670	016775	072670	006004	062463	016775	072463
072661	062470	016775	072470	072671	062522	016775	072522
064257	062643	016775	072643	073013	040047	072640	072646
062673	016775	072673	062747	016775	072747	106706	040047
044047	072636	062573	016775	072573	062644	016775	072644
016521	010074	070001	160206	010075	030001	170206	016521
070001	003400	072635	126700	000000	010077	030001	126775
000000	164207	005205	006002	000001	027022	074257	040052
016700	002400	102606	160216	004050	002405	124000	006400
127001	070001	063026	016775	073026	106700	026674	010335
010427	010500	010511	010265	010362	010431	011040	020040

3.10
083

020040	020040	020040	020040	020040	011047	020040	020040
020040	020040	020040	020040	020040	000041	000023	017700
000600	000200	000300	000400	000500	000201	000101	000035
000022	030040	140000	060000	000000	000000	000000	000000
000000	000000	000000	000000	000000	000000	000000	000000
000000	000000	000000	000000	000000	000000	000000	000000
000000	000000	000000	000000	000000	000000	000000	000000
000000	000000	000000	000000	000000	000000	000000	000000
000000	000000	000000	000000	000000	000000	000000	000000
000000	000000	000000	000000	000000	000000	000000	000000
000000	000000	000000	000000	000000	000000	000000	000000
000000	000000	000000	000000	000000	000000	000000	000000
000000	000000	000000	000000	000000	000000	000000	000000
000000	000000	000000	000000	000000	000000	000000	000000
000000	000000	000000	000000	000000	000000	000000	000000
000000	000000	000000	000000	000000	000000	000000	000000
000000	000000	000000	000000	000000	000000	000000	000000

3.11

BASE PAGE LINKS FOR DVR22

010241	011001	000000	000000	000000	000000	000000	000000
000000	000000	000000	000000	000000	000000	000000	000000
000000	000000	000000	000000	000000	000000	000000	000000
000000	000000	000000	000000	000000	000000	000000	000000
000000	000000	000000	000000	000000	000000	000000	000000
000000	000000	000000	000000	000000	000000	000000	000000
000000	000000	000000	000000	000000	000000	000000	000000
000000	000000	000000	000000	000000	000000	000000	000000
000000	000000	000000	000000	000000	000000	000000	000000
000000	000000	000000	000000	000000	000000	000000	000000
000000	000000	000000	000000	000000	000000	000000	000000
000000	000000	000000	000000	000000	000000	000000	000000
000000	000000	000000	000000	000000	000000	000000	000000
000000	000000	000000	000000	000000	000000	000000	000000
000000	000000	000000	000000	000000	000000	000000	000000
000000	000000	000000	000000	000000	000000	000000	000000
000000	000000	000000	000000	000000	000000	000000	000000
000000	000000	000000	000000	000000	000000	000000	000000

3.12

160001	002002	131003	171004	006004	160001	002003	026012
131005	171006	006004	160001	171007	006004	160001	171010
006004	160001	171011	002400	171012	171013	171014	060527
161015	026035	171016	002400	165017	115020	060255	171021
171022	003004	171023	040256	171024	141025	171026	002004
171027	171030	161025	003004	040255	171031	060045	040100
171032	171033	161024	003004	171034	165025	002400	170001
006004	135034	026067	114535	012101	000066	020677	015171
020771	161035	003004	141036	070001	040051	002020	027307
161036	002004	001727	073037	161035	003004	141036	001100
141035	001727	171037	001727	064155	054161	026132	060154

LOADR

13,6

001	004003	000413	014004	000415	004005	000421	004007	000423	EXEC MODULE
	004010	000425	010011	000427	004012	001002	004014	001004	DOUBLET
	014015	001006	014016	001012	010017	001016	004020	001021	TABLE
	010023	001023	010024	001026	000000	000000	000000	000000	CRS 4
	000000	000000	000000	000000	000000	000000	000000	000000	
	000000	000000	000000	000000	000000	000000	000000	000000	
	000000	000000	000000	000000	000000	000000	000000	000000	
	037567	037135	037405	016000	036514	036515	001633	007777	
	006000	002266	004134	004000	004150	005010	005035	005071	
	005152	003123	003151	002135	006000	000471	000513	000534	
	010132	010144	010072	010030	010000	011135	011210	000765	
	011005	011114	001461	010021	005177	003136	007660	010755	
	015400	015600	015732	006004	005160	005324	003525	005334	
	001160	001163	001177	001211	001223	012246	002151	000522	
	000523	000673	007726	012000	000207	001300	015747	015750	

13,7

002	010400	020000	167137	040523	041511	044440	000072	000000	RELOCATABLE
	000000	000000	000143	000000	000000	000000	000000	000000	LIBRARY
	000000	005400	040002	170452	041516	042105	041400	000000	
	041516	047503	052000	000004	036000	060135	140462	000000	
	001320	000000	004041	016000	000010	126000	000000	000000	
	013212	064043	016000	000010	126000	000004	000000	076000	
	000071	133332	066000	000047	076000	000043	076000	000044	
	076000	000045	066000	000042	133320	076000	000046	016000	
	000050	146000	000046	176000	000046	002003	132132	026000	
	000034	016000	000050	005727	146000	000046	176000	000046	
	121320	036000	000046	002002	026000	000020	056000	000045	
	010400	050106	121765	000035	133332	062000	000043	072000	
	000045	076000	000043	066000	000042	126000	000010	020000	
	000043	021000	060122	052445	000046	000012	000000	030000	
	000000	006400	076000	000070	013212	070001	042000	000071	
	036000	000070	002021	026000	000053	013200	006020	026000	

13,8

003	000054	066000	000071	007004	044000	121200	062000	000070	
	040052	126000	000050	003000	060101	060172	000071	000000	
	000000	002000	120000	000000	000000	000000	000000	000000	
	000000	000000	000000	000000	000000	000000	000000	000000	FOR
	000000	000000	000000	000000	000000	000000	000000	000000	TOTAL
	000000	000000	000000	000000	000000	000000	000000	000000	OF
	000000	000000	000000	000000	000000	000000	000000	000000	147
	000000	000000	000000	000000	000000	000000	000000	000000	SECTORS
	000000	000000	000000	000000	000000	000000	000000	000000	
	000000	000000	000000	000000	000000	000000	000000	000000	
	000000	000000	000000	000000	000000	000000	000000	000000	
	000000	000000	000000	000000	000000	000000	000000	000000	
	000000	000000	000000	000000	000000	000000	000000	000000	
	000000	000000	000000	000000	000000	000000	000000	000000	
	000000	000000	000000	000000	000000	000000	000000	000000	
	000000	000000	000000	000000	000000	000000	000000	000000	
	000000	000000	000000	000000	000000	000000	000000	000000	
	000000	000000	000000	000000	000000	000000	000000	000000	
	000000	000000	000000	000000	000000	000000	000000	000000	

13,9

004	010400	020000	005144	042125	046522	054040	000064	000000	
	000000	000000	000143	000000	000000	000000	000000	000000	
	000000	005400	040002	142464	022114	044502	051000	000000	
	022114	044502	054000	000026	035400	060136	033267	000000	
	013320	000000	072000	000056	162000	000000	036000	000000	
	002002	133200	026000	000010	036000	000061	026000	000024	
	002004	002004	121332	076000	000057	005500	076000	000060	
	066000	000000	046000	000062	001212	164001	174000	066000	

CRS,

19,11

001	124003	004150	114532	114532	114532	114532	114532	114532	114532	JSB *GIC
	114532	114532	114532	114532	114532	114532	114532	114532	114532	
	114532	114532	114532	114532	114532	114532	114532	114532	114532	CONSTANTS
	114532	114532	114532	114532	114532	114532	114532	114532	114532	
	177767	177770	177771	177772	177773	177774	177775	177776	177776	
	177777	000000	000001	000002	000003	000004	000005	000006	000006	
	000007	000010	000011	000012	000021	000100	000017	000037	000037	
	000077	000177	000377	177400	003777	177700	037633	000000	000000	
	000000	000012	000000	000000	000000	000000	000000	000001	000001	
	000001	000000	000003	013000	000030	007361	000005	007506	007506	
	000007	037634	000000	000000	000000	000000	000000	000000	000000	
	000000	000000	000000	000000	000000	000000	000000	000000	000000	
	000000	000000	000000	000000	000000	000000	000000	000000	000000	
	000000	000000	060307	000001	000001	013400	013400	000001	000001	
	000000	000377	000377	000000	000000	000000	000000	000000	000000	
	000000	000000	000003	000001	021450	000000	013000	007515	007515	

19,12

002	000016	000000	000000	000000	000000	000000	000000	000000	000000	BASE PAGE COMMUNICATION AREA
	000000	000000	000000	000000	000000	000000	000000	000000	000000	
	000000	000000	000000	000000	000000	000000	000000	000000	000000	
	000000	000000	000000	000000	000000	000000	000000	000000	000000	
	000000	007533	000016	000000	007567	010241	000732	001000	001000	
	010241	001000	012000	001002	001633	000000	000000	000000	000000	
	000000	002024	010453	000412	000000	000000	000000	000000	000000	
	000000	000000	000000	000000	000000	000000	000000	000000	000000	
	000000	000000	000000	000000	000000	000000	000000	000000	000000	
	000000	000000	000000	000000	000000	000000	000000	000000	000000	
	000000	000000	000000	000000	000000	000000	000000	000000	000000	
	000000	000000	000000	000000	000000	000000	000000	000000	000000	
	000000	000000	000000	000000	000000	000000	000000	000000	000000	
	000000	000000	000000	000000	000000	000000	000000	000000	000000	
	000000	000000	000000	000000	000000	000000	000000	000000	000000	

19,13

003	000000	000000	000000	000000	000000	000000	000000	000000	000000	DISCM ENTRY POINTS LINKAGE
	000000	000000	000000	000000	000000	000000	000000	000000	000000	
	000000	000000	000000	000000	000000	000000	000000	000000	000000	
	000000	000000	000000	000000	000000	000000	000000	000000	000000	
	000000	000000	000000	000000	000000	000000	000000	000000	000000	
	000000	000000	000000	000000	000000	000000	000000	000000	000000	
	000000	000000	000000	000000	000000	000000	000000	000000	000000	
	000000	000000	000000	000000	000000	000000	000000	000000	000000	
	000000	000000	000000	000000	000000	000000	000000	000000	000000	
	000000	000000	000000	000000	000000	000000	000000	000000	000000	
	000000	000000	000000	000000	000000	000000	000000	000000	000000	
	000000	000000	000000	000000	000000	000000	000000	000000	000000	
	000000	000000	000000	000000	000000	000000	000000	000000	000000	
	000000	000000	000000	000000	000000	000000	000000	000000	000000	
	000000	000000	000000	000000	000000	000000	000000	000000	000000	

19,14

004	004303	004314	004376	000000	000000	000000	004446	000000	000000	EXEC MODULES ENTRY LINKS
	000000	000000	000000	004505	000000	000000	000000	000000	000000	
	000000	004671	005264	000000	000000	002322	002222	002637	002637	
	004262	004151	001746	004034	004125	004304	004305	001736	001736	
	001726	001723	004300	004301	004307	004272	004312	004313	004313	
	004310	004311	004274	004150	004126	004127	004135	004124	004124	
	004005	004024	004136	004035	004137	004277	004131	004132	004132	
	004133	004134	004270	004275	004130	004145	004146	004147	004147	

DISCM PAGE BOUNDARY LINKS

003607	002213	003743	103575	003325	002463	003204	003213
003220	003236	003003	005774	006011	006266	006354	006336
006372	106774	006330	006315	006410	006464	006660	006743
000000	000000	000000	000000	000000	000000	000000	000000
000000	000000	000000	000000	000000	000000	000000	000000
000000	000000	000000	000000	000000	000000	000000	000000
000000	000000	000000	000000	000000	000000	000000	000000
000000	000000	000000	000000	000000	000000	000000	000000

LINKS
EXEC MODULES
LINKS

14, 15

005	023776	154025	117770	060413	115184	041036	102074	012670
	025574	053370	126760	004446	101114	130736	070402	161004
	150516	127742	066412	155024	140556	110042	026612	055424
	133050	074626	000162	000344	000710	001620	003440	007100
	016200	034400	071000	162000	152506	133722	076352	003432
	007064	014150	034320	070640	161500	151706	132322	073352
	168724	164356	157442	145612	122132	052772	125764	062456
	145134	120776	050502	121204	051110	122234	053176	126374
	063476	147174	125076	060702	141604	112116	032742	065704
	153610	136126	102762	014452	031124	062250	144520	117746
	046422	115044	040616	101434	011576	023374	046770	115760
	042446	105114	020736	041674	103570	016066	034154	070330
	160660	150246	127222	065152	152324	133356	075442	001612
	003424	007050	016120	034240	070500	161200	151106	130722
	070352	160724	150356	127442	065612	153424	135556	102042
	012612	025424	053050	126120	062746	145714	122336	103216

19, 16

006	002502	175321	012410	165774	052040	124100	056706	135614
	102136	013002	020004	054010	130020	066546	155314	141336
	111402	031512	063224	146450	125026	050162	134344	077416
	005542	013304	026610	055420	133040	074606	000122	000244
	000510	001220	002440	005100	012200	024400	051000	122000
	052506	125214	061136	142274	113276	035302	072604	165410
	161526	151762	132452	073632	167464	165656	162242	153212
	135132	100772	010472	021164	042350	104720	020346	040714
	101630	010166	024354	050730	121660	052246	124514	007736
	137674	106276	023302	046604	115410	041526	103254	015236
	032474	065170	152360	133446	075622	002152	004324	010650
	021520	043240	106500	023706	047614	117430	045566	113354
	035436	073074	166170	163066	154662	140252	107232	025172
	052364	124750	060426	141054	110636	030202	060404	141010
	110526	027762	057744	137710	106326	023362	046744	110710
	042326	104654	020236	040474	101170	011066	022154	170601

REMAINDER
OF
TRACK
19
NOT
USED

19, 17

007	110660	067143	060514	117671	111166	031062	062144	144310
	117326	045362	112744	034416	071034	162070	152666	134262
	077252	005232	012464	025150	052320	124640	060206	140414
	107536	026002	054004	130010	066526	155254	141236	111202
	031112	062224	144450	117626	046162	114344	037416	077034
	004576	011374	022770	045760	113740	036406	075014	000536
	001274	002570	005360	012740	025700	053600	127400	065506
	153214	135136	101002	010512	021224	042450	105120	020746
	041714	103630	016166	034354	070730	161660	152246	133222
	075152	001032	002064	004150	010320	020640	041500	103200
	015106	032214	064430	151060	130646	070222	160444	147616
	126142	063012	146024	122556	054042	130104	066716	155634
	142176	113102	034712	071624	163450	155626	142162	113052
	034632	071464	163150	150026	140562	110052	026632	055464
	133150	075026	000562	001344	002710	005620	013440	027100
	056200	134400	077506	005722	013644	027510	057220	127110

21,23

061	026000	000273	162000	000164	002002	026000	000061	002004
120132	072000	000160	004122	007004	076000	000161	026000	
000064	121320	072000	000160	003400	072000	000161	062000	
000160	003004	001320	040102	002000	026000	000334	062000	
000160	035400	060147	112466	000072	113200	016004	072000	
000173	062000	000160	040052	040121	011210	160000	016004	
072000	000176	034261	016001	000202	000002	000001	000172	
177766	000127	000010	060070	003000	040254	002021	026002	
000000	060517	103101	000036	102101	060515	000000	064516	
102100	102700	124520	002400	011332	070261	016003	036000	
000160	036000	000161	026000	000064	121200	026000	000347	
000000	066000	000156	004065	017000	060123	011144	000141	
040000	160001	002041	001727	010074	005600	013200	006404	
076000	000156	126000	000136	000000	070001	001200	001700	
040001	126000	000151	000000	000000	000000	000000	000000	
000000	000000	035000	050143	112160	000166	000000	000000	

22,0

062	046102	042117	021450	050521	050521	050421	044456	031461
020000	036173	000723	041456	031461	020000	036173	000724	
044456	031062	020000	036164	000000	041456	031062	020000	
036164	000000	046117	040004	051000	036155	000000	163252	C.S.
041120	051000	036146	000000	040523	046502	020000	036137	
000000	037501	051503	047000	036137	000000	037501	051515	
041000	036137	000000	037502	047103	047000	036137	000000	
037502	050113	052400	036137	000000	037503	044117	050000	
033403	000000	000312	000000	177250	046000	020000	020000	
042000	020000	020000	020000	020000	000000	000000	000000	
000000	000000	000000	000000	000000	000001	000001	000003	
000003	000004	000002	000001	000005	000000	000000	050521	
050521	050421	044456	031461	020000	037515	051531	046400	
036137	000000	037522	046125	047000	036137	000000	037501	
043114	043400	036137	000000	037514	051524	046000	036137	SB
000000	037514	052516	044400	036137	000000	037522	051502	

22,1

063	054122	042506	020003	013400	000015	012000	014750	001002	XREF
001036	012000	014071	042517	052061	020011	013415	000001	000001	EOT/
053505	047524	020003	013416	000002	012000	012013	001002		
001003	012000	012013	054122	042506	051010	013420	000020		
042111	051503	046410	014010	000024	042530	042503	051410		
014404	000077	042126	051060	032410	015423	000003	042126		
051063	030410	015426	000005	046111	041122	054410	016003		ETC
000217	042126	051060	031010	021002	000002	042126	051000		
030410	021004	000003	042126	051062	031010	021007	000007		
046117	042122	020010	021016	000061	046117	041120	020010		
022017	000101	040523	046502	046010	023410	000050	040523		
046504	020010	024400	000004	040523	046463	020010	024404		
000004	040523	046464	020010	024410	000006	040523	046465		
020010	024416	000012	043122	052116	020010	025000	000010		
043124	047061	020010	025010	000060	043124	047062	020010		
026010	000055	043124	047063	020010	027005	000052	177777		

22,2

064	043124	047064	020010	027007	000037	040523	046461	020010
030406	000014	040523	046462	020010	030422	000013	051511	
047461	020011	031005	000005	041101	051503	030411	031012	
000011	041117	047524	020011	031023	040025	043124	047110	
020011	031420	000001	042517	043040	020003	031421	000001	
012000	012013	001002	001002	012000	012013	043123	050103	
042403	031422	000001	012000	012013	001002	001002	012000	
012013	051127	044516	042003	031423	000001	012000	012013	

TK55

USER LABEL / SYSTEM BUFFER SECTOR

USER DIRECTORY

LAST DIRECTORY ENTRY IN SECTOR

**END OF
USER DIRECTORY**

**USER
DIRECTORY**

001002	001002	012000	012013	042056	030060	051411	031424
000103	052123	051124	051411	033017	000006	052123	051124
051010	033025	000005	041014	042001	001012	033402	000001
000000	020010	024400	000004	040523	046453	020010	024404
000003	040523	046454	020010	000005	040523	040523	040505
020010	024416	000012	043122	052116	020010	025000	000010
043124	047061	020010	025010	000060	043124	047062	020010
020010	000055	043124	047063	020010	027005	000052	177777

22,3

000257	162000	000057	012120	050052	026000	000050	040204
026000	000001	000103	133210	072000	000263	016000	000237
016000	000155	002001	036000	000257	132120	036000	000257
162000	000257	002021	026000	000121	060255	132132	012000
000271	072000	000260	060151	072000	000263	016000	000237
013320	060047	072000	000261	060000	000207	072000	000262
035000	050136	017074	000074	130012	062000	000260	016012
160001	010074	032000	000051	013312	170001	016000	000217
162000	000260	016012	016000	000217	120112	162000	000260
001265	160000	016012	016000	000217	133320	036000	000260
036000	000261	026000	000103	016000	000203	002021	133212
026000	000070	036000	000257	162000	000257	002021	026000
000134	013212	060153	012000	000271	072000	000260	060147
072000	000263	035000	060143	044350	000132	132000	016000
000237	016000	000155	002400	070245	070113	013000	070471
066000	000264	016007	000141	002400	001000	064530	006002

22,4

026005	060262	074262	010100	002021	026004	007400	026010
000000	013332	060043	072000	000261	062000	000207	072000
000202	062000	000260	100100	016012	160001	016074	032000
000251	170001	133132	016000	000217	162000	000260	016012
016000	000217	036000	000260	035400	060140	044452	000175
133212	036000	000261	026000	000171	016000	000203	002021
026000	000156	121000	126000	000155	000000	016002	000002
000006	000312	000333	177070	000213	026011	062000	000260
013212	003004	012000	000263	100000	000203	000000	062000
000250	132132	172000	000262	036000	000262	160001	172000
000262	036000	000262	001320	006004	160001	172000	000262
036000	000262	006004	012000	160001	172000	000262	014700
060116	153075	000235	132100	036000	000262	126000	000217
000000	016002	000003	000030	001106	177777	000000	000247
026011	120000	126000	000237	020040	020000	000000	011400
060114	102330	000256	020000	000253	000000	000000	000000

22,5

000000	000000	000000	177765	000200	000270	000405	000000
000411	177770	002000	120000	120000	000000	000000	000000
000000	000000	000000	000000	000000	000000	000000	000000
000000	000000	000000	000000	000000	000000	000000	000000
000000	000000	000000	000000	000000	000000	000000	000000
000000	000000	000000	000000	000000	000000	000000	000000
000000	000000	000000	000000	000000	000000	000000	000000
000000	000000	000000	000000	000000	000000	000000	000000
000000	000000	000000	000000	000000	000000	000000	000000
000000	000000	000000	000000	000000	000000	000000	000000
000000	000000	000000	000000	000000	000000	000000	000000
000000	000000	000000	000000	000000	000000	000000	000000
000000	000000	000000	000000	000000	000000	000000	000000
000000	000000	000000	000000	000000	000000	000000	000000
000000	000000	000000	000000	000000	000000	000000	000000
000000	000000	000000	000000	000000	000000	000000	000000
000000	000000	000000	000000	000000	000000	000000	000000
000000	000000	000000	000000	000000	000000	000000	000000
000000	000000	000000	000000	000000	000000	000000	000000
000000	000000	000000	000000	000000	000000	000000	000000
000000	000000	000000	000000	000000	000000	000000	000000
000000	000000	000000	000000	000000	000000	000000	000000
000000	000000	000000	000000	000000	000000	000000	000000

**REST OF
TRACK
22
IS
RESERVED
FOR USER
DIRECTORY
ENTRIES**

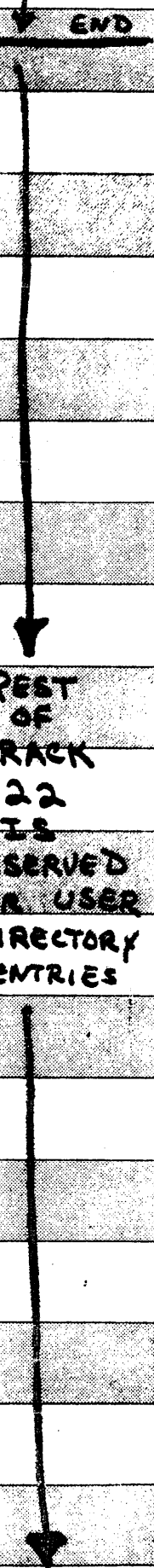

CORE MAP FOR DOSM SYSTEM GENERATION EXAMPLE (16K)

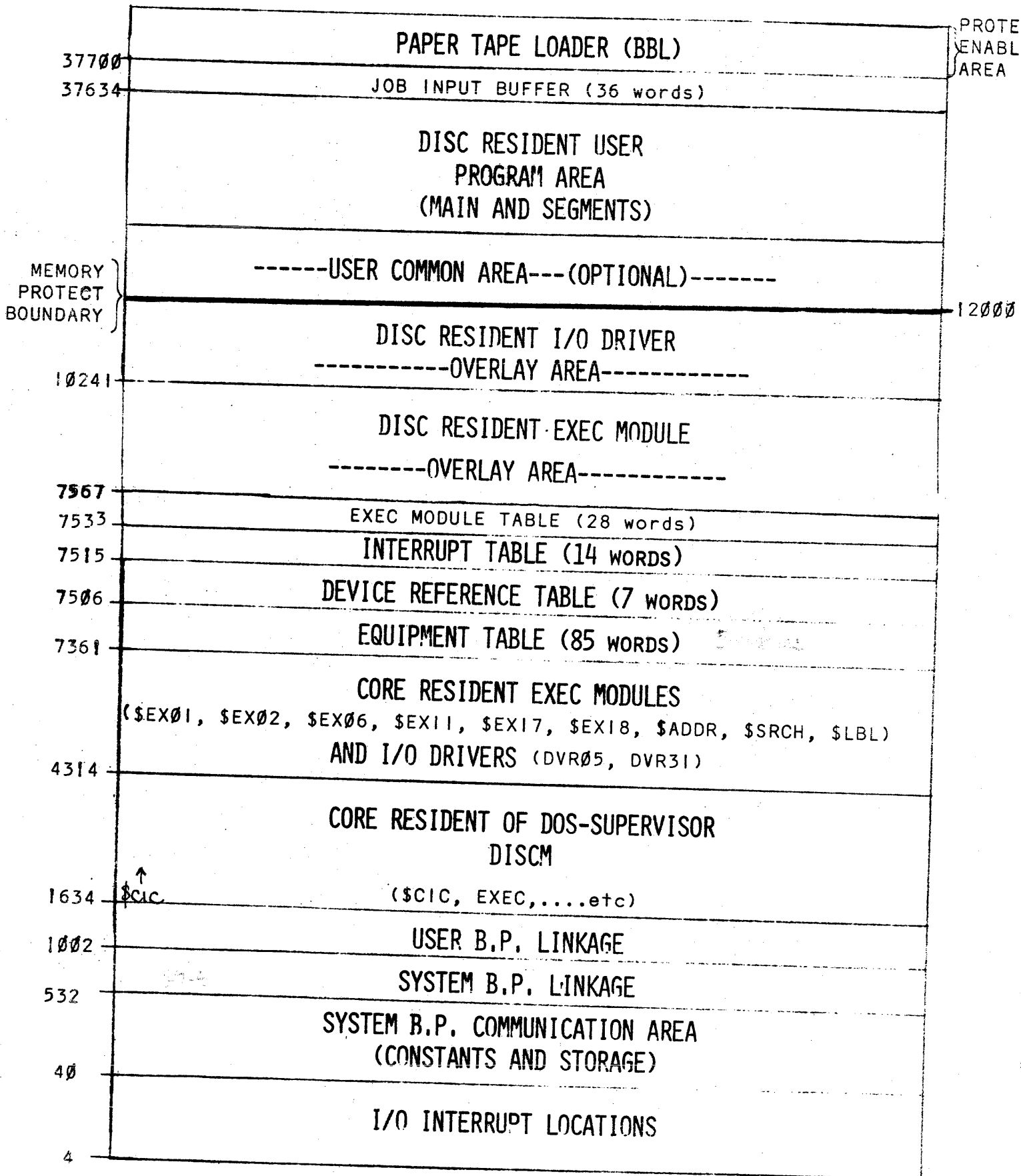

EQUIPMENT TABLE ENTRY FORMAT

- D = 1 IF DMA CHANNEL REQUIRED.
- R = 1 IF DRIVER TYPE IS CORE-RESIDENT.
- UNIT # MAY BE USED FOR SUB-CHANNEL ADDRESSING.
- CHANNEL # I/O SELECT CODE FOR DEVICE (LOWER NUMBER IF MULTIBOARD INTERFACE.)

- AV = 0 - UNIT NOT BUSY AND AVAILABLE
 - = 1 - UNIT DISABLED (DOWN)
 - = 2 - UNIT BUSY
 - = 3 - UNIT WAITING FOR AN AVAILABLE DMA CHANNEL
- (THIS FIELD SET BY SYSTEM)

STATUS - ACTUAL OR SIMULATED UNIT STATUS AT END OF OPERATION.
(DRIVER MUST SET THIS FIELD)

EQUIPMENT TYPE CODE - IDENTIFIES TYPE OF DEVICE AND ASSOCIATED SOFTWARE DRIVER. ASSIGNED EQUIPMENT TYPE CODES IN OCTAL ARE

00-07	PAPER TYPE DEVICES
00	TELEPRINTER
01	PUNCHED TAPE READER
02	HIGH SPEED PUNCH
05	TELETYPE (SYSTEM)

10-17	UNIT RECORD DEVICES
10	RESERVED FOR PLOTTER
12	LINE PRINTER
15	MARK SENSE CARD READER

20-37	MAGNETIC TAPE/MASS STORAGE AND OTHER DEVICES CAPABLE OF BOTH INPUT AND OUTPUT.
22	3030 MAGNETIC TAPE
31	MOVING-HEAD DISC

FOR EQUIPMENT TYPE CODES 1 THROUGH 17, ODD NUMBER INDICATE INPUT DEVICES AND EVEN NUMBER INDICATE OUTPUT DEVICES (EXCEPT 05, WHICH IS BOTH INPUT AND OUTPUT).

WORD	CONTENTS															
1	DRIVER "INITIATION" SECTION ADDRESS															
2	DRIVER "CONTINUATION" SECTION ADDRESS															
3	D	R					UNIT #									CHANNEL #
4	AV		EQUIPMENT TYPE CODE				STATUS									
5	(SAVED FOR DRIVER USE)															
6	(SAVED FOR DRIVER USE)															
7	REQUEST RETURN ADDRESS															
8	REQUEST CODE															
9	CURRENT I/O REQUEST CONTROL WORD															
10	REQUEST BUFFER ADDRESS															
11	REQUEST BUFFER LENGTH															
12	TEMPORARY OR DISC TRACK #															
13	TEMPORARY OR STARTING SECTOR #															
14	TEMPORARY STORAGE FOR DRIVER															
15	UPPER MEMORY ADDRESS OF MAIN DRIVER AREA															
16	UPPER MEMORY ADDRESS OF DRIVER LINKAGE AREA															
17	STARTING TRACK #								STARTING SECTOR #							
BITS	15	14	13	12	11	10	9	8	7	6	5	4	3	2	1	0

0's IF CORE-RESIDENT

AVAILABLE FOR DRIVER TEMPORARY

DEVICE REFERENCE TABLE FORMAT

EACH ENTRY IN THIS TABLE REQUIRES ONLY ONE WORD IN MEMORY. THE VALUE OF EACH ENTRY (DECIMAL NUMBER, 1-63) ASSOCIATES A LOGICAL UNIT NUMBER WITH AN EQUIPMENT TABLE ENTRY FOR THE SYSTEM IN THE FOLLOWING MANNER:

SEQUENCE IN MEMORY TABLE	LOGICAL UNIT #	FUNCTION
1	1	SYSTEM TELEPRINTER
2	2	USER MASS STORAGE
3	3	SYSTEM MASS STORAGE
4	4	STANDARD PUNCH DEVICE
5	5	STANDARD INPUT DEVICE
6	6	STANDARD LIST DEVICE
7-63	7-63	ANY DEVICE

INTERRUPT TABLE FORMAT

EACH ENTRY IN THIS TABLE REQUIRES ONLY ONE WORD IN MEMORY AND IS ASSOCIATED WITH EACH I/O CHANNEL IN THE COMPUTER (STARTING WITH LOCATION 6) WHICH CAN CAUSE AN INTERRUPT. EACH LOCATION IN THIS TABLE HAS AN ENTRY VALUE. MEMORY LOCATIONS ARE ASSOCIATED IN CONSECUTIVE INCREASING ORDER WITH AN I/O CHANNEL. TABLE VALUES ARE ZERO FOR AN I/O CHANNEL NOT REQUIRING INTERRUPT. I/O CHANNELS REQUIRING INTERRUPT CONTAIN THE START ADDRESS OF THE EQUIPMENT TABLE ENTRY OF THE ASSOCIATED DEVICE.

I/O channel
6 ← starting loc →
7
10
11
↓

*if contents = 0 no interrupt occurs
start addr. of eqpt table entry
of device*

EXEC MODULE DOUBLET TABLE FORMAT

(TWO WORDS PER DISC RESIDENT EXEC MODULE)

WORD
#1

# SECTORS - 1	EXEC MODULE ID #
15-11	10-0

WORD
#2

START TRACK #	START SECTOR #
15-8	7-0

SYSTEM DIRECTORY LISTING FOR DOSM GENERATION EXAMPLE

NAME	TYPE	SCTRS	DISC	ORG	PROG	LIMITS	B.P.	LIMITS	ENTRY	LIBR.	P-BIT
SUBCHAN=1											
SEX03	XS	0002	T001	011	07567	07624	00732	00733	07567	07624	
SEX04	XS	0004	T001	013	07567	10176	00732	00741	07567	10176	
SEX05	XS	0002	T001	017	07567	07745	00732	00733	07567	07745	
SEX07	XS	0002	T001	019	07567	07746	00732	00733	07567	07746	
SEX08	XS	0002	T001	021	07567	07732	00732	00733	07567	07732	
SEX09	XS	0003	T001	023	07567	10142	00732	00763	07567	10142	
SEX10	XS	0002	T002	002	07567	07745	00732	00733	07567	07745	
SEX12	XS	0002	T002	004	07567	07761	00732	00733	07567	07761	
SEX13	XS	0004	T002	006	07567	10223	00732	00754	07567	10223	
SEX14	XS	0004	T002	010	07567	10241	00732	00751	07567	10241	
SEX15	XS	0003	T002	014	07567	10153	00732	00763	07567	10153	
SEX16	XS	0002	T002	017	07567	07722	00732	00733	07567	07722	
SEX19	XS	0003	T002	019	07567	10107	00732	01000	07567	10107	
SEX20	XS	0003	T002	022	07567	10167	00732	00761	07567	10167	
DVR01	DR	0003	T003	001	10241	10555	01000	01002	10241	10555	
DVR02	DR	0003	T003	004	10241	10443	01000	01002	10241	10443	
DVR22	DR	0005	T003	007	10241	11075	01000	01002	10241	11075	
LOADR	UM	0032	T003	012	12000	21032	01002	01425	12000	21032	
JOBPR	UM	0038	T004	020	12000	22463	01002	01414	12000	22463	
ASMB	UM	0023	T006	010	12000	17120	01002	01362	16522	17120	
ASMBD	US	0004	T007	009	17127	17647	01362	01363	17442	17647	
ASMB1	US	0006	T007	013	17366	20542	01362	01424	17366	20542	
ASMB2	US	0007	T007	019	17345	20550	01362	01410	17351	20550	
ASMB3	US	0003	T008	002	17473	17771	01362	01363	17630	17771	
ASMB4	US	0004	T008	005	17366	20027	01362	01371	17366	20027	
ASMB5	US	0006	T008	009	17345	20425	01362	01404	17351	20425	
FTN	UM	0006	T008	015	12000	13127	01002	01047	12000	13127	
FTN01	US	0031	T008	021	13254	22120	01047	01502	16550	22120	
FTN02	US	0025	T010	004	13254	21027	01047	01356	13741	21027	
FTN03	US	0024	T011	005	13254	20600	01047	01277	15117	20600	
FTN04	US	0025	T012	005	13254	20750	01047	01360	13702	20750	
LIBRY	LB	0147	T013	007							

EQUIPMENT TABLE LISTING

```

:EQ
EQT 01 CH 11 DVR05 0 R U0 S0
EQT 02 CH 13 DVR01 0 0 U0 S0
EQT 03 CH 14 DVR31 D R U0 S0
EQT 04 CH 16 DVR02 0 0 U0 S0
EQT 05 CH 22 DVR22 D 0 U0 S0

```

LOGICAL UNIT TABLE LISTING

```

:LU
LU01 EQT01
LU02 EQT03
LU03 EQT03
LU04 EQT04
LU05 EQT02
LU06 EQT01
LU07 EQT05
e

```

MEMORY DUMP FOR DOSM SYSTEM GENERATION EXAMPLE

CORE DUMP: 000004-007566

53213

000000:	114532	114532	114532	114532	114532	114532	114532	114532	TRAP GEN
000020:	114532	114532	114532	114532	114532	114532	114532	114532	J5B \$CZ
000030:	114532	114532	114532	114532	114532	114532	114532	114532	bc. 1685
000040:	177700	177766	177767	177770	177771	177772	177773	177774	CONSTANT
000050:	177775	177776	177777	000000	000001	000002	000003	000004	
000060:	000005	000006	000007	000010	000011	000012	000021	000100	
000070:	000017	000037	000077	000177	000377	177400	003777	177700	
000100:	037633	000000	000000	000012	000000	000000	000000	000000	
000110:	000000	000001	000001	000000	000003	013000	000030	007361	Str. of eq. link
000120:	000005	007566	000007	000000	000000	000000	000000	000000	
000130:	000000	000000	000000	037634	000000	000000	000000	000000	
000140:	000000	000000	000000	000000	000000	000000	000000	000000	
000150:	000000	000000	000000	000000	000000	000000	000000	000000	
000160:	033403	000001	000000	000377	060307	000001	000001	033403	
000170:	000046	000000	000000	000000	000026	000000	001005	000000	
000200:	013000	007515	000016	007361	013001	000001	021450	000000	CURRENT EQT TABLE ADDRESSES
000210:	007366	007367	007370	007371	007372	007373	007374	007375	
000220:	007376	007377	007400	007401	000000	000000	000000	000000	
000230:	000000	000000	000000	000000	000000	000000	000000	000000	
000240:	177777	077777	003327	007533	000016	000000	007567	010241	
000250:	000732	001000	010241	001000	012000	001002	001633	000006	
000260:	000000	000001	000000	002024	010463	000412	000000	000000	
000270:	046102	042117	021450	050521	050521	050421	044456	031461	SYSTEM I/O BUFFER
000300:	020000	036173	000723	041456	031461	020000	036173	000724	
000310:	044456	031062	020000	036164	000000	041456	031062	020000	
000320:	036164	000000	046117	040504	051000	036155	000000	163252	
000330:	041120	051000	036146	000000	040523	046502	020000	036137	
000340:	000000	037501	051503	047000	036137	000000	037501	051515	
000350:	041000	036137	000000	037502	047103	047000	036137	000000	
000360:	037502	050113	052400	036137	000000	037503	044117	050000	
000370:	033403	000000	000312	001534	177610	020040	020040	020040	
000400:	030471	027117	041524	027067	030040	000000	000000	000000	
000410:	000000	000000	000000	000000	000000	000000	000000	000000	
000420:	000003	000004	000002	000001	000005	000000	000000	050521	
000430:	050521	050421	044456	031461	020000	037515	051531	046400	
000440:	036137	000000	037522	046125	047000	036137	000000	037501	
000450:	043114	043400	036137	000000	037514	051524	046000	036137	
000460:	000000	037514	052516	044400	036137	000000	037522	051502	
000470:	000000	042101	000000	000000	000000	000000	000000	007552	
000500:	177771	000000	000000	000000	000000	003463	000000	000000	
000510:	000000	177750	000000	000000	000000	177777	177777	077777	
000520:	003327	000000	006407	000120	000001	000000	000000	000000	
000530:	114532	000000	001634	004160	004154	002214	003400	003511	Sys. link
000540:	003020	002635	003744	003361	003426	004165	004267	002507	DISC. ENT POINTS LINKS
000550:	004010	003244	003345	003177	001714	003563	004044	002212	
000560:	002653	002657	002661	002663	002665	002553	003214	003207	
000570:	003143	002576	002700	002631	002521	003130	003117	004243	
000600:	002445	004302	004303	004314	004376	000000	000000	000000	EXEC. ENT POINTS
000610:	004446	000000	000000	000000	000000	004505	000000	000000	
000620:	000000	000000	000000	004671	005264	000000	000000	002322	
000630:	002222	002637	004262	004151	001746	004034	004125	004304	DISC. ENT PAGE LINKS
000640:	004305	001736	001726	001723	004300	004301	004307	004272	
000650:	004312	004313	004310	004311	004274	004150	004126	004127	
000660:	004135	004124	004005	004024	004136	004035	004137	004277	
000670:	004131	004132	004133	004134	004270	004275	004130	004145	
000700:	004146	004147	003607	002213	003743	103575	003325	002463	
000710:	003204	003213	003220	003236	003003	005774	006011	006206	

DISC RESIDENT I/O DRIVER B.P. LINKAGE

EXEC
SUBROUTINE
LINKS

000720:	006354	006336	006372	105774	006330	006315	006410	006464	
000730:	006560	006743	007567	000000	000000	000000	000000	000000	
000740:	000000	000000	000000	000000	000000	000000	000000	000000	
000750:	000000	000000	000000	000000	000000	000000	000000	000000	
000760:	000000	000000	000000	000000	000000	000000	000000	000000	
000770:	000000	000000	000000	000000	000000	000000	000000	000000	
001000:	010241	011001	012000	017624	020315	022175	022202	015126	
001010:	021023	015342	015465	014302	014733	022213	115037	014623	
001020:	015442	015754	020307	015124	015216	015221	014035	014711	
001030:	020431	020432	014364	020433	020434	020435	015101	015557	
001040:	021237	015623	014027	021051	022017	020443	020444	020445	
001050:	020446	020447	020450	020451	020452	021015	014124	115101	
001060:	014645	020453	015217	015256	017674	017377	017621	017661	
001070:	022263	015753	021173	017625	020427	014435	014370	014353	
001080:	015041	014636	014463	017314	015337	015513	014146	014044	
001090:	014054	014055	014056	014052	014050	014022	014051	014057	
001100:	014060	014061	015040	014045	012262	020524	013761	012725	
001110:	013157	012063	012636	013152	016551	013435	013626	013147	
001120:	013627	013140	013166	016242	013142	013433	013434	013170	
001130:	020426	013161	021647	020757	021016	017427	021001	013126	
001140:	020624	017412	016276	016410	016267	016561	016026	016273	
001150:	013141	016010	013163	015427	012645	015214	020330	020327	
001160:	015755	020320	115427	015341	015317	012103	015460	015445	
001170:	015570	022214	022052	015266	015443	015675	015430	015462	
001180:	015432	015433	015434	021026	015227	015431	021042	013164	
001190:	015756	015343	022326	015624	020323	020324	020325	022264	
001200:	022265	022266	022325	022274	022273	022276	022275	022270	
001210:	022271	022267	022272	022305	022314	022320	022323	022324	
001220:	014432	115442	014434	015131	020274	020015	022176	016415	
001230:	017622	016416	015127	016376	016763	016720	017026	017623	
001240:	015104	016422	017606	022463	022464	016411	016414	017600	
001250:	017157	017156	022203	015444	022205	016417	016420	017632	
001260:	016426	015722	013151	013133	016424	015037	015102	115102	
001270:	016372	013174	016423	015720	022201	022204	022174	022036	
001280:	022177	022207	022062	012722	022212	022210	022206	022211	
001290:	022200	022215	022001	022003	021767	016241	021651	021664	
001300:	013104	013135	012447	013010	016575	021543	021534	021542	
001310:	021541	021540	021461	021474	016721	116721	013154	020527	
001320:	013155	020465	012473	020436	120436	012723	020437	020440	
001330:	020441	020442	014351	020314	012214	012215	012216	021000	
001340:	020777	020653	020757	012213	021023	020043	020057	020206	
001350:	020353	113273	020007	017433	117751	017774	017100	017150	
001360:	017661	017542	017624	113276	017421	017111	017112	017571	
001370:	017077	117112	017423	017107	017424	017422	017110	017106	
001380:	017103	017113	117110	017305	117107	017102	017114	013271	
001390:	013267	017101	013275	017305	117436	021707	021663	021774	
001400:	022034	022062	147722	146701	152240	143317	151240	120302	
001410:	144716	140722	154640	125215	105252	120311	147320	152724	
001420:	120315	140731	120301	146323	147640	141305	120323	142714	
001430:	142703	152305	142240	143317	151240	140640	151711	147307	
001440:	146305	120322	142701	142240	120240	120240	120252	106012	
001450:	125240	147720	142722	140724	144717	147256	120240	120240	
001460:	120240	120240	120240	120240	120240	120240	120240	120240	
001470:	120240	120240	120240	120240	120240	120240	120240	120240	
001480:	120240	120240	120240	120240	120240	120240	120240	120240	
001490:	120240	120240	120240	120240	120240	120240	120240	120240	
001500:	120240	120240	120240	120240	120240	120240	120240	120240	
001510:	120240	120240	120240	120240	120240	120240	120240	120240	
001520:	120240	120240	120240	120240	120240	120240	120240	120240	
001530:	120240	120240	120240	120240	120240	120240	120240	120240	
001540:	120240	120240	120240	120240	120240	120240	120240	120240	
001550:	120240	120240	120240	120240	120240	120240	120240	120240	
001560:	120240	120240	120240	120240	120240	120240	120240	120240	
001570:	120240	120240	120240	120240	120240	120240	120240	120240	
001580:	120240	120240	120240	120240	120240	120240	120240	120240	
001590:	120240	120240	120240	120240	120240	120240	120240	120240	
001600:	070242	163634	170627	102504	033635	073646	103111	106504	
001610:	054057	102004	054060	124630	054103	027754	044045	074000	

EXEC MO.
DESC RE
LINKAGE

USER
BASE
PAGE
LINKAGE

DISCM
Core resident

DISCM

001660:	002020	027714	003000	040202	002020	027714	044201	160001
001670:	002003	027714	114552	102504	164204	114001	027776	060260
01700:	002003	027714	060261	002002	027714	160557	164201	006003
01720:	002002	027714	074260	124544	063634	017746	002001	027722
001730:	017726	127634	017726	102100	102705	127634	001721	060241
001740:	103101	000036	102101	060237	064240	127726	001637	070237
001750:	074240	001520	102201	002004	070241	127736	002106	003000
001760:	040254	002020	037746	127746	034105	027761	063775	070105
001770:	034104	060106	002020	027714	034107	027714	063775	070107
001780:	034106	060106	050110	124531	027714	170650	170217	070531
002000:	174220	017331	060513	003004	050203	070513	060262	000010
002010:	026070	060141	002003	026070	160212	002020	003004	050054
002020:	002001	026070	007400	044111	044121	003400	140001	114632
002030:	040117	050203	002001	026070	160214	160000	010075	150633
002040:	002001	026070	160211	114634	026070	060123	072052	160214
002050:	066207	017361	002052	160220	164215	006021	026061	002004
002060:	001100	070530	160206	012211	170206	160211	070242	026651
002070:	160217	002002	026152	160206	012211	170206	160213	012210
002100:	002002	026163	160211	070505	164220	114634	026150	164635
002110:	154636	026204	060260	002003	026143	003400	140121	114632
002120:	040117	040056	160000	002020	026143	062212	002002	026141
002130:	160206	070237	164220	074240	160211	070242	006400	074260
002140:	027426	006400	074260	164220	160206	102100	102705	124505
002150:	160206	124505	050056	002301	026641	160206	110637	150640
002160:	026644	060056	026641	063213	002003	026171	060513	002021
002170:	027256	160205	010072	053204	027244	063220	002003	124554
002200:	017003	027271	124554	027271	060203	072213	027244	177734
002210:	020000	037777	000000	000000	000000	103100	114641	062214
002220:	040052	002001	102505	070512	070242	072424	036424	160000
002230:	012473	052475	002001	026633	160512	012474	160000	052476
002240:	002001	026315	066424	160001	114634	026635	160001	070225
002250:	007004	040001	002003	026635	040052	070224	002020	026635
002260:	040042	002021	026635	064043	002400	017361	000226	064224
002270:	007004	036424	062266	070505	162424	016507	170505	034505
002300:	036424	006006	026274	160226	052500	002001	026325	114642
002310:	170001	006004	102100	102705	124225	052477	026320	026633
002320:	114642	114577	007400	134532	124643	002003	026635	052501
002330:	124534	052502	026346	052503	026340	052504	026425	026362
002340:	060237	072342	000000	026312	034105	026312	060103	002003
002350:	026344	032505	072357	060103	032506	072360	060056	000000
002360:	000000	026312	002021	003004	042461	002020	026635	160226
002370:	002020	003004	070514	050064	026400	050065	002001	026402
002380:	060063	070514	050060	026312	042436	160000	050052	026635
002410:	052437	026431	070474	062462	070475	002404	064514	154475
002420:	027020	002004	034475	026417	000000	160644	070474	060066
002430:	027020	006400	160645	070474	062470	027020	002436	002431
002440:	002431	002431	100612	177777	100605	100606	100607	100607
002450:	100607	100611	177777	002431	002431	002431	100603	100604
002460:	100610	000022	002463	000020	000021	000006	000007	000010
002470:	000022	000013	000004	176000	001777	114000	002214	004243
002500:	177755	177754	177753	177752	000027	102600	103700	000000
002510:	002003	026635	050054	026635	001275	002001	126507	160200
002520:	026510	140646	070514	060232	070472	066552	074473	160647
002530:	070474	062471	027020	006003	026665	060514	050055	002001
002540:	026432	060001	040055	160000	010071	050065	026432	052471
002550:	026432	026631	002533	004172	010072	002003	026653	007400
002560:	044000	003004	040122	002020	026653	044121	160001	002003
002570:	026655	040052	114632	040117	017345	126553	000000	164226
002600:	174212	006020	007004	060225	170211	160227	050050	003004
002610:	170213	060230	054056	160230	170214	160231	170215	060232

DISCM

002620:	154650	026625	154651	026625	160232	170216	160233	170217
002630:	126576	006400	026670	064054	026670	064055	026670	064056
002640:	026670	064057	070473	026670	007400	170206	016776	164652
002650:	026670	164653	026670	064060	026670	064061	026670	064062
002660:	026670	064063	026670	064064	026670	064065	060512	002001
002670:	060242	070472	002400	070245	160654	070474	160653	027020
002700:	004241	160205	002021	026723	060061	070257	017003	026721
002710:	026717	160206	110637	150640	026717	034257	026721	060060
002720:	026774	060203	170001	160213	010077	070001	160212	002020
002730:	003004	150650	026740	150651	026742	030001	170213	026744
002740:	002404	026735	060055	026735	160205	010072	164203	114001
002750:	070510	002102	026766	160205	001222	000010	026762	060513
002760:	003004	070513	160206	130655	170206	126700	050056	002300
002770:	017331	006440	016776	060510	036700	126700	000000	060526
003000:	002003	126776	124000	002707	064201	002400	150001	027017
003010:	060165	002002	027016	005004	150001	037003	037003	127003
003020:	073116	077115	060243	070477	060244	002003	124474	003004
003030:	070500	060245	002020	027222	053116	027110	160477	010074
003040:	053116	027047	034477	034477	034500	027036	124474	003004
003050:	070245	064246	074167	007004	044247	074170	160477	001722
003060:	010071	034477	164477	074166	036212	002003	027106	001722
003070:	001222	070001	003004	040170	002021	074170	017117	060174
003100:	070166	064250	074167	007004	044251	074170	017117	072212
003110:	067115	063116	003004	070245	124246	000001	000014	003107
003120:	060166	017130	063127	006404	017400	002400	127117	000166
003130:	003122	006400	114577	177770	060154	010074	003004	044000
003140:	006021	026663	127130	000000	070513	064252	074167	007004
003150:	140650	144000	074170	040055	160000	070166	017117	060174
003160:	070166	064253	007004	060513	140651	144000	006003	127143
003200:	060253	070167	036212	074170	017117	072212	127143	073204
003210:	077206	060206	073205	027244	000000	000000	000000	000000
003220:	060203	073213	027244	000000	073221	060203	073220	027244
003230:	000000	000000	037236	063115	073240	063116	073237	060474
003240:	073241	060472	073242	060473	073243	027244	000000	000000
003250:	000000	000000	000000	000000	063204	002003	027256	163205
003260:	001222	010056	002002	027256	073204	127206	063213	002003
003270:	027271	060513	002020	027271	063213	017345	002400	073213
003280:	127207	063220	002003	027304	017003	027277	027304	063220
003300:	017345	002400	073220	127221	063236	002003	027325	060245
003310:	002020	027325	002400	073236	063242	070472	063243	070473
003320:	063241	070474	063237	067240	027020	102100	003400	007400
003330:	027325	002002	064201	060203	150001	027342	006004	150001
003340:	002001	127331	002400	170001	127331	002575	067360	074474
003350:	067357	170001	002004	006004	034474	027351	127345	000203
003360:	177757	000000	070503	074505	167361	074504	037361	006400
003370:	002002	164503	174504	034503	034504	034505	027367	127361
003400:	007675	077412	064203	077423	073424	060055	073413	063424
003410:	073414	114545	000001	000002	007726	000000	003420	027244
003420:	063423	017345	127400	000000	007726	000000	077561	017563
003430:	034261	067561	063556	006002	063553	073441	114545	000002
003440:	000001	003554	000002	003463	063561	002002	027244	060520
003450:	114634	027244	060517	103101	000036	102101	060515	064516
003460:	102100	102705	124520	017563	060123	073471	114545	000001
003470:	000401	037634	000044	003475	027444	077562	017563	002400
003500:	070261	067562	017575	060471	150656	027430	150657	027430
003510:	027444	060111	050054	027544	073532	064123	077533	016553
003520:	160205	001222	000010	027530	060203	050513	002001	017143
003530:	114545	000001	003532	003533	000044	003537	027244	160123
003540:	010075	150633	017575	027511	060261	002003	027551	034260
003550:	027244	007400	027426	003554	006412	040137	003557	006412

DISCM

003560:	025137	177777	000000	003464	060237	070515	060240	070516
003570:	060241	070517	060242	070520	127563	000000	074530	074472
003600:	067575	074473	064123	160001	010075	150633	027631	034261
003610:	114545	000002	000001	004140	177770	003625	064471	154656
003620:	027244	060020	114634	124854	027452	002400	070261	017563
003630:	127575	160001	006004	164001	114577	177770	170635	064471
003640:	154660	027677	150661	124662	150636	124663	150664	124665
003650:	150666	124662	154656	002001	027702	150656	006401	027714
003660:	074471	062213	002002	027670	160667	070474	062463	027020
003670:	076213	150656	027447	017345	160211	070505	026141	150650
003700:	027743	027607	154657	027736	006002	027607	064262	004010
003710:	027714	064141	006003	027743	150670	027731	150671	027725
003720:	150672	027731	150673	027731	027607	160674	070474	060064
003730:	027020	160675	070474	160650	064530	027020	150657	027743
003740:	150676	027743	027607	002400	114556	002404	070262	160677
003750:	070141	160700	070142	160701	070143	060263	070166	060254
003760:	070167	060264	070170	017117	060174	070166	060255	070167
003770:	060265	070170	002400	070471	017117	002400	070261	070260
004000:	064530	070530	102100	102705	124254	060112	070111	006400
004010:	074475	060106	032150	070106	016044	070262	070245	062276
004020:	070474	064475	062313	124540	064242	074470	062126	050471
004030:	124702	070471	170703	124544	000000	060141	002003	124704
004040:	060262	032150	070262	124705	000000	060120	003004	070474
004050:	074475	064117	044055	160001	010072	032144	072076	006004
004060:	160001	001265	012304	052305	002041	026073	062072	044056
004070:	170001	124706	004045	052153	032152	170001	107700	144707
004100:	034474	026053	102106	107706	102107	107707	064201	002400
004110:	170001	070513	170710	170711	170712	170713	070261	070260
004120:	170703	006004	170001	126044	040502	050101	043517	045117
004130:	042512	046125	042521	052520	042116	042101	052131	047506
004140:	044507	047117	051105	042040	107700	045117	041120	051040
004150:	100000	035000	000040	000400	062271	070474	060065	124540
004160:	106700	062273	070474	062310	124540	003474	062165	002004
004170:	160000	114565	160206	001222	010056	002003	026204	007400
004200:	046165	160205	010072	124553	160206	012304	062305	002001
004210:	026217	114714	026217	003401	003400	042165	124566	162165
004220:	002021	003004	170212	036165	162165	170213	036165	162165
004230:	170214	036165	162165	170215	036165	162165	170211	036165
004240:	114572	126168	026240	003134	072260	162243	072261	062260
004250:	036243	000066	005600	002040	002004	036261	026251	126243
004260:	001005	000000	002573	070001	001700	040001	126262	000470
004270:	100613	100614	100615	100616	100617	100620	100621	100622
004300:	100623	100624	100625	100626	037400	014400	177764	177763
004310:	000014	000015	000016	000017	060224	040047	002002	026373
004320:	060231	114715	160226	002020	026353	060160	006400	114577
004330:	177770	002002	006004	007004	144230	006021	026341	006400
004340:	026365	006400	060154	010074	003000	140227	140230	002003
004350:	026353	002021	026365	164230	144227	007004	060154	010074
004360:	002004	040001	002020	026337	164230	174231	002400	070245
004370:	102100	102705	124225	002400	070245	124541	060224	040047
004400:	002002	026443	060227	114715	060230	114715	060231	114715
004410:	060160	006400	114577	177770	002002	006004	174227	060102
004420:	002003	026431	006400	114577	177770	002002	044052	074000
004430:	026433	060154	010074	170230	060116	170231	002400	070245
004440:	102100	102705	124225	002400	070245	124541	060050	040224
004450:	002002	026502	060230	114715	064227	034162	060200	002004
004460:	114716	026477	064227	060114	114716	026477	002400	170230
004470:	002400	070245	044052	160001	102100	102705	124225	044057
004500:	160001	026467	002400	070245	124541	060472	072664	060473
004510:	072665	060245	052666	026537	060262	002002	026601	060525

\$EX01

\$EX02

\$EX06

\$EX11

004520:	166663	056670	002003	026601	066647	076641	062664	114717
004530:	026614	066641	044063	076641	056663	026605	026526	062664
004540:	066577	114717	026556	062664	066573	114717	026562	034162
004550:	060200	002004	066664	114716	026567	005401	066577	002400
004560:	070245	126655	062573	064046	114543	000270	066647	076664
004570:	062577	064046	114543	000133	062664	064046	114543	000126
004600:	026556	002400	066667	114543	000270	034162	060200	002004
004610:	066664	114716	026630	026555	066641	044060	160001	070161
004620:	006004	160001	070157	006004	160001	070200	066641	026567
004630:	076664	062663	040043	062647	026644	072641	040043	064043
004640:	114543	000000	062641	026632	062664	064046	114543	000270
004650:	060161	070275	060157	070276	060200	070277	062670	172663
004660:	034525	066647	026567	000460	000000	000000	177765	177607
004670:	022124	026707	062771	002020	026772	062704	006002	062705
004700:	070473	017250	064057	027051	047122	050105	004672	060161
004710:	073261	060200	073262	064224	044047	006024	026724	160231
004720:	050054	027074	002024	027120	062706	070526	060156	003000
004730:	006021	160230	072771	002020	027013	070161	017215	017126
004740:	063030	114721	026747	064227	017200	027025	027101	160227
004750:	002003	027043	010075	053000	027101	027043	062771	003000
004760:	070161	017215	063030	114721	027001	064227	017200	026772
004770:	027006	000000	036771	026756	063162	066777	027045	177756
005000:	025000	160227	010075	053000	027006	026772	060262	002002
005010:	017230	017126	027101	160227	002002	026756	072771	017230
005020:	017215	017126	063030	114721	027043	063031	064041	027045
005030:	005034	005032	046102	046075	000000	000000	000000	005040
005040:	052516	046102	046040	063037	064046	114722	017250	064055
005050:	047154	002400	073154	070526	070245	160600	070474	060057
005100:	124540	006400	074245	074026	063154	002002	027050	063263
005110:	102100	102705	124225	005046	160230	070161	063073	070526
005120:	017215	006400	077263	074126	074133	067177	017200	027115
005130:	006404	060370	070200	063227	114720	064370	074157	027061
005140:	070245	160601	070474	063125	124540	000023	000000	060176
005150:	050272	027136	070472	060272	070473	037154	060271	053156
005160:	127126	067161	053156	067157	057161	063160	073164	077165
005170:	063163	064043	114722	127126	000000	042117	052123	041040
005180:	037477	037440	005166	005164	000000	000000	042111	051503
005190:	020116	047524	020117	047040	051531	051524	042515	005174
005200:	000000	160001	050273	006005	127200	160001	050274	006005
005210:	127200	160001	050275	037200	127200	000000	006400	060161
005220:	050155	064115	074200	063227	006404	114720	127215	000200
005230:	000000	060161	033241	001727	073247	063242	064042	114722
005240:	127230	000060	005243	051525	041103	044101	047075	000000
005250:	000000	063261	070161	063262	070200	060074	070163	073263
005260:	127250	000000	000000	000000	006002	027700	160227	064161
005270:	077314	050050	003004	114565	060514	053313	002001	027335
005300:	017766	160206	170230	064224	054056	027310	164220	174231
005310:	102100	102705	124225	000015	000000	000000	040201	040045
005320:	073766	164000	006003	027331	044055	160001	010072	053334
005330:	002001	037315	060203	127315	000000	160205	010072	073334
005340:	017315	027356	063334	002004	017315	027356	060061	017315
005350:	027356	060062	017315	027356	102000	027354	006004	160001
005360:	064514	054056	027411	061222	010056	002003	027411	050054
005370:	027402	050055	027376	063375	124566	005266	017766	063334
005380:	064512	124553	060512	070470	063410	070471	017766	124544
005390:	043517	063334	017315	173766	063334	002004	017315	173766
005400:	160205	001222	000010	027427	064513	006020	114567	060514
005410:	050054	027435	050055	027435	027443	160227	050050	003004
005420:	010072	050056	034162	114571	160226	002021	027462	160206
005430:	013456	053457	027565	027667	017766	124574	037400	014400

\$EX11

\$EX17

\$EX18

005460:	000016	000017	060514	050056	027667	064230	007000	044254
005470:	006021	124561	017756	044230	002040	124562	007004	044100
005480:	006020	124562	160206	013456	053457	002001	027667	060514
005490:	053460	027454	053461	027454	060102	002003	027523	001727
005500:	010074	040052	027525	060154	010076	070505	060100	006400
005530:	114577	177770	002002	006004	160232	010074	170232	003000
005540:	040001	002021	124563	063755	006400	114577	177767	002002
005550:	006004	144233	002400	044511	006020	027560	002004	027553
005560:	140232	003004	040505	002020	124563	160233	040511	002021
005570:	124563	160232	001727	130233	070171	060230	070172	160231
005580:	070173	060224	040045	002002	124560	060055	114565	114571
005610:	064177	160227	050050	074161	063753	170214	114572	027654
005620:	067314	074161	050060	027642	050055	027650	050056	002001
005630:	027645	060203	070472	160600	070474	017766	067641	060057
005640:	124540	000022	063644	124566	005616	050057	002001	124573
005650:	017766	160206	006400	027310	017766	063314	070161	160227
005660:	050050	003004	013666	002003	124551	027310	020000	160205
005670:	001222	000010	027616	060203	050513	027616	114570	027616
005700:	160233	003004	067754	074504	044057	140001	070505	017756
005710:	060161	073314	006400	063755	114577	177747	006002	002004
005720:	003004	040505	002020	124564	064504	044056	160001	006400
005730:	114577	177770	077756	001727	140233	070505	040511	002020
005740:	027744	037756	070505	027736	067756	005727	060505	030001
005750:	070171	034162	027575	000171	000126	000000	000000	164231
005760:	006121	027764	005100	007004	077755	127756	000000	060245
005770:	002020	003004	070245	127766	000000	003000	070001	040254
006000:	002021	026006	044100	006020	026006	124723	002400	070245
006010:	124541	000000	072125	076126	060161	072107	060162	072125
006020:	002400	070162	072130	060115	040075	064055	016252	016136
006030:	062123	002003	026114	064527	056057	026111	006020	026060
006040:	004065	006043	026111	076131	002041	026054	062130	052107
006050:	026054	016202	026054	016136	036130	066131	026040	047117
006060:	060150	003000	072130	062130	003000	052107	026072	016202
006070:	026072	016136	036130	026063	026111	062124	066110	114543
006100:	006123	060161	052107	026115	002400	070126	026115	000000
006110:	177765	062107	016202	000000	036011	060115	040075	006404
006120:	016252	066100	126011	000000	000000	000000	000000	000000
006130:	000000	000000	000000	000000	000000	000000	000000	062125
006140:	016244	002264	072124	062126	066124	016266	026075	066124
006150:	044055	160001	010073	040045	002020	044061	044056	076124
006160:	007000	144546	006020	026172	162124	002003	126136	050052
006170:	002001	026143	036125	062125	010073	003004	040116	002002
006180:	026137	126136	000000	070161	060074	070163	062237	070526
006190:	002400	070200	016244	062241	050273	060274	052242	060275
006220:	052243	002001	026226	060370	070200	016244	060370	070157
006230:	060200	002004	072125	036202	002400	070526	126202	006240
006240:	026234	051531	051524	042515	000000	066123	074162	006404
006250:	016252	126244	000000	070166	062264	070167	062263	070170
006260:	062265	114536	126252	000200	000270	000166	000000	072127
006270:	160001	152127	002001	026313	006004	036127	160001	152127
006300:	002001	026313	006004	036127	162127	010075	072127	160001
006310:	010075	052127	002001	036266	126266	000000	062327	072334
006320:	003400	066370	120001	000004	036332	026322	126315	177741
006330:	000000	076334	064050	114543	000000	126330	000000	064000
006340:	062352	016330	060270	052353	002001	126336	016315	050327
006350:	036336	126336	000273	046102	000000	070170	076334	064200
006360:	074166	062370	070167	062371	066334	034162	114536	126354
006370:	000270	000166	000000	072401	076402	034261	114545	000002
006400:	000001	000000	000000	006405	124551	002400	070261	126372
006410:	002750	160213	010056	050056	026431	032633	002311	001425

\$ADDR

\$SRCH

\$LBL

DVR05

DVR05

006420:	102611	016446	000015	016464	102711	002400	170220	126410
006430:	006424	120213	052577	026436	060057	126410	104214	006021
006440:	007004	174217	005300	174214	060055	026415	006422	164214
006450:	005200	174216	164215	007324	005010	007004	001310	026462
006460:	006003	007400	174217	126440	001670	062404	002400	026476
006470:	160206	002020	026476	034260	036464	126464	164213	005332
006500:	026611	102511	010073	050073	026541	052422	026537	050065
006510:	026562	006020	026537	050054	026544	164216	004065	134216
006520:	002041	001727	072446	060074	002340	001727	110001	032446
006530:	170001	160213	001421	134217	000040	001425	170213	036464
006540:	026606	016446	160213	026536	016553	044052	174216	160217
006550:	040052	170217	026537	000000	160214	001000	150216	026537
006560:	164216	126553	005421	174213	016553	004065	160001	010075
006570:	032534	002040	170001	160217	164215	002004	006021	001100
006600:	006020	007300	044000	100711	001521	102011	103711	002400
006610:	126464	062464	052430	026621	102011	010074	060074	026621
006620:	070260	002400	150216	020074	150217	026640	160216	134216
006630:	000065	004010	062630	160000	006051	001727	010074	134217
006640:	026643	052657	026574	102611	026537	062422	150220	060065
006650:	170220	052422	026643	006400	174216	026643	004000	000137
006660:	002750	064162	060155	006002	060161	073360	000065	073347
006670:	002441	063344	073352	060164	006002	060163	073353	063347
006700:	017211	000400	010067	002102	026737	160213	010056	001510
006710:	026714	067145	063336	026727	063337	002341	026726	160213
006720:	010077	001225	053340	026726	060057	126660	067332	077062
006730:	073346	060041	170220	062736	072743	026764	006737	060056
006740:	006400	074162	126660	001676	063347	100515	006003	026755
006750:	002400	004033	026755	002004	026751	017211	027115	067333
006800:	106606	164217	124001	000764	164214	006004	160001	002003
007000:	027071	073354	006004	160001	002021	003005	001100	002003
007010:	003400	073355	044051	160001	010075	073350	120001	073351
007020:	003004	040116	001727	001300	043355	002020	027034	001727
007030:	001200	010074	003004	040116	050116	002701	043350	070174
007040:	002400	006004	170001	027051	044055	003004	170001	043355
007050:	073355	044052	003004	043354	170001	044052	063350	042701
007060:	170001	017126	017241	067354	063346	063336	047343	106702
007070:	106602	067355	103714	017162	017241	063346	053337	017172
007080:	026764	060200	002302	000040	060162	067353	002041	002003
007100:	074164	002041	002002	074163	002400	070162	164215	006020
007110:	007004	126743	007171	063112	170217	002400	036743	126743
007120:	007167	033347	106715	102615	103715	127120	007052	063351
007130:	043335	002021	032701	002020	043334	033352	070001	063350
007140:	001767	017143	127126	007142	102614	103714	053353	002300
007150:	073353	063341	001225	017120	102314	027154	106614	103714
007160:	017112	127143	007064	102702	106602	103706	017120	106706
007170:	017112	127162	000000	017126	063355	003004	040073	001727
007200:	001200	010071	102614	103714	063342	017120	017112	017241
007210:	127172	006757	102106	103714	106715	102615	103715	102314
007220:	027217	102514	073357	010074	073356	063357	001226	002440
007230:	027237	160206	010075	033356	170206	037211	127211	070525
007240:	127211	007065	063357	002111	127241	001422	001727	000010
007250:	027262	001723	000312	027305	057340	127241	134220	027276
007260:	001200	002021	002405	060056	006400	074162	067350	074126
007270:	067351	074130	067350	074127	005727	126743	063252	006500
007300:	017143	002400	006500	017143	027051	001332	027315	067346
007310:	057336	027254	027313	102031	027104	017126	067345	106702
007320:	106602	063336	007400	103714	017162	063350	010075	073350
007330:	034525	027051	102114	120014	000014	177764	020000	010000
007340:	110400	030000	060000	100000	001000	107350	020000	000000
007350:	013000	000000	000000	000026	000270	177600	000000	100000

DVR31

730

007360:	000001	006410	006464	040011	102400	000000	000000	003475	
007370:	177777	000401	037634	000044	077470	177670	000000	000000	DVR05
007400:	000000	000000	010241	010313	000013	000400	000000	000000	DVR01
007410:	000000	000000	000000	000000	000000	000000	000000	000000	DVR01
007420:	010555	001002	001401	000000	000743	140014	014400	000000	DVR03
007430:	000000	003420	177777	000001	007726	000000	000000	000000	DVR02
007440:	000000	000000	000000	000000	010241	010320	000016	001000	DVR02
007450:	000000	000000	000000	000000	000000	000000	000000	000000	DVR02
007460:	000000	000000	010443	001002	001404	010241	011001	100022	DVR02
007470:	011000	000000	000000	000000	000000	000000	000000	000000	DVR02
007500:	000000	000000	000000	011075	001002	001407	000001	000003	DAT
007510:	000003	000004	000002	000001	000005	000006	000007	000000	DAT
007520:	007361 ¹¹	000000 ¹²	007402 ¹³	000000 ¹⁴	007423 ¹⁵	007444 ¹⁶	000000 ¹⁷	000000 ¹⁸	INT. TABLE
007530:	000000 ²¹	000000 ²²	007465 ²³	004003	000413	014004	000415	004005	EXEC MOD.
007540:	000421	004007	000423	004010	000425	010011	000427	004012	DOUBLET
007550:	001002	004014	001004	014015	001006	014016	001012	010017	TABLE
007560:	001010	004020	001021	010023	001023	010024	001026		

